



**User Manual**

**PC Cards cifX**

**PCI (CIFX 50)**

**PCI Express (CIFX 50E)**

**Low Profile PCI Express (CIFX 70E, CIFX 100EH)**

**Installation, Operation and Hardware Description**

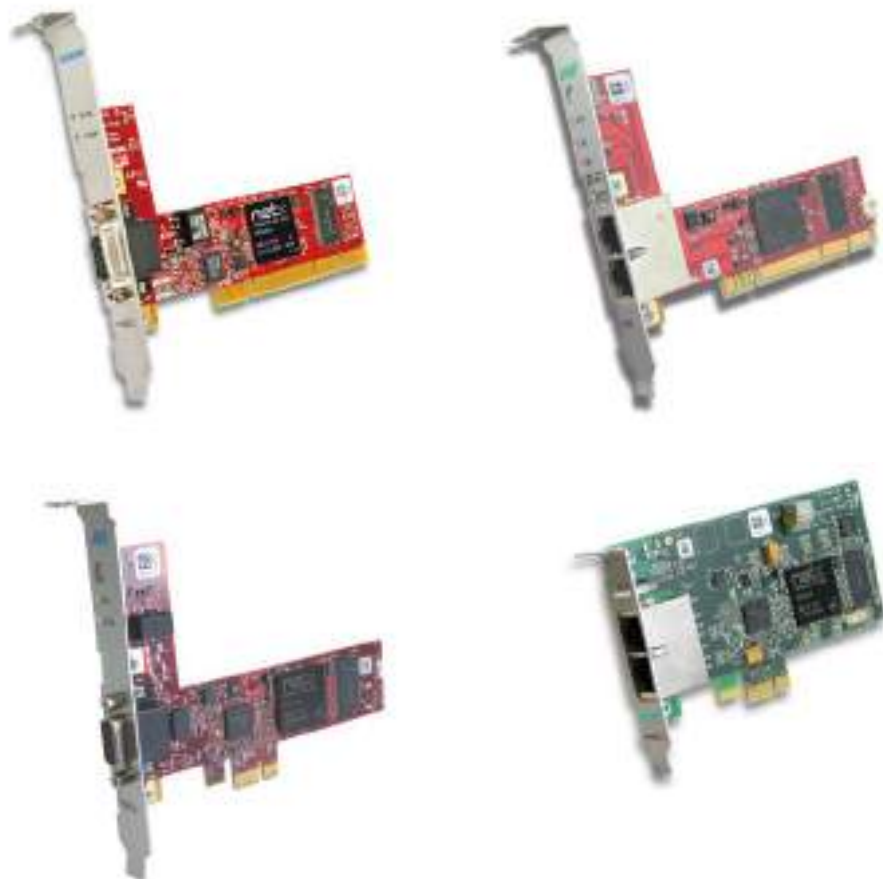

**Hilscher Gesellschaft für Systemautomation mbH**

**[www.hilscher.com](http://www.hilscher.com)**

DOC120204UM53EN | Revision 53 | English | 2019-08 | Released | Public

# Table of Contents

1	INTRODUCTION.....	8
1.1	About the User Manual.....	8
1.1.1	List of Revisions .....	9
1.1.2	Notes on Hardware, Firmware, Software and Driver Versions .....	10
1.1.3	Conventions in this Manual .....	13
1.1.4	Used Terminology .....	13
1.2	Contents of the Product DVD .....	14
1.2.1	Installation Guide, Documentation Overview .....	14
1.2.2	What's New.....	14
1.2.3	Important Changes .....	14
1.2.4	Device Description Files PC Cards cifX .....	21
1.3	Legal Notes.....	23
1.4	Registered Trademarks.....	26
1.4.1	EtherCAT Disclaimer .....	27
1.5	Obligation to read and understand the Manual .....	27
1.6	Licenses.....	27
1.6.1	License Note about VARAN Client.....	27
2	SAFETY .....	28
2.1	General Note.....	28
2.2	Intended Use.....	28
2.3	Personnel Qualification .....	29
2.4	Safety Instructions.....	29
2.4.1	Electrical Shock Hazard .....	29
2.4.2	Communication Stop during Firmware Update or Configuration Download .....	30
2.4.3	Mismatching System Configuration.....	30
2.5	Property Damage .....	31
2.5.1	Exceeding permissible Supply Voltage .....	31
2.5.2	Exceeding permissible Signaling Voltage .....	32
2.5.3	Electrostatically sensitive Devices.....	32
2.5.4	Power Disconnect while downloading Firmware or Configuration .....	33
2.5.5	Exceeding the maximum Number of allowed Write/Delete Accesses .....	33
2.5.6	Invalid Firmware .....	34
2.5.7	Information and Data Security.....	34
2.6	Labeling of Safety Messages .....	35
2.7	References Safety.....	35
3	DESCRIPTIONS AND REQUIREMENTS .....	36
3.1	Description .....	36
3.2	PC Cards PCI CIFX 50-XX.....	36
3.3	PC Cards PCI (2 Channels) CIFX 50-2XX, CIFX 50-2XX\XX .....	37

3.4	PC Cards PCI Express CIFX 50E-XX, CIFX 70E-XX, CIFX 100EH-RE\CUBE .....	37
3.5	PC Cards PCI Express (2 Channels) CIFX 50E-2XX, CIFX 50E-2XX\XX .....	38
3.6	The Function „Slot Number (Card ID)“ .....	39
3.6.1	Requirements „Slot Number (Card ID)“ .....	39
3.7	The Function „DMA Mode“ .....	41
3.7.1	Requirements „DMA Mode“ .....	41
3.8	PC Cards cifX with additional MRAM .....	42
3.9	System Requirements .....	43
3.9.1	Slot for the PC Cards cifX PCI, PCIe and Low Profile PCIe .....	43
3.9.2	Power Supply and Host Interface .....	44
3.9.3	Operating Temperature Range for UL Certificate .....	44
3.10	Requirements for Operation of the PC Card cifX .....	45
3.11	Prerequisites for Certification .....	46
3.11.1	PROFINET IO Certification for IRT and SYNC0 Signal .....	46
4	GETTING STARTED .....	47
4.1	Warnings .....	47
4.2	Installation and Configuration PC Card cifX .....	49
4.3	Note on Exchange Service (Replacement Case) .....	53
4.4	Notes for the Configuration of the Master Device .....	53
4.5	Device Names in SYCON.net .....	55
4.6	Update for Firmware, Driver and Software .....	57
5	DEVICE DRAWINGS .....	58
5.1	PC Cards cifX PCI and PCI Express .....	58
5.1.1	CIFX 50-RE, CIFX 50E-RE, CIFX 50E-RE\ET .....	58
5.1.2	CIFX 50E-CCIES .....	60
5.1.3	CIFX 50-DP, CIFX 50E-DP .....	62
5.1.4	CIFX 50-2DP, CIFX 50E-2DP .....	64
5.1.5	CIFX 50-2DP\CO, CIFX 50E-2DP\CO .....	66
5.1.6	CIFX 50-2DP\DN, CIFX 50E-2DP\DN .....	68
5.1.7	CIFX 50-CO, CIFX 50E-CO .....	70
5.1.8	CIFX 50-2CO, CIFX 50E-2CO .....	72
5.1.9	CIFX 50-2CO\DN, CIFX 50E-2 CO\DN .....	74
5.1.10	CIFX 50-DN, CIFX 50E-DN .....	76
5.1.11	CIFX 50-2DN, CIFX 50E-2DN .....	78
5.1.12	CIFX 50-2ASM, CIFX 50E-2ASM .....	80
5.1.13	CIFX 50-CC, CIFX 50E-CC .....	82
5.1.14	Meaning of the Front Panel Inscriptions for 2 Channel Devices .....	83
5.2	PC Cards cifX Low Profile PCI Express .....	84
5.2.1	CIFX 70E-RE, CIFX 70E-RE\MR .....	84
5.2.2	CIFX 70E-CCIES .....	86
5.2.3	CIFX 100EH-RE\CUBE .....	88
5.2.4	CIFX 70E-DP, CIFX 70E-DP\MR .....	89
5.2.5	CIFX 70E-CO, CIFX 70E-CO\MR .....	91

5.2.6	CIFX 70E-DN, CIFX 70E-DN\MR .....	93
<b>6</b>	<b>HARDWARE INSTALLATION AND UNINSTALLING .....</b>	<b>95</b>
6.1	Fix Front Plate Sticker .....	96
6.1.1	Front Plate Sticker CIFX 50-RE, CIFX 50E-RE, CIFX 50E-RE\ET .....	96
6.1.2	Front Plate Sticker CIFX 70E-RE, CIFX 70E-RE\MR, CIFX 100EH-RE\CUBE .....	97
6.2	Installing PC Card cifX PCI, PCIe, Low Profile PCIe .....	99
6.3	Uninstalling the PC Card cifX PCI, PCIe, Low Profile PCIe .....	100
<b>7</b>	<b>TROUBLESHOOTING .....</b>	<b>101</b>
7.1	Instructions for Problem Solving .....	101
<b>8</b>	<b>LED DESCRIPTIONS .....</b>	<b>102</b>
8.1	Overview LEDs Real-Time Ethernet Systems .....	102
8.2	Overview LEDs Fieldbus Systems .....	103
8.3	System LED .....	104
8.4	CC-Link IE Field Basic Slave .....	105
8.5	CC-Link IE Field Slave .....	106
8.6	EtherCAT Master V3 .....	107
8.7	EtherCAT Master V4 .....	108
8.8	EtherCAT Slave .....	110
8.9	EtherNet/IP Scanner (Master) .....	111
8.10	EtherNet/IP Adapter (Slave) .....	113
8.11	Open Modbus/TCP .....	115
8.12	POWERLINK Controlled Node/Slave V2, V3 .....	116
8.13	PROFINET IO-Controller V2 .....	117
8.14	PROFINET IO Controller V3 .....	118
8.15	PROFINET IO-Device .....	120
8.16	Sercos Master .....	121
8.17	Sercos Slave .....	123
8.18	VARAN Client (Slave) .....	125
8.19	PROFIBUS DP Master .....	126
8.20	PROFIBUS DP Slave .....	127
8.21	PROFIBUS MPI Device .....	128
8.22	CANopen Master .....	129
8.23	CANopen Slave .....	130
8.24	DeviceNet Master .....	131
8.25	DeviceNet Slave .....	132
8.26	AS Interface Master .....	133
8.27	CC-Link Slave .....	134

<b>9</b>	<b>DEVICE CONNECTIONS AND SWITCHES .....</b>	<b>135</b>
9.1	Ethernet Interface.....	135
9.1.1	Ethernet Pin Assignment at the RJ45 Socket .....	135
9.1.2	Ethernet Connection Data .....	137
9.1.3	Use of Hubs and Switches .....	137
9.2	PROFIBUS Interface .....	138
9.3	CANopen Interface.....	138
9.4	DeviceNet Interface.....	139
9.5	AS-Interface Interface .....	139
9.6	CC-Link Interface .....	140
9.7	Rotary Switch for Slot Number (Card ID).....	141
9.7.1	Set Slot Number (Card ID) .....	141
9.7.2	Note for Device Exchange Service (Replacement Case): .....	141
9.7.3	Rotary Switch Slot Number PC Cards cifX Low Profile.....	142
9.8	SYNC Connector (Pin-Assignment, Hardware/Firmware).....	143
9.8.1	Pin Assignment SYNC Connector, X51 (CIFX 50 50E 70E).....	143
9.8.2	Pin Assignment SYNC Connector, J1 (CIFX 100EH) .....	143
9.8.3	Items on Hardware .....	144
9.8.4	Items on Firmware.....	144
9.9	Pin Assignment at the PCI Bus .....	145
9.9.1	Overview.....	145
9.9.2	References PCI Specifications.....	145
9.9.3	Pin Assignment for PCI Express Bus CIFX 100EH-RE\CUBE .....	146
<b>10</b>	<b>TECHNICAL DATA .....</b>	<b>147</b>
10.1	Technical Data PC Cards cifX.....	147
10.1.1	CIFX 50-RE .....	147
10.1.2	CIFX 50E-RE, CIFX 50E-RE\ET .....	149
10.1.3	CIFX 50E-CCIES, CIFX 70E-CCIES.....	151
10.1.4	CIFX 50-DP .....	153
10.1.5	CIFX 50E-DP .....	154
10.1.6	CIFX 50-CO.....	156
10.1.7	CIFX 50E-CO .....	157
10.1.8	CIFX 50-DN .....	158
10.1.9	CIFX 50E-DN.....	160
10.1.10	CIFX 50-CC .....	161
10.1.11	CIFX 50E-CC.....	162
10.1.12	CIFX 50-2DP .....	164
10.1.13	CIFX 50E-2DP.....	165
10.1.14	CIFX 50-2DP\CO.....	168
10.1.15	CIFX 50E-2DP\CO .....	169
10.1.16	CIFX 50-2DP\DN .....	171
10.1.17	CIFX 50E-2DP\DN.....	172
10.1.18	CIFX 50-2CO .....	174
10.1.19	CIFX 50E-2CO .....	175
10.1.20	CIFX 50-2CO\DN.....	177
10.1.21	CIFX 50E-2CO\DN .....	178

10.1.22	CIFX 50-2DN .....	180
10.1.23	CIFX 50E-2DN.....	181
10.1.24	CIFX 50-2ASM .....	183
10.1.25	CIFX 50E-2ASM .....	184
10.1.26	CIFX 70E-RE, CIFX 70E-RE\MR .....	185
10.1.27	CIFX 100EH-RE\CUBE .....	188
10.1.28	CIFX 70E-DP, CIFX 70E-DP\MR .....	190
10.1.29	CIFX 70E-CO, CIFX 70E-COMR .....	191
10.1.30	CIFX 70E-DN, CIFX 70E-DN\MR .....	193
10.2	PCI IDs PC Cards cifX on the PCI Bus.....	195
10.3	Supported PCI-Bus Commands .....	195
10.4	Technical Data of the Communication Protocols .....	196
10.4.1	CC-Link IE Field Basic Slave .....	196
10.4.2	CC-Link IE Field Slave .....	196
10.4.3	EtherCAT Master (V3).....	197
10.4.4	EtherCAT Master (V4).....	198
10.4.5	EtherCAT Slave.....	199
10.4.6	EtherNet/IP Scanner (Master) .....	200
10.4.7	EtherNet/IP Adapter (Slave).....	201
10.4.8	Open Modbus/TCP .....	202
10.4.9	POWERLINK Controlled Node/Slave (V2).....	203
10.4.10	POWERLINK Controlled Node/Slave (V3).....	203
10.4.11	PROFINET IO-Controller (V2) .....	204
10.4.12	PROFINET IO-Controller (V3) .....	205
10.4.13	PROFINET IO-Device (V3.4) .....	206
10.4.14	PROFINET IO Device (V3.13).....	207
10.4.15	Sercos Master .....	208
10.4.16	Sercos Slave .....	209
10.4.17	VARAN Client (Slave).....	210
10.4.18	PROFIBUS DP Master .....	211
10.4.19	PROFIBUS DP Slave .....	212
10.4.20	PROFIBUS MPI.....	213
10.4.21	CANopen Master .....	214
10.4.22	CANopen Slave .....	215
10.4.23	DeviceNet Master .....	216
10.4.24	DeviceNet Slave .....	217
10.4.25	AS-Interface Master.....	218
10.4.26	CC Link Slave.....	219
11	ANNEX.....	220
11.1	Device Label with Matrix Code .....	220
11.2	Tolerances of the shown Card Dimensions .....	220
11.3	Dimensions PC Cards cifX PCI and PCI Express.....	221
11.3.1	CIFX 50-RE .....	221
11.3.2	CIFX 50E-RE, CIFX 50E-RE\ET .....	222
11.3.3	Front Panel CIFX 50-RE, CIFX 50E-RE or CIFX 50E-RE\ET .....	223
11.3.4	CIFX 50E-CCIES.....	224
11.3.5	Front Panel CIFX 50-CCIES .....	225

11.3.6	CIFX 50-DP, CIFX 50E-DP .....	226
11.3.7	Front Panel CIFX 50-DP or CIFX 50E-DP .....	228
11.3.8	CIFX 50-CO, CIFX 50E-CO .....	229
11.3.9	Front Panel CIFX 50-CO or CIFX 50E-CO.....	231
11.3.10	CIFX 50-DN, CIFX 50E-DN.....	232
11.3.11	Front Panel CIFX 50-DN or CIFX 50E-DN.....	234
11.3.12	CIFX 50-CC, CIFX 50E-CC.....	235
11.3.13	Front Panel CIFX 50-CC or CIFX 50E-CC.....	237
11.3.14	CIFX 50-2DP .....	238
11.3.15	CIFX 50E-2DP.....	239
11.3.16	CIFX 50-2DP\CO.....	240
11.3.17	CIFX 50E-2DP\CO .....	241
11.3.18	CIFX 50-2DP\DN.....	242
11.3.19	CIFX 50E-2DP\DN.....	243
11.3.20	CIFX 50-2CO .....	244
11.3.21	CIFX 50E-2CO .....	245
11.3.22	CIFX 50-2CO\DN.....	246
11.3.23	CIFX 50E-2CO\DN .....	247
11.3.24	CIFX 50-2DN .....	248
11.3.25	CIFX 50E-2DN.....	249
11.3.26	Front Panel CIFX 50-2FB.....	250
11.3.27	CIFX 50-2ASM, CIFX 50E-2ASM.....	251
11.3.28	Front Panel CIFX 50-2ASM, CIFX 50E-2ASM.....	253
11.4	Dimensions PC Cards cifX Low Profile PCI Express .....	254
11.4.1	CIFX 70E-RE, CIFX 70E-RE\MR .....	254
11.4.2	Front Panel CIFX 70E-RE, CIFX 70E-RE\MR .....	255
11.4.3	CIFX 70E-CCIES.....	256
11.4.4	Front Panel CIFX 70-CCIES .....	257
11.4.5	CIFX 70E-DP, CIFX 70E-DP\MR .....	258
11.4.6	CIFX 70E-CO, CIFX 70E-CO\MR .....	260
11.4.7	Front Panel CIFX 70E-CO, CIFX 70E-CO\MR.....	261
11.4.8	CIFX 70E-DN, CIFX 70E-DN\MR.....	262
11.4.9	Front Panel CIFX 70E-DN, CIFX 70E-DN\MR .....	263
11.5	Notes on earlier Hardware Revisions .....	264
11.5.1	Failure in 10 MBit/s Half Duplex Mode and Workaround .....	264
11.6	Disposal of Waste Electronic Equipment.....	265
11.7	References.....	265
11.8	EtherCAT Summary over Vendor ID, Conformance test, Membership and Network Logo.....	266
11.8.1	Vendor ID .....	266
11.8.2	Conformance .....	266
11.8.3	Certified Product vs. Certified Network Interface .....	266
11.8.4	Membership and Network Logo .....	267
11.9	List of Figures .....	268
11.10	List of Tables.....	270
11.11	Glossary.....	274
11.12	Contacts.....	284

# 1 Introduction

## 1.1 About the User Manual

This user manual provides descriptions of the **installation, operation and hardware** of the PC Cards cifX *PCI, PCI Express* and *Low Profile PCI Express* under Windows® XP, Windows® Vista, Windows® 7 and Windows® 8, as listed subsequently.

PC Cards cifX:

- PCI (CIFX 50),
- PCI Express (CIFX 50E),
- Low Profile PCI Express (CIFX 70E, CIFX 100EH-RE\CUBE\*)

*\*only Real-Time Ethernet*

for the Real-Time Ethernet systems:

- CC-Link IE Field
- CC-Link IE Field Basic
- EtherCAT
- EtherNet/IP
- Open-Modbus/TCP
- POWERLINK
- PROFINET IO
- Sercos
- VARAN

for the fieldbus systems:

- PROFIBUS DP
- PROFIBUS MPI
- CANopen
- DeviceNet
- AS-Interface
- CC-Link



For information about the **Installation of the Software** refer to the User Manual „Software Installation for PC Cards cifX“ [DOC120207UMXXEN]. For information about the **Wiring of the Protocol Interface** refer to the „Wiring Instructions“ [DOC120208UMXXEN].

The **devices described in this manual** are listed in the sections

- *PC Cards PCI CIFX 50-XX* (page 36),
- *PC Cards PCI (2 Channels) CIFX 50-2XX, CIFX 50-2XX1XX* (page 37) and
- *PC Cards PCI Express CIFX 50E-XX, CIFX 70E-XX, CIFX 100EH-RE\CUBE* (page 37). The devices are described in detail in the chapters *Hardware Installation and Uninstalling* (page 95), *LED Descriptions* (page 102), *Device Connections and Switches* (page 135) and *Technical Data* (page 147).

You can download the latest edition of a manual from the website [www.hilscher.com](http://www.hilscher.com) under **Support > Downloads > Manuals** or under **Products** directly with the information about your product.



## 1.1.1 List of Revisions

Index	Date	Chapter	Revisions
49	17-11-28	All	CC-Link IE Field Slave devices added: - CIFX 50E-CCIES, - CIFX 70E-CCIES
		9.1.1	Section <i>Ethernet Pin Assignment at the RJ45 Socket</i> . Ethernet RJ45 pin assignment (1000 MBit/s) added.
	18-03-21	All, 2, 4.1, 10.1, 10.1.3	Storage temperature range updated: -40 °C ... +85 °C Safety communication in the document revised. Chapter <i>Safety</i> completed. Section <i>Warnings</i> moved and changed. Section <i>Technical Data PC Cards cifX</i> : Description "Maximum current at 3.3 V (typical) [value]" changed to "Current at 3.3 V [value] (maximum)". Section <i>CIFX 50E-CCIES, CIFX 70E-CCIES</i> updated (current at 3.3V typically, ranges for operating and storage temperature).
50	18-08-15	All  8.1, 8.9, 8.10	CC-Link IE Field Basic Slave added, CIFX 50-RE\ET removed, CIFX 50-RE (Revision 6, operating temperature up to + 70°C) added. Newly added: CIFX 50E-2DP, CIFX 50E-2CO, CIFX 50E-2DN, CIFX 50E-2DPCO, CIFX 50E-2DPDN, CIFX 50E-2CODN Section <i>Overview LEDs Real-Time Ethernet Systems</i> note added. Sections <i>EtherNet/IP Scanner (Master)</i> and <i>EtherNet/IP Adapter (Slave)</i> updated.
51	18-12-06	1.2.3  1.2.4, 4.4, 8.4 10.1, 10.4	<b>Section: Important Changes</b> PROFINET IO Controller Firmware Versions V2 and V3 Update to: PROFINET IO Controller V3 Protocol API 07 EN.pdf PROFINET IO-Device Firmware Versions 3.4 and 3.13 V3.10 --> V3.13 Migration Guide PROFINET IO Device, Migration from V3.x to V3.13 GSDML-V2.32 --> GSDML-V2.33 DVD path 3.10 --> 3.13 Update to: PROFINET IO-Device V3.13 Protocol API 18 EN.pdf EtherCAT Slave Firmware Versions 2.5 and 4.7 Update to: EtherCAT Slave V4 Protocol API 10 EN.pdf EtherCAT Slave Firmware Version 4.7 POWERLINK Controlled Node V2 and V3 Update to: POWERLINK Controlled Node Protocol V3 API 08 EN.pdf <b>Section Device Description Files PC Cards cifX</b> : Name of the device description file for CC-Link IE Field Basic Slave added (0x0352_CIFX RE CCIEBS_1_en.cspp). <b>Section Notes for the Configuration of the Master Device</b> : Note for CC-Link IE Field-Basic-Slave completed. <b>Section CC-Link IE Field Basic Slave</b> updated. <b>Section Technical Data PC Cards cifX</b> : Information on UL certification reviewed and revised according to UL Report File E221530 (Vol. 2, Issued: 2009-12-22). <b>Section Technical Data of the Communication Protocols</b> updated (EtherCAT Slave\4.7, EtherNetIP Scanner\2.10, EtherNetIP Adapter\2.13, POWERLINK Controlled Node V3.4, PROFINET IO Controller V3.3, PROFINET IO RT IRT Device V3.13, PROFIBUS-DP Master\2.8, \PROFIBUS-DP Slave\2.10, Sercos Slave V3.5, VARAN Client\1.1, CC-Link Slave\2.12)
52	19-03-06	4.5	<b>Section Device Names in SYCON.net</b> device name updated: CC-Link IE Field Basic Slave: CiFX RE/CCIBS Terminology: "current" changed to "current consumption" where this meaning is meant.
53	19-08-29	1.1.2.1, 9.9.1  1.1.2.3	Sections <b>Hardware: PC Cards cifX</b> and <b>Overview: Hardware</b> revisions updated for CIFX 50-DP (Revision 6), CIFX 50-CO (Revision 6), CIFX 50-DN (Revision 6), CIFX 50E-RE (Revision 6) , CIFX 50E-RE\ET (Revision 2). <b>Section Firmware</b> : Firmware name updated: POWERLINK Controlled Node V3.4: C010K000.NXF, PROFINET IO-Device V3.13: C010D000.NXF

Table 1: List of Revisions

## 1.1.2 Notes on Hardware, Firmware, Software and Driver Versions



**Note on Software Update:** The hardware revisions and the versions for the firmware, the driver or the configuration software listed in this section functionally belong together. For existing hardware installation the firmware, the driver and the configuration software must be updated according to the details listed in this section.

For the software upgrade system overview refer to section *Update for Firmware, Driver and Software* on page 57.

### 1.1.2.1 Hardware: PC Cards cifX

PC Card cifX	Part No.	Hardware Revision	USB from HW Rev.	„Rotary Switch Slot Number (Card ID)“ from HW Rev.	„DMA Mode“ from HW Rev.
CIFX 50-RE	1250.100	6	-	3	1
CIFX 50-DP	1250.410	6	-	5	1
CIFX 50-CO	1250.500	6	-	5	1
CIFX 50-DN	1250.510	6	-	5	1
CIFX 50-CC	1250.740	2	-	2	1
CIFX 50E-RE	1251.100	6	-	4	4
CIFX 50E-RE\ET	1251.105	2	-	1	1
CIFX 50E-CC\IES	1251.700	1	-	1	1
CIFX 50E-DP	1251.410	6	-	5	5
CIFX 50E-CO	1251.500	5	-	4	4
CIFX 50E-DN	1251.510	5	-	4	4
CIFX 50E-CC	1251.740	4	-	3	3
CIFX 50-2DP	1252.410	3	-	3	1
CIFX 50-2DP\CO	1252.470	2	-	2	1
CIFX 50-2DP\DN	1252.480	1	-	1	1
CIFX 50-2CO	1252.500	2	-	2	1
CIFX 50-2CO\DN	1252.570	1	-	1	1
CIFX 50-2DN	1252.510	2	-	2	1
CIFX 50-2ASM	1252.630	2	-	2	1
CIFX 50E-2DP	1.253.410	1	-	1	1
CIFX 50E-2DP\CO	1.253.470	1	-	1	1
CIFX 50E-2DP\DN	1.253.480	1	-	1	1
CIFX 50E-2CO	1.253.500	1	-	1	1
CIFX 50E-2CO\DN	1.253.570	1	-	1	1
CIFX 50E-2DN	1.253.510	1	-	1	1
CIFX 50E-2ASM	1253.630	5	-	2	4
CIFX 70E-RE	1.259.100	1	-	1	1
CIFX 70E-RE\MR	1.259.103	1	-	1	1
CIFX 70E-CC\IES	1259.700	1	-	1	1
CIFX 100EH-RE\CUBE	9016.090	4	-	1	1
CIFX 70E-DP	1.259.410	1	-	1	1
CIFX 70E-DP\MR	1.259.413	1	-	1	1
CIFX 70E-CO	1.259.500	1	-	1	1
CIFX 70E-CO\MR	1.259.503	1	-	1	1
CIFX 70E-DN	1.259.510	1	-	1	1

PC Card cifX	Part No.	Hardware Revision	USB from HW Rev.	„Rotary Switch Slot Number (Card ID)“ from HW Rev.	„DMA Mode“ from HW Rev.
CIFX 70E-DNMR	1.259.513	1	-	1	1

Table 2: Reference on Hardware PC Cards cifX

### 1.1.2.2 Driver and Software

Driver and Software	Version
SYCON.net	SYCONnet netX setup.exe 1.0500
netX Configuration Tool-Setup	netXConfigurationUtility_Setup.exe 1.0900
cifX Device Driver	cifX Device Driver Setup.exe 1.6
Toolkit	1.5
cifX TCP/IP Server for SYCON.net	cifX TCP Server.exe V2.3
US Driver	USB Driver of Windows® 5.1.2600.x

Table 3: Reference on Driver and Software

### 1.1.2.3 Firmware

The downloadable cifX firmware runs on PC Cards cifX *PCI*, *PCI Express* and *Low Profile PCI Express* (unless otherwise stated). The firmware automatically detects whether it is running on a PC Cards cifX *PCI*, *PCI Express* or *Low Profile PCI Express*.

#### **PC Cards and PCI Express with one Channel:**

Protocol	Firmware File	Firmware Version*	Minimum Version of the Firmware for USB Support
CANopen Master	CIFXCOM.NXF	2.14	from 2.5.2.0
CANopen Slave	CIFXCOS.NXF	3.7	from 2.4.4.0
CC-Link Slave	CIFXCCS.NXF	2.12	-
CC-Link IE Field Basic Slave	C020Y000.NXF	1.1	-
CC-Link IE Field Slave***	C020X000.NXF	1.1	-
DeviceNet Master	CIFXDNM.NXF	2.4	from 2.2.7.0
DeviceNet Slave	CIFXDNS.NXF	2.5	from 2.2.7.0
EtherCAT Master	CIFXECM.NXF	4.4 (V4)	from 2.4.4.0
EtherCAT Master	CIFXECM.NXF	3.0 (V3)**	from 2.4.4.0
EtherCAT Slave	CIFXECS.NXF	4.7 (V4)	from 2.5.13.0
EtherCAT Slave	CIFXECS.NXF	2.5 (V2)**	from 2.5.13.0
EtherNet/IP Scanner	CIFXEIM.NXF	2.10	from 2.2.4.1
EtherNet/IP Adapter	CIFXEIS.NXF	2.13	from 2.3.4.1
Open-Modbus/TCP	CIFXOMB.NXF	2.6	from 2.3.2.1
POWERLINK Controlled Node	C010K000.NXF	3.4 (V3)	from 2.1.22.0
POWERLINK Controlled Node	CIFXPLS.NXF	2.1 (V2)**	from 2.1.22.0
PROFIBUS DP Master	CIFXDPM.NXF	2.8	from 2.3.22.0
PROFIBUS DP Slave	CIFXDPS.NXF	2.10	from 2.3.30.0
PROFIBUS MPI-Gerät	CIFXMPI.NXF	2.4	from 2.4.1.2
PROFINET IO-Controller	C010C000.NXF	3.3 (V3)	from 2.4.10.0
PROFINET IO-Controller	CIFXPNM.NXF	2.7 (V2)**	from 2.4.10.0
PROFINET IO-Device	C010D000.NXF	3.13 (V3)	from 3.4.9.0

Protocol	Firmware File	Firmware Version*	Minimum Version of the Firmware for USB Support
PROFINET IO-Device	CIFXPNS.NXF	3.4 (V3)**	from 3.4.9.0
Sercos Master	CIFXS3M.NXF	2.1	from 2.0.14.0
Sercos Slave	CIFXS3S.NXF	3.5	from 3.0.13.0
VARAN-Client	CIFXVRS.NXF	1.1	from 1.0.3.0

Table 4: Reference on Firmware (for 1 Channel Systems), \*\*Outdated versions



**Note:** \*Unless otherwise indicated, in this manual data to the firmware version correspond to the stack version.



**\*\*\*Important!** Use the PC cards CIFX 50E-CCIES or CIFX 70E-CCIES only together with the CC-Link IE Field Slave firmware and do not use this firmware for any other cards.

### PC Cards PCI and PCI Express with two Channels:

Protocol Channel X1	Stack-Version	Protocol Channel X2	Stack-Version	Firmware File	Firmware Version
AS-Interface Master	2.4	AS-Interface Master	2.4	CIFX2ASM.NXF	2.4
CANopen Master	2.14	CANopen Master	2.14	C0204040.NXF	1.2
CANopen Master	2.14	CANopen Slave	3.7	C0204050.NXF	1.2
CANopen Master	2.14	DeviceNet Master	2.4	C0204060.NXF	1.2
CANopen Slave	3.7	CANopen Slave	3.7	C0205050.NXF	1.2
CANopen Slave	3.7	DeviceNet Slave	2.5	C0205070.NXF	1.2
DeviceNet Master	2.4	DeviceNet Master	2.4	C0206060.NXF	1.2
DeviceNet Master	2.4	DeviceNet Slave	2.5	C0206070.NXF	1.2
DeviceNet Slave	2.5	DeviceNet Slave	2.5	C0207070.NXF	1.2
PROFIBUS DP Master	2.7	PROFIBUS DP-Master	2.7	CIFX2DPM.NXF	1.2 (new version counting)
PROFIBUS DP Master	2.7	PROFIBUS DP-Slave	2.9	C0201020.NXF	1.2
PROFIBUS DP Master	2.7	CANopen Master	2.14	C0201040.NXF	1.2
PROFIBUS DP Master	2.7	DeviceNet Master	2.4	C0201060.NXF	1.2
PROFIBUS DP Slave	2.9	PROFIBUS DP-Slave	2.9	CIFX2DPS.NXF	1.1 (new version counting)
PROFIBUS DP Slave	2.9	CANopen Slave	3.7	C0202050.NXF	1.2
PROFIBUS DP Slave	2.9	DeviceNet Slave	2.5	C0202070.NXF	1.2

Table 5: Reference on Firmware (for 2 Channel Systems)

### 1.1.3 Conventions in this Manual

Notes, operation instructions and results of operation steps are marked as follows:

#### Notes



**Important:** <important note you must follow to avoid malfunction>



**Note:** <general note>



<note, where to find further information>

#### Operation Instructions

1. <instruction>
2. <instruction>

or

- <instruction>

#### Results

↪ <result>

#### Safety Messages

The labeling of safety messages is explained in the chapter *Safety*.

### 1.1.4 Used Terminology

<b>PC Card cifX</b>	Communication Interfaces of the cifX family of Hilscher based on the netX technology.
<b>CIFX 50-RE</b>	Example for the product name for a PC card cifX Real-Time Ethernet.
<b>CIFX 50-XX</b>	Example ('XX' replaces 'RE', 'DP', 'CO', 'DN' or 'CC')



For further terminology to the PC cards cifX, its installation, configuration and operation refer to glossary in the annex.

## 1.2 Contents of the Product DVD



---

**Note!** In order to download the product DVD, you need Internet access.

---

On the **Communication Solutions DVD** you will find these installation instructions about the software installation and the necessary configuration software, the documentation, the drivers and software for your PC Card cifX, and additional auxiliary tools. You can download this product DVD as a ZIP file from the website <http://www.hilscher.com> (under Products, directly with the information on your product).

### 1.2.1 Installation Guide, Documentation Overview



---

The installation guide **Software Installation and Documentation Overview** on the Communication Solutions DVD are in the directory *Documentation\0. Installation and Overview*. The installation guide includes:

- An overview on the **Content of the Communication Solutions DVD** (in the section *What is on the Communication Solutions DVD?*)
  - Overviews listing the available **Documentations** for PC cards cifX (in chapter *PC Cards cifX, Software and Documentation*).
- 

### 1.2.2 What's New



---

All current version information for hardware and software described in this manual are provided in the folder *\Documentation\What's New - Communication Solutions DVD RL XX EN.pdf* on the Communication Solutions DVD.

---

### 1.2.3 Important Changes

#### 1.2.3.1 DeviceNet Master - SYCON.net and Firmware

The DeviceNet Master firmware from V2.3.11.0 and the DeviceNet Master DTM from V1.360.x.x support the network scan function. If in the device a firmware version V2.3.10.0 or earlier is used then a firmware update to V2.3.11.0 or higher must be done, in order to use the **network scan** function.

### 1.2.3.2 PROFINET IO-Controller Firmware Versions V2 and V3

The PROFINET IO-Controller firmware has been revised and completed and is available in version V3 since the first quarter of 2017.

Upgrading the PROFINET IO-Controller firmware from V2 to V3 is recommended. Use the PROFINET IO-Controller firmware V3 for a new installation when creating or developing your application program for the first time.

The development of the PROFINET IO-Controller firmware V2 will not be continued. But this firmware version is still maintained and will be delivered furthermore.

The PROFINET IO-Controller V3 implements several new features, which are not available in the PROFINET IO-Controller V2:

- IRT operating mode
- Optimized process data performance
- Automatic name assignment
- Automatic alarm acknowledgement
- MRP Client and Manager for media redundancy
- Requirements PROFINET Specification 2.3: e. g. Advanced Startup, MultipleInterfaceMode, network load requirements.

The process data handling in PROFINET IO-Controller V3 (process data image structure and process data timing) was reworked to achieve the required performance improvement and to support synchronized applications.

Removed features and incompatibilities:

- PROFINET IO-Controller V3 does neither support swapping of IO data nor automatic IOPS handling.
- The configuration parameters have been extended to meet the IRT configuration requirements. The structure of the configuration database has been changed. Therefore, the PROFINET IO-Controller V3 can not be configured with a configuration database of the PROFINET IO-Controller V2 and vice versa.
- The configuration API of PROFINET IO-Controller V2 are not supported by PROFINET IO-Controller V3. The new configuration API of PROFINET IO-Controller V3 is to be used.
- The PROFINET IO-Controller V3 does not support process data in little endian format. This feature was rarely used and has been removed for better performance.

If you want to change in an existing system from the PROFINET IO-Controller firmware V2 to V3, note the following guidelines:

1. Customize your application program according to the Migration Guide **PROFINET IO Controller Migrating from version 2 to 3**.



If you want to change to V4.2, please check in the Migration Guide **PROFINET IO Controller Migrating from version 2 to 3** which changes are necessary in the application program in order to use version 4.2.

2. If you upgrade to the PROFINET IO-Controller firmware V3, you can not reuse the existing SYCON.net project of the PROFINET IO-Controller firmware V2. Create a new configuration. For the PROFINET IO-Controller firmware V3 for configuration, you need SYCON.net from version 1.400, which contains new configuration dialogs (PROFINET IO IRT-Controller DTM).
3. Update the PROFINET IO controller firmware in your device to Version 3.

On the Communication Solutions DVD, files and manuals referring to firmware V2 and V3, are available as follows:

	<b>PROFINET IO-Controller V2</b> Directory on the DVD \ File:	<b>PROFINET IO-Controller V3</b> Directory on the DVD \ File:
<b>Firmware</b>	<i>Firmware\CIFX\Outdated versions\PNM V2\ cifxpnm.nxf</i>	<i>Firmware\CIFX\C010C000.nxf</i>
<b>Header</b>	<i>Examples and API\0. Header\Firmware\PROFINET IO Controller V2</i>	<i>Examples and API\0. Header\Firmware\PROFINET Controller V3</i>
<b>Protocol API</b>	<i>Documentation\7. Programming Manuals\EN\3. Protocol API\PROFINET IO Controller\ PROFINET IO Controller Protocol API 19 EN.pdf, Ethernet Protocol API.pdf, TCP IP - Packet Interface API 12 EN.pdf</i>	<i>Documentation\7. Programming Manuals\EN\3. Protocol API\PROFINET IO Controller V3\ PROFINET IO Controller V3 Protocol API 07 EN.pdf PROFINET IO Controller - Migrating from version 2 to 3 MG 01 EN.pdf</i>

Table 6: PROFINET IO-Controller Firmware V2 and V3 on the Product DVD



### 1.2.3.3 PROFINET IO-Device Firmware Versions V3.4 and V3.13

The PROFINET IO Device firmware was revised and completed and is available in version 3.13 since the fourth quarter 2018.

Use the PROFINET IO Device firmware in version 3.13 for a new installation, when you create or develop your application program for the first time.

If you want to change in an existing system from the PROFINET IO Device firmware version 3.4 to the version 3.13, note the following guidelines:

1. Customize your application program according to the Migration Guide **PROFINET IO Device, Migration from V3.x to V3.13**.



If you want to change to V3.13, please check in the Migration Guide **PROFINET IO Device, Migration from V3.x to V3.13** which changes are necessary in the application program in order to use version 3.13.

2. Adjust the configuration of your PROFINET IO Controller device. Use the new GSDML file in the configuration software of the PROFINET IO Controller for this:  
*GSDML-V2.33-HILSCHER-CIFX RE PNS-xxxxxxx.xml*.
3. Update the PROFINET IO Device firmware in your device to version 3.13.

Note also:

- SYCON.net V1.500.x.x can configure the PROFINET IO Device firmware V3.4 as well as V3.13
- The development of the PROFINET IO Device firmware V3.4 will not be continued, but this firmware version will be delivered furthermore.

On the Communication Solutions DVD, software and manuals relating to both firmware versions V3.4 and V3.13 are available:

	<b>PROFINET IO-Device V3.4</b> Directory on the DVD \ File:	<b>PROFINET IO-Device V3.13</b> Directory on the DVD \ File:
<b>Firmware</b>	<i>Firmware\CIFX\cifxpns.nxf</i>	<i>Firmware\CIFX\C010D000.nxf</i>
<b>Header</b>	<i>Examples and API\0. Header\Firmware\PROFINET IO Device V3.4.X</i>	<i>Examples and API\0. Header\Firmware\PROFINET IO Device V3.13</i>
<b>GSDML</b>	<i>EDS\PROFINET\3.4.X\GSDML-V2.33-HILSCHER-CIFX RE PNS-20130225.xml</i>	<i>EDS\PROFINET\Device\3.13\GSDML-V2.33-HILSCHER-CIFX RE PNS-xxxxxxx.xml</i>
<b>Protocol API</b>	<i>Documentation\7. Programming Manuals\EN\3. Protocol API\PROFINET IO Device V3.4\PROFINET IO Device Protocol API 13 EN.pdf</i> <i>TCP IP - Packet Interface API 13 EN.pdf</i>	<i>Documentation\7. Programming Manuals\EN\3. Protocol API\PROFINET IO Device V3.13\PROFINET IO Device V3.13 Protocol API 18 EN.pdf</i> <i>PROFINET IO Device - Migration from Version 3.x to 3.13 MG 09 EN.pdf</i>

Table 7: PROFINET IO-Device Firmware Version 3.4 and 3.13, Header, GSDML and Protocol API Manual

### 1.2.3.4 EtherCAT Master Firmware Versions V3 and V4

The EtherCAT Master firmware has been revised and completed and is available in version V4 since the first quarter of 2017.

Upgrading the EtherCAT Master firmware from V3 to V4 is recommended. Use the EtherCAT Master firmware V4 for a new installation when creating or developing your application program for the first time, as well as in existing systems.

The reasons for upgrading are as follows:

- The development of the EtherCAT Master firmware V3 will not be continued. But this firmware version will be delivered furthermore.
- Due to the software design, the EtherCAT Master firmware V3 has considerable performance limitations on Hilscher products.
- Compared to the EtherCAT Master firmware V3, the EtherCAT Master firmware V4 has major improvements, while keeping the backward compatibility to the firmware V3 as much as possible. Due to the improvements, there are advantages in device certification.

Performance improvement and new functions with EtherCAT Master firmware V4:

- General performance improvement up to five times
- Improvements in network and individual Slave control, Slave diagnostics
- Support of CoE, SoE, EoE, FoE, ExtSync
- Support of redundancy in different, even complex topologies, including DC and DC resynchronization and hot-connect.
- Troubleshooting improvement.

If you want to change in an existing system from the EtherCAT Master firmware V3 to V4, you need to upgrade the EtherCAT Master firmware in your device to V4.

With SYCON.net, you can configure both the EtherCAT Master firmware V3 as well as the EtherCAT Master firmware V4. When you upgrade to the EtherCAT Master firmware V4, you can continue to use the existing SYCON.net project.

On the Communication Solutions DVD, files and manuals referring to firmware V3 and V4, are available as follows:

	<b>EtherCAT Master V3</b> Directory on the DVD \ File:	<b>EtherCAT Master V4</b> Directory on the DVD \ File:
<b>Firmware</b>	<i>Firmware\CIFX\Outdated versions\ECM V3\cifxecm.nxf</i>	<i>Firmware\CIFX\cifxecm.nxf</i>
<b>Header</b>	<i>Examples and API\0. Header\Firmware\EtherCAT Master V3</i>	<i>Examples and API\0. Header\Firmware\EtherCAT Master V4</i>
<b>Protocol API</b>	<i>Documentation\7. Programming Manuals\EN\3. Protocol API\EtherCAT Master V3\EtherCAT Master V3 Protocol API 05 EN.pdf</i>	<i>Documentation\7. Programming Manuals\EN\3. Protocol API\EtherCAT Master V4\EtherCAT Master V4 Protocol API 05 EN.pdf</i>

Table 8: EtherCAT Master Firmware V3 and V4 on the Product DVD

### 1.2.3.5 EtherCAT Slave Firmware Versions V2.5 and V4.7

The EtherCAT Slave firmware was revised and completed and is available in version 4.7.

Use the EtherCAT Slave firmware in version 4.7 for a new installation, when you create or develop your application program for the first time.

If you want to change in an existing system from the EtherCAT Slave firmware version 2.5 to the version 4.7, note the following guidelines:

1. Customize your application program according to the Migration Guide **EtherCAT Slave, Migration from V2.5 to V4.2**.



If you want to change to V4.7, please check in the Migration Guide **EtherCAT Slave, Migration from V2.5 to V4.2** which changes are necessary in the application program in order to use version 4.7.

2. Adjust the configuration of your EtherCAT Master device. Use the new XML file in the configuration software of the EtherCAT Master for this: *Hilscher CIFS RE ECS V4.6.X.xml*.
3. Update the EtherCAT Slave firmware in your device to version 4.7.

Note also:

- SYCON.net V1.500 can configure the EtherCAT Slave firmware V2.5 as well as V4.7 and higher.
- The development of the EtherCAT Slave firmware V2.5 will not be continued, but this firmware version will be delivered furthermore.

On the Communication Solutions DVD, software and manuals relating to both firmware versions V2.5 and V4.7 are available:

	<b>EtherCAT-Slave V2.5</b> Directory on the DVD \ File:	<b>EtherCAT-Slave V4.7</b> Directory on the DVD \ File:
<b>Firmware</b>	<i>Firmware\CIFS\cifxecs.nxf</i>	<i>Firmware\CIFS\ECS V4.X\cifxecs.nxf</i>
<b>Header</b>	<i>Examples and API\0. Header\Firmware\EtherCAT Slave V2.5.X</i>	<i>Examples and API\0. Header\Firmware\EtherCAT Slave V4</i>
<b>XML</b>	<i>EDS\EtherCAT\Slave\V2.X\Hilscher CIFS RE ECS V2.2.X.xml</i>	<i>EDS\EtherCAT\Slave\V4\Hilscher CIFS RE ECS V4.6.X.xml</i>
<b>Protocol API</b>	<i>Documentation\7. Programming Manuals\EN\3. Protocol API\EtherCAT Slave V2\EtherCAT Slave Protocol API 21 EN.pdf</i>	<i>Documentation\7. Programming Manuals\EN\3. Protocol API\EtherCAT Slave V4\EtherCAT Slave V4 Protocol API 10 EN.pdf</i> <i>EtherCAT Slave - Migration from Version 2.5 to 4.2 MG 02 EN.pdf</i> <i>Object Dictionary V3 03 API EN.pdf</i>

Table 9: EtherCAT-Slave Firmware Version 2.5 and 4.7, Header, XML and Protocol API Manual

### 1.2.3.6 EtherCAT Slave Firmware Version V4.7

In the past, the application had to use several packets in order to set Station Alias Address. Now the EtherCAT Slave firmware executes the Station Alias Address handling. Starting with version 4.6, the firmware saves the Station Alias Address (Second Station Address) non volatile and afterwards the firmware sets it to the ESC register. As a result, the application does not have to handle the Station Alias Address anymore compared to earlier EtherCAT Slave firmware versions.

### 1.2.3.7 POWERLINK Controlled Node Firmware Versions V2 and V3

The POWERLINK Controlled Node firmware has been revised and completed and is available in version V3 since the third quarter of 2017.

Do not use the POWERLINK Controlled Node V2.x for new applications. For a new installation when creating or developing your application program for the first time, use the POWERLINK Controlled Node firmware V3. Already existing applications based on V2.x do not need to be upgraded.

The reasons for upgrading are as follows:

- The development of the POWERLINK Controlled Node firmware V2 will not be continued.
- Performance improvements
- IPV4 support according to EPSG specification
- Multiple ASnd

POWERLINK Controlled Node V3 is developed to fulfill the following requirements:

- Support of netX 100-based products.
- Optimization of the internal stack structure to improve performance and less memory space requirement.
- POWERLINK Controlled Node V3 uses the object dictionary V3 component, to achieve a common base with other Hilscher stacks.
- Applications, which used configuration database (*inibatch.nxd*) or configuration API of POWERLINK Controlled Node V2, can be easily migrated to V3 because these configuration mechanisms are supported also for V3.

If you want to change in an existing system from the POWERLINK Controlled Node firmware V2 to V3, note the following guidelines:

1. Using the same configuration project, SYCON.net V1.500 can configure the POWERLINK Controlled Node firmware V2 as well as V3.
2. If the application program uses the API for object dictionary V2, the application program must be adapted and the API for object dictionary V3 must be used. The API of the object dictionary was changed incompatible from V2 to V3 and may require additional effort if these services are used.
3. Adjust the configuration of your POWERLINK Managing Node device. Use the new updated XDD file in the configuration software of the POWERLINK Managing Node for this: *00000044\_CIFX RE PLS.xdd*.

- Update the POWERLINK Controlled Node firmware in your device to V3.



On the Communication Solutions DVD, files and manuals referring to firmware V2 and V3, are available as follows:

	<b>POWERLINK Controlled Node V2</b> Directory on the DVD \ File:	<b>POWERLINK Controlled Node V3</b> Directory on the DVD \ File:
<b>Firmware</b>	<i>Firmware\CIFX\Outdated versions\PLS V2\ cifxpls.nxf</i>	<i>Firmware\CIFX\ C010K000.nxf</i>
<b>Header</b>	<i>Examples and API\0. Header\Firmware\ POWERLINK Controlled Node V2\netX 100 based</i>	<i>Examples and API\0. Header\Firmware\ POWERLINK Controlled Node V3</i>
<b>XDD</b>	<i>EDS\POWERLINK\Slave\V2\ 00000044_CIFX RE PLS.xdd</i>	<i>EDS\POWERLINK\Slave\V3\ 00000044_CIFX RE PLS.xdd</i>
<b>Protocol API</b>	<i>Documentation\7. Programming Manuals\EN\ 3. Protocol API\POWERLINK Controlled Node V2\ Powerlink Controlled Node Protocol API 12 EN.pdf</i>	<i>Documentation\7. Programming Manuals\EN\ 3. Protocol API\POWERLINK Controlled Node V3\ POWERLINK Controlled Node V3 Protocol API 08 EN.pdf</i>

Table 10: POWERLINK Controlled Node Firmware V2 and V3 on the Product DVD

## 1.2.4 Device Description Files PC Cards cifX

The Communication Solutions DVD **EDS** directory includes the device description files for the PC Cards cifX. The device description file is required to configure the used Master device. The systems Open Modbus/TCP, AS-Interface, PROFIBUS MPI and VARAN do not use device description files.

<b>PC Cards cifX</b>	<b>System</b>	<b>File Name of the Device Description File</b>	
CIFX 50-RE, CIFX 50E-RE, CIFX 50E-RE\ET, CIFX 70E-RE, CIFX 70E-RE\MR, CIFX 100EH- RE\CUBE	CC-Link IE Field Basic Slave	0x0352_CIFX RE CCI EBS_1_en.csp	
	EtherCAT Slave	For the EtherCAT Slave Firmware V2.5: <i>Hilscher CIFX RE ECS V2.2.X.xml</i> (or with extension DDF)	
		For the EtherCAT Slave Firmware with V4.6 the <i>Hilscher CIFX RE ECS V4.6.X.xml</i> is provided.	
	 <b>Note!</b> If the XML file <i>Hilscher cifX RE ECS V2.2.x.xml</i> is used/re-installed, the firmware must be used/re-installed at the Version <b>2.5.x</b> .		
	EtherNet/IP Adapter (Slave)	<i>HILSCHER CIFX-RE EIS V1.1.EDS</i>	
	EtherNet/IP Scanner (Master)	<i>HILSCHER CIFX-RE EIM V1.0.eds</i>	
	 <b>Note!</b> The description files for the EtherNet/IP Master device is needed, when an additional EtherNet/IP Master device shall communicate to a Hilscher EtherNet/IP Master device via EtherNet/IP.		
	POWERLINK Controlled Node/Slave	<i>00000044_CIFX RE PLS.xdd</i>	
	PROFINET IO-Device	For the PROFINET IO Device Firmware V3.4: <i>GSDML-V2.3-HILSCHER-CIFX RE PNS-20130806.xml</i>	
		For the PROFINET IO Device Firmware with V3.10 the <i>GSDML-V2.32-HILSCHER-CIFX RE PNS-20160502.xml</i> is provided.	
Sercos Slave	<i>SDDML#v3.0#Hilscher#CIFX_RE-FIXCFG_FSPIO#2014-01-08.xml, SDDML#v3.0#Hilscher#CIFX_RE-VARCFG_FSPDRIVE#2014-01-08.xml</i>		
 <b>Note!</b> If you use a Sercos Master which is using SDDML files for configuration, and one of the defaults for vendor code, device ID, input data size or output data size was changed, then you have to export a new updated SDDML file from SYCON.net and import this SDDML file into the configuration software for the Sercos Master.			

PC Cards cifX	System	File Name of the Device Description File
CIFX 50E-CCIES, CIFX 70E-CCIES	CC-Link IE Field Slave	<i>0x0352_CIFX.cspp</i>
CIFX 50-DP, CIFX 50-2DP, CIFX 50E-DP, CIFX 50E-2DP, CIFX 70E-DP, CIFX 70E-DP\MR	PROFIBUS DP Slave	<i>HIL_0B69.GSD</i>
CIFX 50-2DP\CO, CIFX 50E-2DP\CO	PROFIBUS DP-Slave CANopen-Slave	<i>HIL_0B69.GSD</i> <i>CIFX_CO_COS.eds</i>
CIFX 50-2DP\DN, CIFX 50E-2DP\DN	PROFIBUS DP-Slave DeviceNet-Slave	<i>HIL_0B69.GSD</i> <i>CIFX_DN_DNS.EDS</i>
CIFX 50-CO, CIFX 50-2CO, CIFX 50E-CO, CIFX 50E-2CO, CIFX 70E-CO, CIFX 70E-COMR	CANopen Slave	<i>CIFX_CO_COS.eds</i>
CIFX 50-2CO\DN, CIFX 50E- 2CO\DN	CANopen-Slave DeviceNet-Slave	<i>CIFX_CO_COS.eds</i> <i>CIFX_DN_DNS.EDS</i>
CIFX 50-DN, CIFX 50-2DN, CIFX 50E-DN, CIFX 50E-2DN, CIFX 70E-DN, CIFX 70E-DN\MR	DeviceNet Slave	<i>CIFX_DN_DNS.EDS</i>
CIFX 50-CC, CIFX 50E-CC	CC-Link Slave	<i>0x0352_CIFX-CCS_2.11_en.cspp,</i> <i>CIFX\0x0352_CIFX-CCS_2.11_en.cspproj</i>

Table 11: Device Description Files for PC Cards cifX

## 1.3 Legal Notes

### Copyright

© Hilscher Gesellschaft für Systemautomation mbH

All rights reserved.

The images, photographs and texts in the accompanying materials (in the form of a user's manual, operator's manual, Statement of Work document and all other document types, support texts, documentation, etc.) are protected by German and international copyright and by international trade and protective provisions. Without the prior written consent, you do not have permission to duplicate them either in full or in part using technical or mechanical methods (print, photocopy or any other method), to edit them using electronic systems or to transfer them. You are not permitted to make changes to copyright notices, markings, trademarks or ownership declarations. Illustrations are provided without taking the patent situation into account. Any company names and product designations provided in this document may be brands or trademarks by the corresponding owner and may be protected under trademark, brand or patent law. Any form of further use shall require the express consent from the relevant owner of the rights.

### Important notes

Utmost care was/is given in the preparation of the documentation at hand consisting of a user's manual, operating manual and any other document type and accompanying texts. However, errors cannot be ruled out. Therefore, we cannot assume any guarantee or legal responsibility for erroneous information or liability of any kind. You are hereby made aware that descriptions found in the user's manual, the accompanying texts and the documentation neither represent a guarantee nor any indication on proper use as stipulated in the agreement or a promised attribute. It cannot be ruled out that the user's manual, the accompanying texts and the documentation do not completely match the described attributes, standards or any other data for the delivered product. A warranty or guarantee with respect to the correctness or accuracy of the information is not assumed.

We reserve the right to modify our products and the specifications for such as well as the corresponding documentation in the form of a user's manual, operating manual and/or any other document types and accompanying texts at any time and without notice without being required to notify of said modification. Changes shall be taken into account in future manuals and do not represent an obligation of any kind, in particular there shall be no right to have delivered documents revised. The manual delivered with the product shall apply.

Under no circumstances shall Hilscher Gesellschaft für Systemautomation mbH be liable for direct, indirect, ancillary or subsequent damage, or for any loss of income, which may arise after use of the information contained herein.

### Liability disclaimer

The hardware and/or software was created and tested by Hilscher Gesellschaft für Systemautomation mbH with utmost care and is made available as is. No warranty can be assumed for the performance or flawlessness of the hardware and/or software under all application

conditions and scenarios and the work results achieved by the user when using the hardware and/or software. Liability for any damage that may have occurred as a result of using the hardware and/or software or the corresponding documents shall be limited to an event involving willful intent or a grossly negligent violation of a fundamental contractual obligation. However, the right to assert damages due to a violation of a fundamental contractual obligation shall be limited to contract-typical foreseeable damage.

It is hereby expressly agreed upon in particular that any use or utilization of the hardware and/or software in connection with

- Flight control systems in aviation and aerospace;
- Nuclear fusion processes in nuclear power plants;
- Medical devices used for life support and
- Vehicle control systems used in passenger transport

shall be excluded. Use of the hardware and/or software in any of the following areas is strictly prohibited:

- For military purposes or in weaponry;
- For designing, engineering, maintaining or operating nuclear systems;
- In flight safety systems, aviation and flight telecommunications systems;
- In life-support systems;
- In systems in which any malfunction in the hardware and/or software may result in physical injuries or fatalities.

You are hereby made aware that the hardware and/or software was not created for use in hazardous environments, which require fail-safe control mechanisms. Use of the hardware and/or software in this kind of environment shall be at your own risk; any liability for damage or loss due to impermissible use shall be excluded.

### **Warranty**

Hilscher Gesellschaft für Systemautomation mbH hereby guarantees that the software shall run without errors in accordance with the requirements listed in the specifications and that there were no defects on the date of acceptance. The warranty period shall be 12 months commencing as of the date of acceptance or purchase (with express declaration or implied, by customer's conclusive behavior, e.g. putting into operation permanently).

The warranty obligation for equipment (hardware) we produce is 36 months, calculated as of the date of delivery ex works. The aforementioned provisions shall not apply if longer warranty periods are mandatory by law pursuant to Section 438 (1.2) BGB, Section 479 (1) BGB and Section 634a (1) BGB [Bürgerliches Gesetzbuch; German Civil Code] If, despite of all due care taken, the delivered product should have a defect, which already existed at the time of the transfer of risk, it shall be at our discretion to either repair the product or to deliver a replacement product, subject to timely notification of defect.

The warranty obligation shall not apply if the notification of defect is not asserted promptly, if the purchaser or third party has tampered with the products, if the defect is the result of natural wear, was caused by unfavorable operating conditions or is due to violations against our operating regulations or against rules of good electrical engineering



practice, or if our request to return the defective object is not promptly complied with.

### **Costs of support, maintenance, customization and product care**

Please be advised that any subsequent improvement shall only be free of charge if a defect is found. Any form of technical support, maintenance and customization is not a warranty service, but instead shall be charged extra.

### **Additional guarantees**

Although the hardware and software was developed and tested in-depth with greatest care, Hilscher Gesellschaft für Systemautomation mbH shall not assume any guarantee for the suitability thereof for any purpose that was not confirmed in writing. No guarantee can be granted whereby the hardware and software satisfies your requirements, or the use of the hardware and/or software is uninterrupted or the hardware and/or software is fault-free.

It cannot be guaranteed that patents and/or ownership privileges have not been infringed upon or violated or that the products are free from third-party influence. No additional guarantees or promises shall be made as to whether the product is market current, free from deficiency in title, or can be integrated or is usable for specific purposes, unless such guarantees or promises are required under existing law and cannot be restricted.

### **Confidentiality**

The customer hereby expressly acknowledges that this document contains trade secrets, information protected by copyright and other patent and ownership privileges as well as any related rights of Hilscher Gesellschaft für Systemautomation mbH. The customer agrees to treat as confidential all of the information made available to customer by Hilscher Gesellschaft für Systemautomation mbH and rights, which were disclosed by Hilscher Gesellschaft für Systemautomation mbH and that were made accessible as well as the terms and conditions of this agreement itself.

The parties hereby agree to one another that the information that each party receives from the other party respectively is and shall remain the intellectual property of said other party, unless provided for otherwise in a contractual agreement.

The customer must not allow any third party to become knowledgeable of this expertise and shall only provide knowledge thereof to authorized users as appropriate and necessary. Companies associated with the customer shall not be deemed third parties. The customer must obligate authorized users to confidentiality. The customer should only use the confidential information in connection with the performances specified in this agreement.

The customer must not use this confidential information to his own advantage or for his own purposes or rather to the advantage or for the purpose of a third party, nor must it be used for commercial purposes and this confidential information must only be used to the extent provided for in this agreement or otherwise to the extent as expressly authorized by the disclosing party in written form. The customer has the right, subject to the obligation to confidentiality, to disclose the terms and conditions of this agreement directly to his legal and financial consultants as would be required for the customer's normal business operation.

## Export provisions

The delivered product (including technical data) is subject to the legal export and/or import laws as well as any associated regulations of various countries, especially such laws applicable in Germany and in the United States. The products / hardware / software must not be exported into such countries for which export is prohibited under US American export control laws and its supplementary provisions. You hereby agree to strictly follow the regulations and to yourself be responsible for observing them. You are hereby made aware that you may be required to obtain governmental approval to export, reexport or import the product.

## 1.4 Registered Trademarks

**Windows® XP, Windows® Vista, Windows® 7, Windows® 8, Windows® 8.1 and Windows® 10** are registered trademarks of Microsoft Corporation.

Linux is a registered trademark of Linus Torvalds.

QNX is a registered trademark of QNX Software Systems, Ltd.

VxWorks is a registered trademark of Wind River Systems, Inc.

IntervalZero RTX™ is a trademark of IntervalZero.

Adobe-Acrobat® is a registered trademark of the Adobe Systems Incorporated.

CANopen® is a registered trademark of CAN in AUTOMATION - International Users and Manufacturers Group e.V (CiA), Nürnberg.

CC-Link and CC-Link IE Field are registered trademarks of Mitsubishi Electric Corporation, Tokyo, Japan.

is a registered trademark of Mitsubishi Electric Corporation, Tokyo, Japan.

DeviceNet™ and EtherNet/IP™ are trademarks of ODVA (Open DeviceNet Vendor Association, Inc).

EtherCAT® is a registered trademark and a patented technology of Beckhoff Automation GmbH, Verl, Germany, formerly Elektro Beckhoff GmbH.

Modbus is a registered trademark of Schneider Electric.

POWERLINK is a registered trademark of B&R, Bernecker + Rainer Industrie-Elektronik Ges.m.b.H, Eggelsberg, Austria

PROFIBUS® and PROFINET® are registered trademarks of PROFIBUS & PROFINET International (PI), Karlsruhe.

Sercos and Sercos interface are registered trademarks of Sercos international e. V., Suessen, Germany.

PCI™, PCI EXPRESS® and PCIe® are trademarks or registered trademarks of the Peripheral Component Interconnect Special Interest Group (PCI-SIG).

**All other mentioned trademarks are property of their respective legal owners.**

## 1.4.1 EtherCAT Disclaimer

EtherCAT® is registered trademark and patented technology, licensed by Beckhoff Automation GmbH, Germany.



To get details and restrictions regarding using the EtherCAT technology refer to the following documents:

- “EtherCAT Marking rules”
- “EtherCAT Conformance Test Policy”
- “EtherCAT Vendor ID Policy”

These documents are available at the ETG homepage [www.ethercat.org](http://www.ethercat.org) or directly over [info@ethercat.org](mailto:info@ethercat.org).

A summary over Vendor ID, Conformance test, Membership and Network Logo can be found within the appendix section of this document under section *EtherCAT Summary over Vendor ID, Conformance test, Membership and Network Logo* on page 266.

## 1.5 Obligation to read and understand the Manual



### Important!

- To avoid personal injury and to avoid property damage to your system or to your PC card, you must read and understand all instructions in the manual and all accompanying texts to your PC card, before installing and operating your PC card.
- First read the **Safety Instructions** in the safety chapter.
- Obey to all **Safety Messages** in the manual.
- Keep the product DVD as ZIP file providing the product manuals.

## 1.6 Licenses

If a PC Card cifX is used as a Slave, neither for the firmware nor for the configuration software SYCON.net a license is required.

Licenses will be required if the PC Card cifX is used with

- a firmware with master functionality\*.

\* The master license includes the PC Card cifX operating as master and the license for the configuration software SYCON.net for the respective cifX.

### 1.6.1 License Note about VARAN Client

In order to use the PC Card cifX with VARAN, you need a license which you can acquire at the VNO (VARAN Bus-Nutzerorganisation, Bürmooser Straße 10, A-5112 Lamprechtshausen, [info@varan-bus.net](mailto:info@varan-bus.net)) after getting a member of VON.

The license as well as the Vendor ID and the Device ID can be adjusted with the SYCON.net configuration software or with the netX Configuration Tool.

## 2 Safety

### 2.1 General Note

The documentation in the form of a user manual, an operating instruction manual or other manual types, as well as the accompanying texts have been created for the use of the products by educated personnel. When using the products, all Safety Messages, Integrated Safety Messages, Property Damage Messages and all valid legal regulations must be obeyed. Technical knowledge is presumed. The user has to assure that all legal regulations are obeyed.

### 2.2 Intended Use

The PC Cards cifX described in this user manual are PC cards for the Real-Time Ethernet or fieldbus communication. Depending from the loaded firmware, the Real-Time Ethernet or fieldbus systems listed in the following table can be realized using the respective PC Card cifX.

PC Cards cifX	Real-Time Ethernet System	PC Cards cifX	Fieldbus System
CIFX 50-RE, CIFX 50E-RE, CIFX 50E-RE\ET, CIFX 70E-RE, CIFX 70E-RE\MR, CIFX 100EH- RE\CUBE	CC-Link IE Field Basic Slave	CIFX 50-DP CIFX 50E-DP, CIFX 70E-DP, CIFX 70E-DP\MR	PROFIBUS DP Master, PROFIBUS DP Slave, PROFIBUS MPI Device
	EtherCAT Master, EtherCAT Slave	CIFX 50-2DP, CIFX 50E-2DP	PROFIBUS DP Master, PROFIBUS DP Slave
	EtherNet/IP Scanner (Master), EtherNet/IP Adapter (Slave)	CIFX 50-2DP\CO, CIFX 50E-2DP\CO	PROFIBUS DP Master, PROFIBUS DP Slave, CANopen Master, CANopen Slave
	Open-Modbus/TCP POWERLINK-Controlled-Node/Slave PROFINET IO-Controller (Master), PROFINET IO-Device (Slave)	CIFX-50-2DP\DN, CIFX 50E-2DP\DN	PROFIBUS DP Master, PROFIBUS DP Slave, DeviceNet Master, DeviceNet Slave
Sercos Master, Sercos Slave VARAN-Client (Slave)			
CIFX 50E-CCIES, CIFX 70E-CCIES	CC-Link IE Field Slave	CIFX 50-CO CIFX 50-2CO CIFX 50E-CO, CIFX 50E-2CO, CIFX 70E-CO, CIFX 70E-CO\MR	CANopen Master, CANopen Slave
		CIFX 50-2CO\DN, CIFX 50E-2CO\DN	CANopen Master, CANopen Slave DeviceNet Master, DeviceNet Slave
		CIFX 50-DN CIFX 50-2DN CIFX 50E-DN, CIFX 50E-2DN, CIFX 70E-DN, CIFX 70E-DN\MR	DeviceNet Master, DeviceNet Slave
		CIFX 50-2ASM, CIFX 50E-2ASM	AS-Interface Master
		CIFX 50-CC CIFX 50E-CC	CC-Link Slave

Table 12: PC Cards cifX and the Real-Time Ethernet or Fieldbus Systems realized thereby

## 2.3 Personnel Qualification

The PC Card cifX must only be installed, configured and removed by qualified personnel. Job-specific technical skills for people professionally working with electricity must be present concerning the following topics:

- Safety and health at work
- Mounting and connecting of electrical equipment
- Measurement and Analysis of electrical functions and systems
- Evaluation of the safety of electrical systems and equipment
- Installing and Configuring IT systems.

## 2.4 Safety Instructions

To ensure your own personal safety and to avoid personal injury, you necessarily must read, understand, and comply with the safety instructions and safety messages in this manual before you install and operate your PC card cifX.

For cases if both, personal injury as well as property damage (damage of equipment or device) may occur together, you find the safety instructions in this section.

### 2.4.1 Electrical Shock Hazard

The danger of a lethal electrical shock caused by parts with more than 50V may occur if you open the PC cabinet to install the PC Card cifX.

- HAZARDOUS VOLTAGE is present inside of the PC or of the connecting device, into which the PC Card cifX is integrated. Strictly obey to all safety rules provided by the device's manufacturer in the documentation!
- First disconnect the power plug of the PC or of the connecting device, before you open the cabinet.
- Make sure, that the power supply is off at the PC or at the connecting device.
- Open the PC cabinet and install or remove the PC Card cifX only after disconnecting power.

Reference Safety [S2]

## 2.4.2 Communication Stop during Firmware Update or Configuration Download

If you want to perform either a firmware update (as a download) or a configuration download, both via the corresponding Master DTM in SYCON.net, be aware of the following:

- Together with the firmware download, an automated reset to the device is performed that will interrupt all network communication and all established connections will drop.
- If you download the configuration during bus operation, the communication between master and slaves is stopped.

### **Possible faulty System Operation**

- An unpredictable and unexpected behavior of machines and plant components may cause personal injury and property damage.
- Stop the application program, before starting the firmware update or before downloading the configuration.
- Make sure that your equipment operates under conditions that prevent personal injury or property damage. All network devices should be placed in a fail-safe mode, before starting the firmware update or before downloading a configuration.

### **Loss of Device Parameters, Overwriting of Firmware**

- Both the firmware download and the configuration download erase the configuration data base. The firmware download overwrites the existing firmware in the network device.
- To complete the firmware update and to make the device operable again, re-load the configuration after the firmware update has been finished.

For devices with Ethernet technology

- Device parameters that have been saved volatile, e. g. as the temporarily set IP address parameters, are getting lost during the reset.
- In order to prevent loss of configuration data, make sure that your project configuration data are saved non-volatile, before you initiate a firmware update or download the configuration.

## 2.4.3 Mismatching System Configuration

Mismatching system configuration loaded into the device could result in faulty data mapping in the application program and thus unexpected equipment operation may cause personal injury or damage of equipment.

- In the device use only a configuration suitable for the system.

## 2.5 Property Damage

To avoid system damage and device damage to the PC card cifX, you necessarily must read, understand, and comply with the safety instructions and safety messages in this manual before you install and operate the PC card cifX.

### 2.5.1 Exceeding permissible Supply Voltage

To avoid device damage due to high supply voltage to your PC Card cifX, you must observe the following instructions. These instructions apply to all PC Cards cifX described in this manual.

The PC Card cifX may only be operated with the specified supply voltage. Make sure that the limits of the permissible range for the supply voltage are not exceeded. A supply voltage above the upper limit can cause severe damage to the PC Card cifX! A supply voltage below the lower limit can cause malfunction in the PC Card cifX. The permissible range for the supply voltage is defined by the tolerances specified in this manual.

For the PC cards listed hereafter adhere specifically: The PC Card cifX

- CIFX 50-RE
- CIFX 50-DP, CIFX 50-2DP, CIFX 50-2DP\CO, CIFX 50-2DP\DN, CIFX 50-CO, CIFX 50-2CO, CIFX 50-2CO\DN, CIFX 50-DN, CIFX 50-2DN, CIFX 50-2ASM, CIFX 50-CC
- CIFX 50E-RE, CIFX 50E-RE\ET
- CIFX 50E-CCIES,
- CIFX 50E-DP, CIFX 50E-2DP, CIFX 50E-2DP\CO, CIFX 50E-2DP\DN, CIFX 50E-CO, CIFX 50E-2CO, CIFX 50E-2CO\DN, CIFX 50E-DN, CIFX 50E-2DN, CIFX 50E-2ASM, CIFX 50E-CC
- CIFX 70E-RE, CIFX 70E-RE\MR, CIFX 100EH-RE\CUBE
- CIFX 70E-CCIES
- CIFX 70E-DP, CIFX 70E-DP\MR
- CIFX 70E-CO, CIFX 70E-CO\MR
- CIFX 70E-DN, CIFX 70E-DN\MR

may not be powered by a 5V supply voltage! The PC Card cifX may only be powered by a 3.3 V dc  $\pm 5\%$  supply voltage.



The data on the mandatory supply voltage for the PC Cards cifX described in this manual you find in section *Power Supply and Host Interface* on page 44. There the required and permitted supply voltage is provided by device type inclusively the permitted tolerance range.

## 2.5.2 Exceeding permissible Signaling Voltage

To avoid device damage due to high signal voltage to your PC Card cifX, you must observe the following instructions. These instructions apply to all PC Cards cifX described in this manual.

- All I/O signal pins at the PC Card cifX tolerate only the specified signaling voltage!
- Operating of your PC Card cifX with a signaling voltage other than the specified signaling voltage may lead to severe damage to the PC Card cifX!



The data on the mandatory signaling voltage for the PC Cards cifX described in this manual you find in the section *Power Supply and Host Interface* on page 44. There the required and permitted signaling voltage is provided by device type.

## 2.5.3 Electrostatically sensitive Devices

This equipment is sensitive to electrostatic discharge, which cause internal damage and affect normal operation. Therefore adhere to the necessary safety precautions for components that are vulnerable with electrostatic discharge if you install or replace your device. Follow the guidelines listed hereafter when you handle this equipment:

- Touch a grounded object to discharge potential static.
- Wear an approved grounding wriststrap.
- Do not touch connectors or pins on the PC Card cifX.
- Do not touch circuit components inside the equipment.
- If available, use a static-safe workstation.
- When not in use, store the equipment in appropriate static-safe packaging.

Reference Safety [S3]



## 2.5.4 Power Disconnect while downloading Firmware or Configuration

If during the process of downloading a firmware or configuration

- the power supply to a PC with the software application is interrupted,
- or the power supply to the PC card cifX is interrupted,
- or a reset to the PC card cifX is performed,

this may lead to the following consequences:

### **Loss of Device Parameters, Firmware Corruption**

- The firmware download or the configuration download will be interrupted and remains incomplete.
- The firmware or the configuration database will be corrupted and device parameters will be lost.
- Device damage may occur as the PC card cifX cannot be rebooted.

Whether these consequences occur depends on when the power disconnect occurs during the download.

- During configuration download process, do not interrupt the power supply to the PC, or to the PC card cifX and do not perform a reset!

Otherwise you might be forced to return your PC card cifX for repair.

### **Power Drop during Write and Delete Accesses in the File System**

The FAT file system in the netX firmware is subject to certain limitations in its operation. Write and delete accesses in the file system (firmware update, configuration download etc.) can destroy the FAT (File Allocation Table) if the accesses cannot be completed if the power drops. Without a proper FAT, a firmware may not be found and cannot be started.

Make sure that the power supply to the device is not interrupted during write and delete accesses in the file system (firmware update, configuration download, etc.).

## 2.5.5 Exceeding the maximum Number of allowed Write/Delete Accesses

**This device uses a serial Flash chip** for storing remanent data, such as firmware, configuration, etc. This chip allows a maximum of 100 000 write/delete accesses which is sufficient for a standard device operation. Writing/deleting the chip excessively (e.g. in order to change configuration or name of station) will exceed the maximum number of allowed write/delete accesses and, thus, result in damage to the device. If, e.g., the configuration is changed every hour, the maximum number will be reached after 11.5 years. If, e.g., it is changed every minute, the maximum number will already be reached after approx. 69 days.

Avoid exceeding the maximum number of allowed write/delete accesses by excessive writing.

## 2.5.6 Invalid Firmware

Loading invalid firmware files could render your device unusable.

- Only download firmware files to your PC Card cifX that are valid for this device.

Otherwise you may be forced to return your device for repair.

## 2.5.7 Information and Data Security

Take all usual measures for information and data security, in particular for PC Cards cifX with Ethernet technology. Hilscher explicitly points out that a device with access to a public network (Internet) must be installed behind a firewall or only be accessible via a secure connection such as an encrypted VPN connection. Otherwise the integrity of the device, its data, the application or system section is not safeguarded.

Hilscher can assume no warranty and no liability for damages due to neglected security measures or incorrect installation.

## 2.6 Labeling of Safety Messages

- The **Section Safety Messages** at the beginning of a chapter are pinpointed particularly and highlighted by a signal word according to the degree of endangerment. The type of danger is specified by the safety message text and optionally by a specific safety sign.
- The **Integrated Safety Messages** within an instruction description are highlighted with a signal word according to the degree of endangerment. The type of danger is specified by the safety message text.





Signal Word	Meaning (International)	Meaning (USA)
 <b>DANGER</b>	Indicates a direct hazard with high risk, which will have a consequence of death or grievous bodily harm if it is not avoided.	Indicates a hazardous situation which if not avoided, will result in death or serious injury.
 <b>WARNING</b>	Indicates a possible hazard with medium risk, which will have a consequence of death or (grievous) bodily harm if it is not avoided.	Indicates a hazardous situation which if not avoided, could result in death or serious injury.
 <b>CAUTION</b>	Indicates a minor hazard with medium risk, which could have a consequence of minor or moderate bodily harm if it is not avoided.	Indicates a hazardous situation which if not avoided, may result in minor or moderate Injury.
 <b>NOTICE</b>	Indicates a property damage message.	Indicates a property damage message.

Table 13: Signal Words







Safety Sign	USA	Warning or Principle
		Warning of lethal electrical shock
		Principle: Disconnect the power plug
		Warning on damages by electrostatic discharge
		Warning of device damage, for example due to exceedingly high supply voltage or exceedingly high signaling voltage.
		Warning of device damage, for example due to power disconnect during firmware update or configuration download, exceeding the maximum number of allowed write/delete accesses or due to invalid or non-authorized firmware.

Table 14: Safety Signs



**Note:** The ANSI Z535.6 standard specifies in section 4.8: "Messages about hazards that could result in both, physical injury and property damage are considered safety messages, not property damage messages." Thus depending of the type of danger and its consequences, warning messages marked by a signal word DANGER, WARNING or CAUTION may include both, messages on physical injury and property damage.

In this document, all Safety Instructions and Safety Messages are designed according both to the international used safety conventions as well as to the ANSI Z535.6 standard, refer to safety reference [S1].

## 2.7 References Safety

- [S1] ANSI Z535.6-2011 American National Standard for Product Safety Information in Product Manuals, Instructions, and Other Collateral Materials
- [S2] DIN EN 62368-1: 2016-05, Audio/video, information and communication technology equipment - Part 1: Safety requirements (IEC 62368-1: 2014, modified + Cor.:2015); German version EN 62368-1: 2014 + AC: 2015
- [S3] EN 61340-5-1 and EN 61340-5-2 as well as IEC 61340-5-1 and IEC 61340-5-2

### 3 Descriptions and Requirements

#### 3.1 Description

The PC Cards cifX are communication interfaces of the cifX product family of Hilscher on the basis of the communication controller netX 100 for the Real-Time Ethernet or fieldbus communication. Depending of the loaded firmware, the protocol specific PC Card cifX proceeds the communication of the corresponding Real-Time Ethernet or fieldbus system.

The used Real-Time Ethernet systems are:      The used fieldbus systems are:

- |  |  |
|--|--|
| <ul style="list-style-type: none"> <li>▪ CC-Link IE Field Basic Slave</li> <li>▪ CC-Link IE Field Slave</li> <li>▪ EtherCAT Master</li> <li>▪ EtherCAT Slave</li> <li>▪ EtherNet/IP Scanner (Master)</li> <li>▪ EtherNet/IP Adapter (Slave)</li> <li>▪ Open-Modbus/TCP</li> <li>▪ POWERLINK-Controlled-Node/Slave</li> <li>▪ PROFINET IO-Controller (Master)</li> <li>▪ PROFINET IO-Device (Slave)</li> <li>▪ Sercos Master</li> <li>▪ Sercos Slave</li> <li>▪ VARAN Client (Slave)</li> </ul> | <ul style="list-style-type: none"> <li>▪ PROFIBUS DP Master</li> <li>▪ PROFIBUS DP Slave</li> <li>▪ PROFIBUS MPI Device</li> <li>▪ CANopen Master</li> <li>▪ CANopen Slave</li> <li>▪ DeviceNet Master</li> <li>▪ DeviceNet Slave</li> <li>▪ AS-Interface Master</li> <li>▪ CC-Link Slave</li> </ul> |
|--|--|

The PC Card cifX handles the complete data exchange between the connected Ethernet or fieldbus devices and the PC. The data exchange is proceeded via dual-port memory.

#### 3.2 PC Cards PCI CIFX 50-XX

PC Card cifX	Description
<b>PC Cards PCI with integrated Ethernet or fieldbus interface</b>	
<b>Real-Time Ethernet</b>	
CIFX 50-RE	Real-Time Ethernet Master or Slave.
<b>PROFIBUS</b>	
CIFX 50-DP	PROFIBUS DP Master or Slave and PROFIBUS MPI Device
<b>CANopen</b>	
CIFX 50-CO	CANopen Master or Slave
<b>DeviceNet</b>	
CIFX 50-DN	DeviceNet Master or Slave
<b>CC-Link</b>	
CIFX 50-CC	CC-Link Slave

Table 15: PC Cards PCI CIFX 50-XX

### 3.3 PC Cards PCI (2 Channels) CIFX 50-2XX, CIFX 50-2XX\XX

PC Card cifX	Description
<b>PC Cards PCI with two integrated fieldbus interfaces (2 Channels)</b>	
<b>PROFIBUS</b>	
CIFX 50-2DP	2 x PROFIBUS DP Master or Slave
CIFX 50-2DP\CO	Channel X1: PROFIBUS DP Master or Slave, channel X2: CANopen Master or Slave
CIFX 50-2DP\DN	Channel X1: PROFIBUS DP Master or Slave, channel X2: DeviceNet Master or Slave
<b>CANopen</b>	
CIFX 50-2CO	2 x CANopen Master or Slave
CIFX 50-2CO\DN	Channel X1: CANopen Master or Slave, channel X2: DeviceNet Master or Slave
<b>DeviceNet</b>	
CIFX 50-2DN	2 x DeviceNet Master or Slave
<b>AS-Interface</b>	
CIFX 50-2ASM	2 x AS-Interface Master
CIFX 50E-2ASM	2 x AS-Interface Master

Table 16: PC Cards PCI (2 Channels) CIFX 50-2XX, CIFX 50-2XX\XX

### 3.4 PC Cards PCI Express CIFX 50E-XX, CIFX 70E-XX, CIFX 100EH-RE\CUBE

PC Card cifX	Description
<b>PC Cards PCI Express with integrated Ethernet or fieldbus interface</b>	
<b>Real-Time Ethernet</b>	
CIFX 50E-RE or CIFX 50E-RE\ET	Real-Time Ethernet Master or Slave <b>Note:</b> The PC card CIFX 50E-RE\ET can be used in an enlarged temperature range from -20°C to +70 °C.
CIFX 70E-RE, CIFX 70E-RE\MR	Low Profile PCI Express Real-Time-Ethernet Master or Slave (Low Profile PCIe with RTE)
CIFX 100EH-RE\CUBE	Real-Time Ethernet Master or Slave, (low-profile card) exclusively for the installing in KEBA KeControl industry PCs series CP 3XX (Cube).
<b>CC-Link IE Field Slave</b>	
CIFX 50E-CCIES	CC-Link IE Field Slave
CIFX 70E-CCIES	Low Profile PCI Express CC-Link IE Field Slave (Low Profile PCIe)
<b>PROFIBUS</b>	
CIFX 50E-DP	PROFIBUS DP Master or Slave and PROFIBUS MPI Device
CIFX 70E-DP, CIFX 70E-DP\MR	Low Profile PCI Express PROFIBUS DP Master or Slave and PROFIBUS MPI Device (Low Profile PCIe with PROFIBUS)
<b>CANopen</b>	
CIFX 50E-CO	CANopen Master or Slave
CIFX 70E-CO, CIFX 70E-CO\MR	Low Profile PCI Express CANopen Master or Slave (Low Profile PCIe with CANopen)
<b>DeviceNet</b>	
CIFX 50E-DN	DeviceNet Master or Slave
CIFX 70E-DN, CIFX 70E-DN\MR	Low Profile PCI Express DeviceNet Master or Slave (Low Profile PCIe with DeviceNet)
<b>CC-Link</b>	
CIFX 50E-CC	CC-Link Slave

Table 17: PC Cards PCI Express CIFX 50E-XX, CIFX 70E-XX



**Note:** The PC cards CIFX 70E-RE\MR, CIFX 70E-DP\MR, CIFX 70E-CO\MR and CIFX 70E-DN\MR additionally are equipped with an MRAM (128Kbyte = 64K Words). For further information refer to section *PC Cards cifX with additional MRAM* on page 42.

### 3.5 PC Cards PCI Express (2 Channels) CIFX 50E-2XX, CIFX 50E-2XX\XX

PC Card cifX	Description
<b>PC Cards PCI Express with two integrated fieldbus interfaces (2 Channels)</b>	
<b>PROFIBUS</b>	
CIFX 50E-2DP	2 x PROFIBUS DP Master or Slave
CIFX 50E-2DP\CO	Channel X1: PROFIBUS DP Master or Slave, channel X2: CANopen Master or Slave
CIFX 50E-2DP\DN	Channel X1: PROFIBUS DP-Master or Slave, channel X2: DeviceNet Master or Slave
<b>CANopen</b>	
CIFX 50E-2CO	2 x CANopen-Master or Slave
CIFX 50E-2CO\DN	Channel X1: CANopen Master or Slave, channel X2: DeviceNet Master or Slave
<b>DeviceNet</b>	
CIFX 50E-2DN	2 x DeviceNet Master or Slave

Table 18: PC Cards PCI Express (2 Channels) CIFX 50E-2XX, CIFX 50E-2XX\XX

### 3.6 The Function „Slot Number (Card ID)“

Device revisions equipped with a **Rotary Switch Slot Number (Card ID)** are listed separately in section *Hardware: PC Cards cifX* on page 10 in *Table 2*.

The **Slot Number (Card ID)** must be set at the PC card cifX using the **Rotary Switch Slot Number (Card ID)**. The **Slot Number (Card ID)** will serve to distinguish PC cards cifX from each other clearly, especially if several PC cards cifX are installed into the very same PC. The application program requests the **Slot Number (Card ID)** from the PC card cifX via the **cifX Device Driver**.



For further information refer to section *Rotary Switch for Slot Number (Card ID)* on page 141.

#### 3.6.1 Requirements „Slot Number (Card ID)“

For the application program is able to identify a PC card cifX via its **Slot Number (Card ID)** explicitly and to distinguish it from other PC cards cifX in the PC, for device revisions equipped with a **Rotary Switch for Slot Number (Card ID)** the required versions of the firmware, the driver, the bootloader and the SYCON.net setup must be used:

**PC Cards with one Channel:**

PC Card cifX	From Hardware Revision	Firmware File	Protocol	From Firmware Version
CIFX 50-RE, CIFX 50E-RE, CIFX 50E-RE\ET, CIFX 70E-RE, CIFX 70E-RE\MR, CIFX 100EH-RE\CUBE	3	C020Y000.NXF	CC-Link IE Field-Basic-Slave	1.1
	1	CIFXECM.NXF	EtherCAT-Master	4.3 (V4)
	4	CIFXECM.NXF	EtherCAT Master	2.4.3.x
	1	CIFXECS.NXF	EtherCAT-Slave	4.5 (V4)
	1	CIFXECS.NXF	EtherCAT Slave	2.5.5
	1	CIFXEIM.NXF	EtherNet/IP Scanner	2.2.1
	1	CIFXEIS.NXF	EtherNet/IP Adapter	2.3.29
	1	CIFXOMB.NXF	Open-Modbus/TCP	2.3.3
	1	CIFXPLS.NXF	POWERLINK Controlled Node	2.1.19
	1	C010C000.NXF	PROFINET IO-Controller	3.2 (V3)
	1	CIFXPNM.NXF	PROFINET IO Controller	2.3
	1	CIFXPNS.NXF	PROFINET IO Device	3.3.6 (V3)
	1	CIFXS3M.NXF	Sercos Master	2.0.9
	1	CIFXS3S.NXF	Sercos Slave	3.0.8
1	CIFXVRS.NXF	VARAN Client	1.0	
CIFX 50E-CCIES, CIFX 70E-CCIES	1	C020X000.NXF	CC-Link IE Field Slave	1.1
CIFX 50-DP, CIFX 50E-DP, CIFX 70E-DP, CIFX 70E-DP\MR	5	CIFXDPM.NXF	PROFIBUS DP Master	2.3
	5	CIFXDPS.NXF	PROFIBUS DP Slave	2.3
	1	CIFXMPI.NXF	PROFIBUS MPI Device	2.2.5
CIFX 50-CO, CIFX 50E-CO, CIFX 70E-CO, CIFX 70E-CO\MR	5	CIFXCOM.NXF	CANopen Master	2.3
	4	CIFXCOS.NXF	CANopen Slave	2.3
	1			
CIFX 50-DN, CIFX 50E-DN, CIFX 70E-DN, CIFX 70E-DN\MR	5	CIFXDNM.NXF	DeviceNet Master	2.2
	4	CIFXDNS.NXF	DeviceNet Slave	2.2
	1			
	1			
CIFX 50-CC, CIFX 50E-CC	2	CIFXCPS.NXF	CC-Link Slave	2.4
	2			

*Table 19: Firmware Versions for the Function Slot Number (Card ID), (for 1 Channel Systems)*

**PC Cards PCI and PCI Express with two Channels:**

PC Card cifX	From Hardware Revision	Firmware File	Protocol	From Firmware Version
CIFX 50-2DP, CIFX 50E-2DP	1	CIFX2DPM.NXF	PROFIBUS DP Master, 2 Channels	1.0 (new version counting)
		CIFX2DPS.NXF	PROFIBUS DP Slave, 2 Channels	1.0 (new version counting)
		C0201020.NXF	PROFIBUS DP-Master, 1 Channel + PROFIBUS DP Slave, 1 Channel	1.1
CIFX 50-2DP\CO, CIFX 50E-2DP\CO	1	C0201040.NXF	PROFIBUS DP Master, 1 Channel + CANopen Master, 1 Channel	1.0
		C0202050.NXF	PROFIBUS DP Slave, 1 Channel + CANopen Slave, 1 Channel	1.0
CIFX 50-2DP\DN, CIFX 50E-2DP\DN	1	C0201060.NXF	PROFIBUS DP Master, 1 Channel + DeviceNet Master, 1 Channel	1.0
		C0202070.NXF	PROFIBUS DP Slave, 1 Channel + DeviceNetSlave, 1 Channel	1.0
CIFX 50-2CO, CIFX 50E-2CO	1	C0204040.NXF	CANopen Master, 2 Channels	1.0
		C0205050.NXF	CANopen Slave, 2 Channels	1.0
		C0204050.NXF	CANopen Master, 1 Channel + CANopen Slave, 1 Channel	1.1
CIFX 50-2CO\DN, CIFX 50E-2CO\DN	1	C0204060.NXF	CANopen Master, 1 Channel + DeviceNet Master, 1 Channel	1.0
		C0205070.NXF	CANopen Slave, 1 Channel + DeviceNet Slave, 1 Channel	1.0
CIFX 50-2DN, CIFX 50E-2DN	1	C0206060.NXF	DeviceNet Master, 2 Channels	1.0
		C0207070.NXF	DeviceNet Slave, 2 Channels	1.0
		C0206070.NXF	DeviceNet-Master, 1 Channel + DeviceNet-Slave, 1 Channel	1.2
CIFX 50-2ASM, CIFX 50E-2ASM	2 2	CIFX2ASM.NXF	AS-Interface Master, 2 Channels	2.1

Table 20: Firmware Versions for the Function Slot Number (Card ID) (for 2 Channel Systems)

Driver and Software	Version or higher
<b>cifX Device Driver</b>	cifX Device Driver Setup.exe 0.95x
<b>SYCON.net</b>	SYCONnet netX setup.exe V1.201

Table 21: Versions Driver, Bootloader and SYCON.net for Function Slot Number (Card ID)

- The **cifX Device Driver** versions **0.950** and higher identify PC cards cifX alternatively via its **Slot Number (Card ID)** if this is supported by the hardware.
- The **cifX Device Driver** up to version **0.94x** identifies PC cards cifX via its device and serial number. For the device exchange service respectively a manual intervention is required.



### 3.7 The Function „DMA Mode“

Device revisions which provide **DMA Mode** are listed separately in section *Hardware: PC Cards cifX* on page 10 in *Table 2*.



**Note:** The functions **Slot Number (Card ID)** and **DMA Mode** are in technical view independently from each other.

The **DMA Mode** is activated via the device driver **cifX Device Driver**.



For further information refer to the user manual **Software Installation for the PC Cards cifX** in section *Activating DMA Mode in the cifX Device Driver Setup*.

#### 3.7.1 Requirements „DMA Mode“

For device revisions providing the **DMA Mode** the required versions of the firmware, the driver and the SYCON.net setup must be used:

##### PC Cards with one Channel:

PC Card cifX	From Hardware Revision	Firmware File	Protocol	From Firmware Version
CIFX 50-RE, CIFX 50E-RE, CIFX 50E-RE\ET, CIFX 70E-RE, CIFX 70E-RE\MR, CIFX 100EH-RE\CUBE	1	C020Y000.NXF	CC-Link IE Field-Basic-Slave	1.1
	1	CIFXECS.NXF	EtherCAT-Master	4.3 (V4)
	4	CIFXECS.NXF	EtherCAT-Master	2.4.6 (V2)
	1	CIFXECS.NXF	EtherCAT-Slave	4.5 (V4)
	1	CIFXECS.NXF	EtherCAT-Slave	2.5.5 (V2)
	1	CIFXEIM.NXF	EtherNet/IP Scanner	2.2
	1	CIFXEIS.NXF	EtherNet/IP Adapter	2.3
	1	CIFXOMB.NXF	Open-Modbus/TCP	2.4
	1	CIFXPLS.NXF	POWERLINK Controlled Node	2.1.24
	1	C010C000.NXF	PROFINET IO-Controller	3.2 (V3)
	1	CIFXPNM.NXF	PROFINET IO-Controller	2.3 (V2)
	1	CIFXPNS.NXF	PROFINET IO Device	3.4 (V3)
	1	CIFXS3M.NXF	Sercos Master	2.0.15
	1	CIFXS3S.NXF	Sercos Slave	3.0.15
1	CIFXVRS.NXF	VARAN Client	1.0	
CIFX 50E-CCIES, CIFX 70E-CCIES	1	C020X000.NXF	CC-Link IE Field Slave	1.1
CIFX 50-DP, CIFX 50E-DP, CIFX 70E-DP, CIFX 70E-DP\MR	1	CIFXDPM.NXF	PROFIBUS DP Master	2.3
	4	CIFXDPS.NXF	PROFIBUS DP Slave	2.3
	1	CIFXMPI.NXF	PROFIBUS MPI Device	<i>not supported</i>
CIFX 50-CO, CIFX 50E-CO, CIFX 70E-CO, CIFX 70E-CO\MR	1	CIFXCOM.NXF	CANopen Master	2.3
	4	CIFXCOS.NXF	CANopen Slave	2.3
CIFX 50-DN, CIFX 50E-DN, CIFX 70E-DN, CIFX 70E-DN\MR	1	CIFXDNM.NXF	DeviceNet Master	2.2
	4	CIFXDNS.NXF	DeviceNet Slave	2.2
	1			
CIFX 50-CC, CIFX 50E-CC	1 3	CIFXCCS.NXF	CC-Link Slave	2.4

Table 22: Firmware Versions for the DMA Mode (for 1 Channel Systems)

**PC Cards PCI and PCI Express with two Channels:**

PC Card cifX	From Hardware Revision	Firmware File	Protocol	From Firmware Version
CIFX 50-2DP, CIFX 50E-2DP	1	CIFX2DPM.NXF	PROFIBUS DP Master, 2 Channels	1.0 (new version counting)
		CIFX2DPS.NXF	PROFIBUS DP Slave, 2 Channels	1.0 (new version counting)
		C0201020.NXF	PROFIBUS DP-Master, 1 Channel + PROFIBUS DP Slave, 1 Channel	1.1
CIFX 50-2DP\CO, CIFX 50E-2DP\CO	1	C0201040.NXF	PROFIBUS DP Master, 1 Channel + CANopen Master, 1 Channel	1.0
		C0202050.NXF	PROFIBUS DP Slave, 1 Channel + CANopen Slave, 1 Channel	1.0
CIFX 50-2DP\DN, CIFX 50E-2DP\DN	1	C0201060.NXF	PROFIBUS DP Master, 1 Channel + DeviceNet Master, 1 Channel	1.0
		C0205070.NXF	PROFIBUS DP Slave, 1 Channel + DeviceNetSlave, 1 Channel	1.0
CIFX 50-2CO, CIFX 50E-2CO	1	C0204040.NXF	CANopen Master, 2 Channels	1.0
		C0205050.NXF	CANopen Slave, 2 Channels	1.0
		C0204050.NXF	CANopen Master, 1 Channel + CANopen Slave, 1 Channel	1.1
CIFX 50-2CO\DN, CIFX 50E-2CO\DN	1	C0204060.NXF	CANopen Master, 1 Channel + DeviceNet Master, 1 Channel	1.0
		C0205070.NXF	CANopen Slave, 1 Channel + DeviceNet Slave, 1 Channel	1.0
CIFX 50-2DN, CIFX 50E-2DN	1	C0206060.NXF	DeviceNet Master, 2 Channels	1.0
		C0207070.NXF	DeviceNet Slave, 2 Channels	1.0
		C0206070.NXF	DeviceNet-Master, 1 Channel + DeviceNet-Slave, 1 Channel	1.2
CIFX 50-2ASM, CIFX 50E-2ASM	2 4	CIFX2ASM.NXF	AS-Interface Master, 2 Channels	2.1

Table 23: Firmware Versions for the DMA Mode (for 2 Channel Systems)

Driver and Software	Version or higher
cifX Device Driver	cifX Device Driver Setup.exe 0.95x
SYCON.net	SYCONnet netX setup.exe V1.201

Table 24: Versions Driver and SYCON.net for the DMA Mode

### 3.8 PC Cards cifX with additional MRAM

The PC cards CIFX 70E-XX\MR (CIFX 70E-RE\MR, CIFX 70E-DP\MR, CIFX 70E-CO\MR and CIFX 70E-DN\MR) are identical to the PC cards CIFX 70E-XX and work with the same firmware. However, the PC cards CIFX 70E-XX\MR have an additional memory module for storing remanent data, MRAM with 128Kbyte (= 64K words). Using the cifX Device Driver (from Version 1.1.1.0) access from the application program to this memory is possible and it can be used as a remanent memory for the host system.

### 3.9 System Requirements

#### 3.9.1 Slot for the PC Cards cifX PCI, PCIe and Low Profile PCIe

PC with slot (3.3 V) for PC cards cifX *PCI, PCI Express and Low Profile PCI Express*:

PC Cards cifX	PCI Bus [Pins]	Slot
CIFX 50-RE CIFX 50-DP CIFX 50-2DP CIFX 50-2DP\CO CIFX 50-2DP\DN CIFX 50-CO CIFX 50-2CO CIFX 50-2CO\DN	124	<b>PCI slot (3.3 V)</b>
CIFX 50E-RE CIFX 50E-RE\ET CIFX 50E-CCIES CIFX 50E-DP CIFX 50E-2DP CIFX 50E-2DP\CO CIFX 50E-2DP\DN CIFX 50E-CO CIFX 50E-2CO CIFX 50E-2CO\DN CIFX 50E-DN CIFX 50E-2DN CIFX 50E-2ASM CIFX 50E-CC	36	<b>PCI Express x1 slot (3.3 V),</b> x1 <sup>1</sup> = One Lane [bus spec 3]
<div style="background-color: #0070C0; color: white; padding: 2px; text-align: center; font-weight: bold;">NOTICE</div> <p><b>Device Damage!</b></p> <p>The PC card CIFX 100EH-RE\CUBE may not be installed in standard PCs.</p> <p>The pin assignment of the PCI Express bus does not meet the standard [bus spec 3]. By consequence malfunction can occur at the PCI express bus.</p> <p>Install the PC card CIFX 100EH-RE\CUBE exclusively in KEBA KeControl industry PCs series CP 3XX (Cube).</p>		
CIFX 100EH-RE\CUBE	64	<b>PCI Express x4 slot (3.3 V) ,</b> x4 <sup>1</sup> = Four Lane  In the PCI Express x4 slot only lane 0 is used. For further details refer to section <i>Pin Assignment for PCI Express Bus CIFX 100EH-RE\CUBE</i> on page 146.

Table 25: Slot for the PC Cards cifX PCI, PCIe and Low Profile PCIe

<sup>1</sup> The terms "x1" or "x4" refer to the convention of the PCI Express specifications [bus spec 3] to the number of lanes in the slot.

### 3.9.2 Power Supply and Host Interface

For the power supply and the host interface used for the PC cards cifX *PCI*, *PCIe* and *Low Profile PCIe* you must observe the following requirements:

PC Cards cifX	Supply Voltage	Signaling Voltage Host Interface	Host Interface (PCI slot)
CIFX 50-RE CIFX 50-DN CIFX 50-DP CIFX 50-2DP, CIFX 50-2DP CIFX 50-2DP\CO CIFX 50-2DP\DN CIFX 50-CO CIFX 50-2CO CIFX 50-2CO\DN	CIFX 50-DN CIFX 50-2DN CIFX 50-CC CIFX 50-2ASM	+3.3 V dc $\pm 5\%$ / Max. 1 A	5 V or 3.3 V PCI
CIFX 50E-RE CIFX 50E-RE\ET CIFX 50E-CCIES CIFX 50E-DP CIFX 50E-2DP CIFX 50E-2DP\CO CIFX 50E-2DP\DN CIFX 50E-CO CIFX 50E-2CO CIFX 50E-2CO\DN CIFX 50E-DN CIFX 50E-2DN CIFX 50E-2ASM CIFX 50E-CC CIFX 100EH-RE\CUBE	CIFX 70E-RE CIFX 70E-RE\MR CIFX 70E-CCIES CIFX 70E-DP CIFX 70E-DP\MR CIFX 70E-CO CIFX 70E-CO\MR CIFX 70E-DN CIFX 70E-DN\MR	+3.3 V dc $\pm 5\%$ / Max. 1 A	PCIe-compatible PCI Express

Table 26: Requirements Power Supply and Host Interface for PC Cards cifX *PCI*, *PCIe* Low Profile *PCIe*

The data in the Table 26 above have the following meaning:

#### Supply Voltage

The required and permissible supply voltage at the PC card cifX *PCI*, *PCIe* and *Low Profile PCIe*.



**Note:** To ensure that the compatibility between different systems is guaranteed, providing a maximum of 1 A (for +3.3 VDC  $\pm 5\%$ ) is recommended.

The typical current consumption depends on the type of the PC card cifX. For detailed values on the typical current consumption see section *Technical Data PC Cards cifX* on page 147.

#### Signaling Voltage Host Interface

The required or tolerated signaling voltage at the I/O signal pins at the PCI bus of the PC cards cifX *PCI* or at the PCI express bus of the PC cards cifX *PCIe* and *Low Profile PCIe*.

**Host Interface (PCI slot)** Type of the host interface

### 3.9.3 Operating Temperature Range for UL Certificate

The UL certificate for the PC cards cifX is valid for the range 0°C to +55°C (for CIFX 100EH-RE 0°C to +65°C).

Regardless of this the PC cards cifX are designed for the operating temperatures (-20°C to +55°C or -20°C to +70°C) as specified in section *Technical Data PC Cards cifX* on page 147.

### 3.10 Requirements for Operation of the PC Card cifX

Operating the PC cards cifX properly, the following described requirements must be fulfilled.

<b>Protocols</b>	CC-Link IE Field Slave, EtherCAT Slave, EtherCAT Master, EtherNet/IP Adapter (Slave), EtherNet/IP Scanner (Master), Open-Modbus/TCP, POWERLINK-Controlled-Node/Slave,	PROFINET IO Device (Slave), PROFINET IO Controller (Master), Sercos Slave, Sercos Master, VARAN Client (Slave), PROFIBUS DP Slave, PROFIBUS DP Master,	PROFIBUS MPI Device CANopen Slave, CANopen Master, DeviceNet Slave, DeviceNet Master, AS-Interface Master; CC-Link Slave
<b>Software Installation</b>	<p>1. Driver for the Host Interface Host Interfaces: PCI and PCI Express</p> <ul style="list-style-type: none"> <li>The device driver <b>cifX Device Driver</b> must be installed (from V1.0). If you install the device into a PC, in general Windows® will be available as operating system. In this case the cifX Device Driver must be installed to communicate to the device and to exchange data via the dual-port memory.</li> </ul> <p><b>Important!</b> Upgrade older versions of the <b>cifX Device Driver</b> necessarily on the current version indicated in section <i>Driver and Software</i> on page 11. OR</p> <ul style="list-style-type: none"> <li>If Windows® is not available as operating system, an own driver must be developed using the cifX Driver Toolkit and this driver must be installed.</li> <li>For the operating systems Linux, Windows® CE, VxWorks, QNX and IntervalZero RTX™ you can buy Device Driver at the company Hilscher Gesellschaft für Systemautomation mbH <a href="http://www.hilscher.com/">http://www.hilscher.com/</a>.</li> </ul> <p>2. The configuration software <b>SYCON.net</b> or alternatively the simple Slave configuration tool <b>netX Configuration Tool</b> must be installed or another application program by which the PC card cifX (Slave) can be parameterized.</p>		
<b>How to use the Software</b>	<p>On how to use the software for the configuration, the firmware download and for the diagnosis, note the following notice:</p> <p><b>Important!</b> The <u>USB interface</u>, the <u>serial interface</u> as well as the <u>cifX Device Driver</u> may only be used exclusively by <b>one</b> software, that is</p> <ul style="list-style-type: none"> <li>- the <b>SYCON.net</b> configuration software (with integrated ODMV3) or</li> <li>- the <b>netX Configuration Tool</b> or</li> <li>- the <b>cifX Test Application</b> or</li> <li>- the <b>cifX Driver Setup Utility</b> or</li> <li>- the application program.</li> </ul> <p>Never use the listed software simultaneously, otherwise this will result in communication problems with the device.</p> <p>If the SYCON.net configuration software was used on the PC, then stop the ODMV3 service before you use one of the other software listed above. Therefore, select <b>Service &gt; Stop</b> from the context menu of the ODMV3 system tray icon.</p>		
<b>Firmware Download</b>	<p>3. Using the configuration software <b>SYCON.net</b> or for the Slave alternatively the Slave configuration tool <b>netX Configuration Tool</b>, the user must select and download the firmware to the PC card cifX.</p> <p>4. <b>Important!</b> Use the PC cards CIFX 50E-CCIES or CIFX 70E-CCIES only together with the CC-Link IE Field Slave firmware and do not use this firmware for any other cards.</p>		
<b>Parameter Setting</b>	<p>5. The PC card cifX must be parameterized using one of the following options:</p> <ul style="list-style-type: none"> <li>Configuration Software <b>SYCON.net</b></li> <li>alternatively Slave configuration tool <b>netX Configuration Tool</b> (only Slave, not for newer systems)</li> <li>Application program (programming required)</li> </ul>		
<b>Communication</b>	<p>6. For the communication of a PC card cifX (Slave) a Master device for the respective communication system is required. For the communication of a PC card cifX (Master) a Slave device for the respective communication system is required.</p>		
<b>PC Settings for PC Cards cifX PCI Express</b>	<p><b>Important!</b> If you install a PC card cifX PCI Express, you <u>always</u> must disable the Microsoft Windows "Link State Power Management". Otherwise, it cannot be excluded that your PC freezes during the PC card cifX PCI Express is in operation.</p>		
<b>Environmental Conditions</b>	<p>Due to a plug element from ERNI the lower limit of the operating temperature for all PC cards cifX Real-Time Ethernet is 0 °C. This applies to all hardware revisions of the PC card cifX Real-Time Ethernet, unless otherwise stated.</p>		

Table 27: Requirements to operate PC Cards cifX properly

## 3.11 Prerequisites for Certification

### 3.11.1 PROFINET IO Certification for IRT and SYNC0 Signal

#### 3.11.1.1 Providing SYNC0 Signal at SYNC Connector of the PC Card cifX



**Note:** A PROFINET IO certification for PROFINET IRT requires (mandatory) that your PC card cifX offers the synchronization signal (SYNC0), in order to allow e. g. connecting an oscilloscope. Therefore the SYNC connector of your PC card cifX must be accessible.

Information about where the SYNC connector is placed on your PC card cifX, you can find in the chapter *Device Drawings* on page 58.

#### 3.11.1.2 Using the SYNC0 Signal at the Host System

*Only valid for PC Card CIFX 100EH-RE\CUBE:*

If you forward the SYNC0 signal of your PC card cifX 100 EH-RE\CUBE to the PCI Express bus X2, you must adhere to the following design specification:



**Note:** A PROFINET IO certification for PROFINET IRT requires (mandatory) that the host system offers a connector for the synchronization signal (SYNC0), in order to allow e. g. connecting an oscilloscope.

For this purpose you must use the SYNC0 signal and mass of the PCI Express bus X2 of the PC card cifX 100EH-RE\CUBE at the host system and provide it at the host system via a well accessible 2-pin connector.

The PC card CIFX 100 EH-RE\CUBE provides the SYNC0 signal SYNC0. If at the SYNC connector (J1) the jumper is set on Pin1-Pin2, the SYNC0 signal is provided at pin B24 of the PCI Express bus X2. For further details on the pin assignment of the SYNC connector and on how to set the jumpers, refer to section *Pin Assignment SYNC Connector, J1 (CIFX 100EH)* on page 143. For the pin assignment of the PCI Express bus X2, refer to section *Pin Assignment for PCI Express Bus CIFX 100EH-RE\CUBE* on page 146.

The SYNC0 signal has LVTTTL level (3.3 V). A maximum load of 6 mA must not be exceeded.

You should keep the cable length for the sync signals below 50 mm and take into account EMC aspects.

## 4 Getting Started

### 4.1 Warnings

When installing, uninstalling or replacing the PC card cifX, obey to the following safety messages on **personal injury** respectively on **personal injury** that may occur together **with property damage**.



---

#### **⚠ WARNING**

#### **Lethal Electrical Shock caused by parts with more than 50V!**

HAZARDOUS VOLTAGE inside of the PC or of the connecting device.



- Strictly obey to all safety rules provided by the device's manufacturer in the documentation!
  - First disconnect the power plug of the PC or of the connecting device, before you open the cabinet.
  - Make sure, that the power supply is off at the PC or at the connecting device.
  - Open the PC cabinet and install or remove the PC card cifX only after disconnecting power.
- 

#### **⚠ WARNING**

#### **Communication Stop caused by Firmware or Configuration Download**

Initiating a firmware or configuration download process during bus operation will stop the communication and a subsequent plant stop may cause unpredictable and unexpected behavior of machines and plant components, possibly resulting in personal injury and damage to your equipment.

The firmware download overwrites the existing firmware. The communication stop may cause loss of device parameters and possible device damage may occur.

- Stop the application program, before you start the firmware or configuration download.
  - Make sure that all network devices are placed in a fail-safe condition.
- 

#### **⚠ WARNING**

#### **Mismatching System Configuration**

Mismatching system configuration loaded into the device could result in faulty data mapping in the application program and thus unexpected equipment operation may cause personal injury or damage of equipment.

- In the device use only a configuration suitable for the system.
-

Obey to the following **property damage** messages, when installing, uninstalling or replacing the PC card cifX.

---

**NOTICE****Exceeding permissible Supply Voltage**

Operating the PC card cifX with a supply voltage above of the specified range leads to device damage.

- Use only the permissible supply voltage to operate the PC card cifX.

---

**NOTICE****Exceeding permissible Signaling Voltage!**

All I/O signal pins at the PC card cifX tolerate only the specified signaling voltage! Operating the PC card cifX with a signaling voltage other than the specified signaling voltage may lead to severe damage to the PC card cifX!

- For the operation of the PC card cifX use only the specified signaling voltage.

---

For further information on the permissible supply and signaling voltage refer to section *Power Supply and Host Interface* on page 44.

---

**NOTICE****Electrostatically sensitive Devices**

- Adhere to the necessary safety precautions for components that are vulnerable with electrostatic discharge.
- To prevent damage to the PC and the PC card cifX, make sure, that the PC card cifX is grounded via the endplate and the PC and make sure, that you are discharged when you install/uninstall the PC card cifX.

---

**NOTICE****Power Disconnect while downloading Firmware or Configuration**

If the power supply to the PC or device is interrupted while the firmware or configuration is being downloaded, the download will be aborted, the firmware may be corrupted, the device parameters may be lost, and the device may be damaged.

- During firmware or configuration download process do not interrupt the power supply to the PC, or to the device and do not perform a reset to the device!

---

**NOTICE****Invalid Firmware**



Loading invalid firmware files could render your device unusable.

- Only proceed with a firmware version valid for your device.
-







## 4.2 Installation and Configuration PC Card cifX

The following table describes the steps for the software and hardware installation and for the configuration of a PC card cifX (Master and Slave) Real-Time Ethernet and fieldbus as it is typical for many cases. The Slave device can be configured using the corresponding Slave DTM in the configuration software **SYCON.net**. Alternatively, you can also use the simple Slave configuration tool **netX Configuration Tool**. The Master device can be configured using the corresponding Master DTM in the configuration software **SYCON.net**.

#	Step	Description	For detailed information see manual / section	Page
<b>1</b>	<b>Installing Driver and Software</b>			
1.1	Installing <b>cifX Device Driver</b>	<ul style="list-style-type: none"> <li>- Download the Communication Solutions DVD as ZIP file to the local hard disk of your PC.</li> <li>- Unzip the ZIP file.</li> <li>- Double-click the *.exe file in the root directory of the DVD to open the autostart menu.</li> <li>- Follow to the instructions of the installation wizard, to install the driver.</li> </ul>	<i>Refer to User Manual Software Installation for the PC cards cifX</i>	
1.2	Installing SYCON.net	For PC Cards cifX Master or Slave: Run the SYCON.net-Setup and follow to the instructions of the installation wizard.		
1.3	Installing <b>netX Configuration Tool</b> <i>Not usable for CC-Link IE Field cards</i>	For PC Cards cifX Slave: Start the <b>netX Configuration Tool setup</b> program to install the <b>netX Configuration Tool</b> .		
<b>2</b>	<b>Preparing Hardware Installation</b>			
2.1	Take precautions on Electrostatically sensitive Devices	 <p><b>Electrostatically sensitive Devices</b> Make sure, that the PC card cifX is grounded via the endplate and the PC and make sure, that you are discharged when you install/ uninstall the PC card cifX.</p>	<i>Electrostatically sensitive Devices</i>	32
2.2	Glue sticker on the front plate.	For CIFX 50-RE, CIFX 50E-RE, CIFX 70E-RE, CIFX 70E-RE\MR and CIFX 100EH-RE\CUBE	<i>Fix Front Plate Sticker</i>	96
2.2	Set the <b>Slot Number (Card ID)</b>	Value 0 or a value from 1 to 9	<i>Rotary Switch for Slot Number (Card ID)</i>	141
<b>3</b>	<b>Hardware Installation</b>	Installing cifX. Take required safety precautions.	<i>Hardware Installation and Uninstalling</i>	95
3.1	Take safety precautions	 <p><b>Lethal Electrical Shock caused by parts with more than 50V!</b> Disconnect the power plug of the PC or of the connecting device. Make sure, that the power supply is off at the PC or at the connecting device.</p>	<i>Electrical Shock Hazard</i>	29
3.2	Open cabinet	Now open the cabinet of the PC or of the connecting device.	<i>Installing PC Card cifX PCI, PCIe, Low Profile PCIe</i>	99



#	Step	Description	For detailed information see manual / section	Page
		<p>Note for PC Cards CIFX 50E-CCIES and CIFX 70E-CCIES:</p>  <p><b>Important!</b> For PC cards CIFX 50E-CCIES or CIFX 70E-CCIES only use CC-Link IE Field Slave firmware. Use CC-Link IE Field Slave firmware only with PC cards CIFX 50E-CCIES or CIFX 70E-CCIES.</p>		
<b>7</b>	<b>Configuring Slave using SYCON.net</b>	<b>Download Firmware and Configuration</b> Use the corresponding Slave DTM in the configuration software <b>SYCON.net</b> .		
7.1	Firmware Download	<ul style="list-style-type: none"> <li>- Start configuration software <b>SYCON.net</b>,</li> <li>- Create new project /Open existing project,</li> <li>- Insert Slave into configuration,</li> <li>- Select driver and assign device.</li> <li>- Select and download the firmware.</li> </ul>	<p>See corresponding user manual</p> <p>Device Names in SYCON.net</p>	55
	<i>Firmware Slave:</i>	<p>CC-Link IE Field Basic Slave, CC-Link IE Field Slave*, EtherCAT Slave, EtherNet/IP Adapter, Open-Modbus/TCP, POWERLINK-Controlled-Node/Slave, PROFINET IO Device, Sercos Slave, VARAN Client,</p> <p>PROFIBUS DP Slave, PROFIBUS MPI Device, CANopen Slave, DeviceNet Slave, CC-Link Slave</p>  <p><b>Important!</b> *Use the CC-Link IE Field Slave firmware only together with the PC cards CIFX 50E-CCIES or CIFX 70E-CCIES and do not use any other firmware for these cards.</p>		
7.2	Configuration cifX (Slave)	-Configure the PC card cifX (Slave).		
7.3	Download Configuration	- Download the configuration to the PC card cifX (Slave)		
<b>8</b>	<b>OR Configuring Slave using netX Configuration Tool</b>	<b>Download Firmware and Configuration</b> (not valid for CC-Link IE Field Slave)		
8.1	Downloading Firmware and Configuration (Slave)	<p>If SYCON.net was already used on the PC, stop the ODMV3 service. Therefore, select <b>Service &gt; Stop</b> from the context menu of the ODMV3 system tray icon.</p>  <p>The ODMV3 system tray icon changes to <b>ODMV3 Service stopped</b>.</p> 	<p>Requirements for Operation of the PC Card cifX</p>	45

#	Step	Description	For detailed information see manual / section	Page
		In the <b>netX Configuration Tool</b> : <ul style="list-style-type: none"> <li>- select the Firmware protocol,</li> <li>- Set the PC card cifX (Slave) parameters.</li> <li>- Select <b>Apply</b>.</li> </ul> The selected firmware and the configuration are downloaded to the replacement card cifX. The configuration is saved to the hard disk of the PC.	<i>See Operating Instruction Manual netX Configuration Tool for cifX, comX and netJACK</i>	
<b>9</b>	<b>Configuring Master using SYCON.net</b>	<b>Download Firmware and Configuration</b> Use the corresponding Master DTM in the configuration software <b>SYCON.net</b> .		
9.1	Firmware Download  <i>Firmware Master:</i>	<ul style="list-style-type: none"> <li>- Start configuration software <b>SYCON.net</b>,</li> <li>- Create new project /Open existing project,</li> <li>- Insert Master into configuration,</li> <li>- Select driver and assign device.</li> <li>- Select and download the firmware.</li> </ul> EtherCAT Master, PROFIBUS DP Master, EtherNet/IP Scanner, CANopen Master, PROFINET IO Controller, DeviceNet Master, AS-Interface Master	<i>See corresponding user manual</i>  <i>Device Names in SYCON.net</i>	55
9.2	Configuration cifX (Master)	- Configure the PC card cifX (Master).	<i>Notes for the Configuration of the Master Device</i>	53
9.3	Download Configuration	- Download the configuration to the PC card cifX (Master).		
<b>10</b>	<b>Slave Diagnosis by SYCON.net (Slave and Master)</b>	<b>Diagnosis, I/O Data</b> Use the corresponding Slave or Master DTM in the configuration software <b>SYCON.net</b> .		
10.1	Diagnostic	<ul style="list-style-type: none"> <li>- Rightclick on the device symbol.</li> <li>- Select context menu entry <b>Diagnosis</b>,</li> <li>- then select <b>Diagnosis &gt; General</b> or <b>Firmware Diagnosis</b>,</li> <li>- or select <b>Diagnosis &gt; Extended Diagnosis</b>.</li> </ul>	<i>See corresponding user manual</i>	
10.2	I/O Monitor	<ul style="list-style-type: none"> <li>- Rightclick on device symbol.</li> <li>- Select context menu entry <b>Diagnosis</b>,</li> <li>- then <b>Tools &gt; IO Monitor</b>.</li> <li>-Check the input or output data.</li> </ul>		
<b>11</b>	<b>OR Slave Diagnosis by netX Configuration Tool (only Slave)</b>	<b>Diagnosis</b>		
11.1	Configuration Steps cifX (Slave)	If SYCON.net was already used on the PC, stop the ODMV3 service. Therefore, select <b>Service &gt; Stop</b> from the context menu of the ODMV3 system tray icon.  In the <b>netX Configuration Tool</b> : <ul style="list-style-type: none"> <li>- In the navigation area click on <b>Diagnostic</b>,</li> <li>- click in the <b>Diagnostic</b> pane to <b>Start</b>, to start the communication to the Master device and to run the diagnosis.</li> <li>- click on <b>Extended</b>, to run the extended diagnosis.</li> </ul>	<i>See Operating Instruction Manual netX Configuration Tool for cifX, comX and netJACK</i>	

Table 28: Steps for the Software and Hardware Installation, the Configuration and for the Diagnosis of a PC Card cifX (Master and Slave)

### 4.3 Note on Exchange Service (Replacement Case)

For the exchange service (replacement case) of a PC card cifX (Master and Slave) obey to the following note.



**Important!** For the replacement card cifX with **Rotary Switch Slot Number (Card ID)** set the same **Slot Number (Card ID)** as at the previous PC card cifX (see section *Rotary Switch for Slot Number (Card ID)* on page 141).

For PC cards cifX without **Rotary Switch Slot Number (Card ID)** in terms of a device exchange service (replacement case) you must manually download the same firmware and configuration into the replacement card cifX, as into the preceding cifX.

### 4.4 Notes for the Configuration of the Master Device

To configure the Master, a device description file is required. Note the following notes for the configuration of the Master Device:

System	Note
<i>CC-Link IE Field Basic Slave</i>	To configure the Master, a CSPP file (device description file) is required. The settings in the used Master must comply with the settings in the Slave to establish communication. Important parameters are: Slave Station Address, Input and output data, , vendor code, model type, occupied stations.
<i>CC-Link IE Field Slave</i>	To configure the Master, a CSPP file (device description file) is required. The settings in the used Master must comply with the settings in the Slave to establish communication. Important parameters are: Slave Station Address, Input and output data, vendor code, model code.
<i>EtherCAT Slave</i>	To configure the Master, an XML file (device description file) is required. The settings in the used Master must comply with the settings in the Slave to establish communication. Important parameters are: Vendor ID, Product Code, Serial Number, Revision Number, Output and Input Data Bytes.
<i>EtherCAT Slave</i>	If the XML file <i>Hilscher CIFX RE ECS V2.2.X.xml</i> is use/updated, the firmware with the version <b>2.2.x</b> must be use/updated.  The loadable firmware supports for the number of cyclic input data and for cyclic output data in total up to 400 bytes. If more than 200 bytes for input data or for output data should be exchanged via EtherCAT, then a customer specific XML file is necessary. Additionally the following formular applies: $(\text{number of input bytes} + 3)/4 + (\text{number of output bytes} + 3)/4$ must be less or equal to 100.
<i>EtherNet/IP Adapter</i>	To configure the Scanner/Master, an EDS file (device description file) is required. The settings in the used Scanner/Master must comply with the settings in the Adapter/Slave to establish communication. Important parameters are: Input, Output Data Bytes, Vendor ID, Product Type, Product Code, Major Rev, Minor Rev, IP Address and Netmask.
<i>POWERLINK- Controlled- Node/Slave</i>	To configure the Managing Node/Master, an XDD file (device description file) is required. The settings in the used Managing Node/Master must comply with the settings in the Controlled Node/Slave, to establish communication. Important parameters are: Vendor ID, Product Code, Serial Number, Revision Number, Node ID, Output and Input length.
<i>PROFINET IO Device</i>	To configure the Controller, a GSDML file (device description file) is required. The settings in the used Controller must comply with the settings in the Device to establish communication. Important parameters are: Station Name, Vendor ID, Device ID, Input and Output Data Bytes.  Under Name of Station, the name must be typed which was also used in the configuration file of the master of this device. If no name chosen freely is used in the configuration file, then the name from the GSDML file is used.

System	Note
<i>Sercos Slave</i>	The Sercos Master uses the Sercos address to communicate with the slave. Some Masters will verify Device ID, Vendor Code, Input Data Size and Output Data Size and will do further communication to the Slave only if all these values match. Therefore the Master reads these parameters from the Slave and compares them with the configuration stored in the Master.  The parameters Device ID, Vendor Code, Input Data Size and Output Data Size are part of the SDDML device description file. If for the configuration of the Sercos Master SDDML files are used and a default value of one of these parameters was changed, then a SDDML file must be created in the configuration software via Export SDDML and then used in the configuration of the Sercos Master.
<i>PROFIBUS DP Slave</i>	To configure the Master, a GSD file (device description file) is required. The settings in the used Master must comply with the settings in the Slave to establish communication. Important parameters are: Station Address, Ident Number, Baudrate and Config Data (the configuration data for the output and input length).
<i>CANopen Slave</i>	To configure the Master, an EDS file (device description file) is required. The settings in the used Master must comply with the settings in the Slave to establish communication. Important parameters are: Node Address and Baudrate.
<i>DeviceNet Slave</i>	To configure the Master, an EDS file (device description file) is required. The settings in the used Master must comply with the settings in the Slave to establish communication. Important parameters are: MAC ID, Baudrate, Produced Size, Consumed Size, Vendor ID, Product Type, Product Code, Major Rev, Minor Rev.
<i>CC-Link Slave</i>	To configure the Master, a CSP file (device description file) is required. The settings in the used Master must comply with the settings in the Slave to establish communication. Important parameters are: Slave Station Address, Baudrate, Station Type and Vendor Code.

*Table 29: Notes for the Configuration of the Master Device*



Further information to the device description files you find under section on *Device Description Files PC Cards cifX* page 21.

## 4.5 Device Names in SYCON.net

The following table contains the device names displayed for the single communication protocols in the configuration software SYCON.net.

The table shows the PC card cifX and which protocol can be used. Furthermore, the table shows, for which protocol which device must be selected from the device catalog to configure the PC card cifX with SYCON.net.

PC Cards cifX	Protocol	DTM Specific Group	Device Name in SYCON.net
CIFX 50-RE, CIFX 50E-RE, CIFX 50E-RE\ET CIFX 70E-RE, CIFX 70E-RE\MR, CIFX 100EH-RE\CUBE	CC-Link IE Field Basic Slave	Gateway/Stand-Alone Slave	CiFX RE/CCIBS
	EtherCAT Master	Master	CIFX RE/ECM
	EtherCAT Slave	Gateway/Stand-Alone Slave	CIFX RE/ECS
	EtherNet/IP Scanner (Master)	Master	CIFX RE/EIM
	EtherNet/IP Adapter (Slave)	Gateway/Stand-Alone Slave	CIFX RE/EIS
	Open-Modbus/TCP	Gateway/Stand-Alone Slave	CIFX RE/OMB
	POWERLINK-Controlled-Node/Slave	Gateway/Stand-Alone Slave	CIFX RE/PLS
	PROFINET IO-Controller	Master	CIFX RE/PNM
	PROFINET IO-Device	Gateway/Stand-Alone Slave	CIFX RE/PNS
	Sercos Master	Master	CIFX RE/S3M
	Sercos Slave	Gateway/Stand-Alone Slave	CIFX RE/S3S
VARAN Client (Slave)	Gateway/Stand-Alone Slave	CIFX RE/VRS	
CIFX 50E-CCIES, CIFX 70E-CCIES	CC-Link IE Field Slave	Gateway/Stand-Alone Slave	CiFX RE/CCIES
CIFX 50-DP, CIFX 50E-DP, CIFX 70E-DP, CIFX 70E-DP\MR	PROFIBUS DP Master	Master	CIFX DP/DPM
	PROFIBUS DP Slave	Gateway/Stand-Alone Slave	CIFX DP/DPS
	PROFIBUS MPI Device	Gateway/Stand-Alone Slave	CIFX DP/MPI
CIFX 50-2DP, CIFX 50E-2DP	PROFIBUS DP Master	Master	2*CIFX DP/DPM <i>for each PROFIBUS DP channel one CIFX DP/DPM</i>
	PROFIBUS DP Slave	Gateway/Stand-Alone Slave	2*CIFX DP/DPS <i>for each PROFIBUS DP channel one CIFX DP/DPS</i>
CIFX 50-2DP\CO, CIFX 50E-2DP\CO	PROFIBUS DP Master, CANopen Master	Master	1*CIFX DP/DPM, <i>for PROFIBUS DP channel one CIFX DP/DPM</i> 1*CIFX CO/COM, <i>for CANopen channel one CIFX CO/COM</i>
	PROFIBUS DP Slave, CANopen Slave	Gateway/Stand-Alone Slave	1*CIFX DP/DPS, <i>for PROFIBUS DP channel one CIFX DP/DPS</i> 1*CIFX CO/COS, <i>for CANopen channel one CIFX CO/COS</i>
CIFX 50-2DP\DN, CIFX 50E-2DP\DN	PROFIBUS DP Master, DeviceNet Master	Master	1*CIFX DP/DPM, <i>for PROFIBUS DP channel one CIFX DP/DPM</i> 1*CIFX DN/DNM, <i>for DeviceNet channel one CIFX DN/DNM</i>

PC Cards cifX	Protocol	DTM Specific Group	Device Name in SYCON.net
	PROFIBUS DP Slave, DeviceNet Slave	Gateway/Stand-Alone Slave	1*CIFX DP/DPS, <i>for PROFIBUS DP channel one CIFX DP/DPS</i> 1*CIFX DN/DNS, <i>for DeviceNet channel one CIFX DN/DNS</i>
CIFX 50-CO CIFX 50E-CO, CIFX 70E-CO, CIFX 70E-COMR	CANopen Master	Master	CIFX CO/COM
	CANopen Slave	Gateway/Stand-Alone Slave	CIFX CO/COS
CIFX 50-2CO, CIFX 50E-2CO	CANopen Master	Master	2* CIFX CO/COM <i>for each CANopen channel one CIFX CO/COM</i>
	CANopen Master, CANopen Slave	Master, Gateway/ Stand-Alone Slave	1* CIFX CO/COM, <i>for 1 CANopen channel one CIFX CO/COM</i> 1* CIFX CO/COS, <i>for 1 CANopen channel one CIFX CO/COS</i>
	CANopen Slave	Gateway/Stand-Alone Slave	2*CIFX CO/COS <i>for each CANopen channel one CIFX CO/COS</i>
CIFX 50-CO\DN, CIFX 50E-2CO\DN	CANopen Master, DeviceNet Master	Master	1* CIFX CO/COM, <i>for CANopen channel one CIFX CO/COM</i> 1*CIFX DN/DNM, <i>for DeviceNet channel one CIFX DN/DNM</i>
	CANopen Slave, DeviceNet Slave	Gateway/Stand-Alone Slave	1* CIFX CO/COS, <i>for CANopen channel one CIFX CO/COS</i> 1* CIFX DN/DNS, <i>for DeviceNet channel one CIFX DN/DNS</i>
CIFX 50-DN CIFX 50E-DN, CIFX 70E-DN, CIFX 70E-DN\MR	DeviceNet Master	Master	CIFX DN/DNM
	DeviceNet Slave	Gateway/Stand-Alone Slave	CIFX DN/DNS
CIFX 50-2DN, CIFX 50E-2DN	DeviceNet Master	Master	2* CIFX DN/DNM <i>for each DeviceNet channel one CIFX DN/DNM</i>
	DeviceNet Slave	Gateway/Stand-Alone Slave	2* CIFX DN/DNS <i>for each DeviceNet channel one CIFX DN/DNS</i>
CIFX 50-2ASM, CIFX 50E-2ASM	AS-Interface Master	Master	CIFX AS/ASM <i>for each AS-Interface channel one CIFX AS/ASM</i>
CIFX 50-CC CIFX 50E-CC	CC-Link Slave	Gateway/Stand-Alone Slave	CIFX CC/CCS

Table 30: Device Names in SYCON.net by Communication Protocol



## 4.6 Update for Firmware, Driver and Software



**Note:** As a pre-requirement for the software update the project files, the configuration files and firmware files are to be saved.

At existing hardware installation the firmware, the driver and the configuration software must be updated according to the versions given in section *Notes on Hardware, Firmware, Software and Driver Versions* on page 10. The following graphic gives an overview:

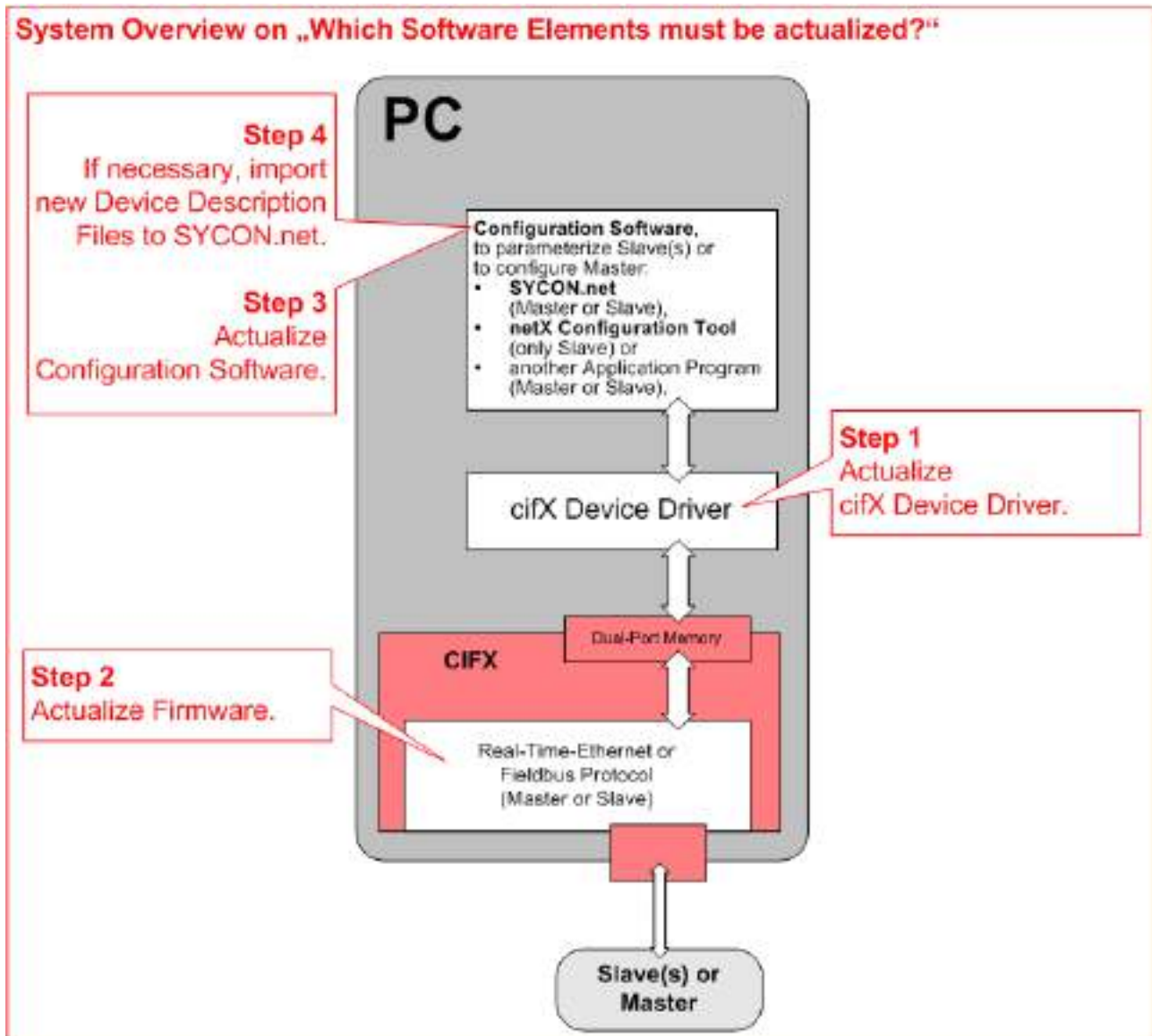

Figure 1: System Overview cifX to update Firmware, Driver and Software



Note the specific details for devices with **Rotary Switch Slot Number (Card ID)** in the section *The Function „Slot Number (Card ID)“* on page 39 or **DMA Mode** in section *The Function „DMA Mode“* on page 41.

# 5 Device Drawings

## 5.1 PC Cards cifX PCI and PCI Express

### 5.1.1 CIFX 50-RE, CIFX 50E-RE, CIFX 50E-RE\ET

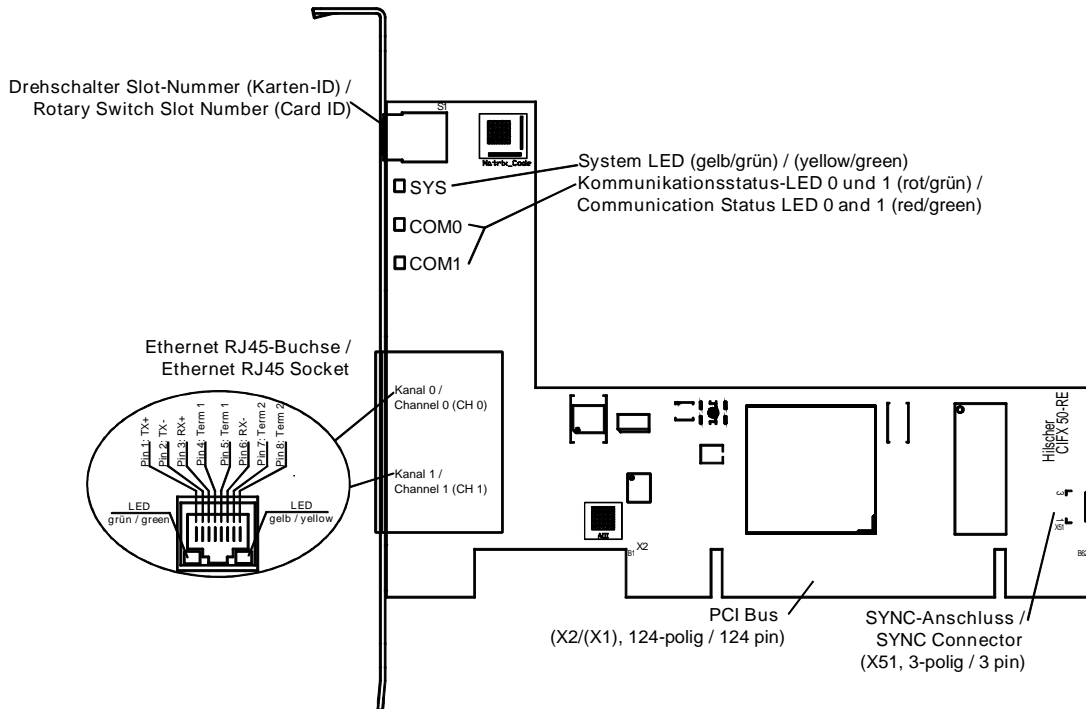

Figure 2: CIFX 50-RE\* (from hardware rev. 3)

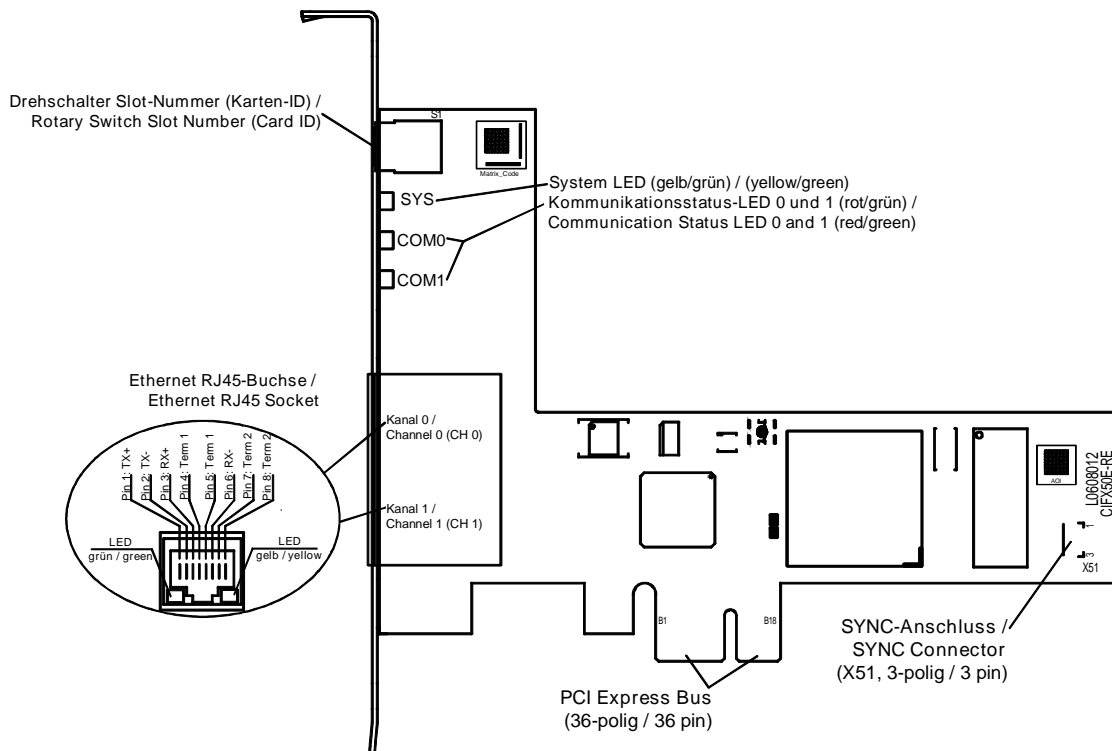

Figure 3: CIFX 50E-RE\* (from hardware rev. 4), CIFX 50E-RE\ET\* (from hardware rev. 1)



**Note:** \*Device supports Auto Crossover Function. Note also: With loaded EtherCAT Master firmware only the RJ45 channel 0 can be used, channel 1 is deactivated. Beginning with EtherCAT Master firmware V3 channel 1 can be reactivated if redundancy is activated. For Open Modbus/TCP with V2.3.4.0 and higher both RJ45 channels can be used.



For the **SYNC** pin assignment of the SYNC Connector refer to section *Pin Assignment SYNC Connector, X51 (CIFX 50 50E 70E)* on page 143. Device drawings of earlier device revisions without rotary switch slot number (card ID) are included in the user manual for PC cards cifX Real-Time Ethernet up to manual rev. 32.

The figure below shows the front plate of the PC cards CIFX 50-RE, CIFX 50E-RE or CIFX 50E-RE\ET:

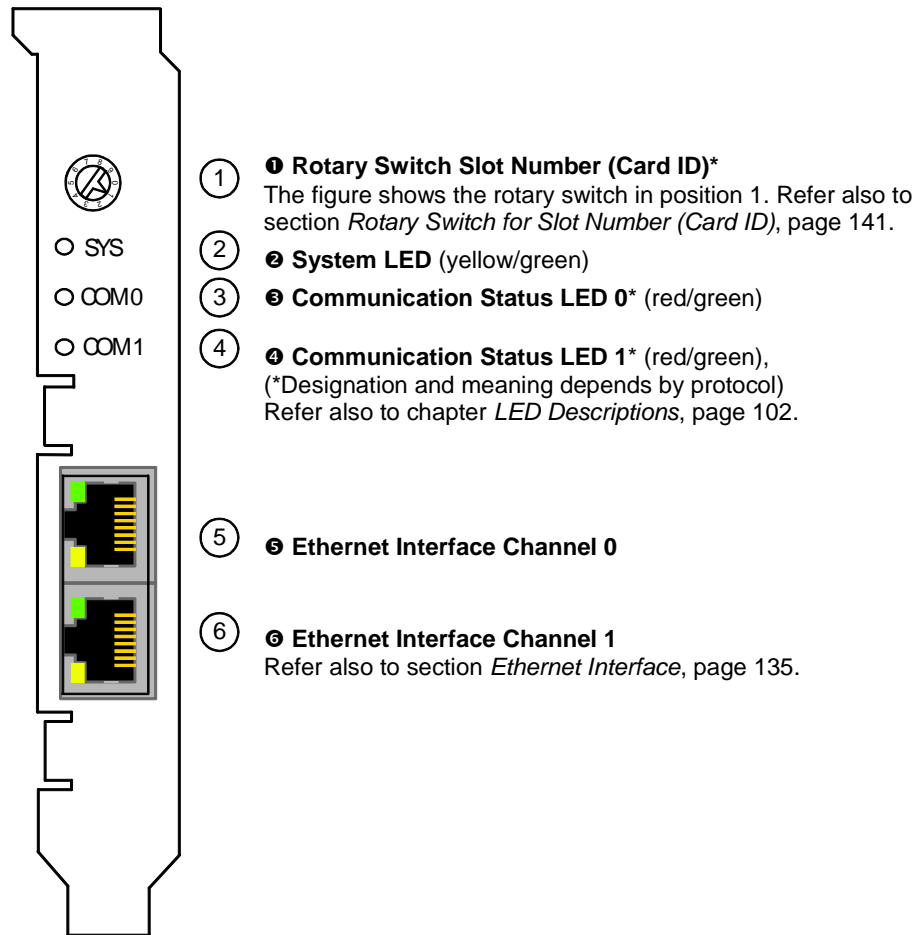

Figure 4: Front Plate for CIFX 50-RE, CIFX 50E-RE or CIFX 50E-RE\ET

\*From hardware revision 3 (for CIFX 50-RE), 4 (for CIFX 50E-RE) or 1 (for CIFX 50E-RE\ET) on, the **Rotary Switch Slot Number (Card ID)** is provided.

### 5.1.2 CIFX 50E-CCIES

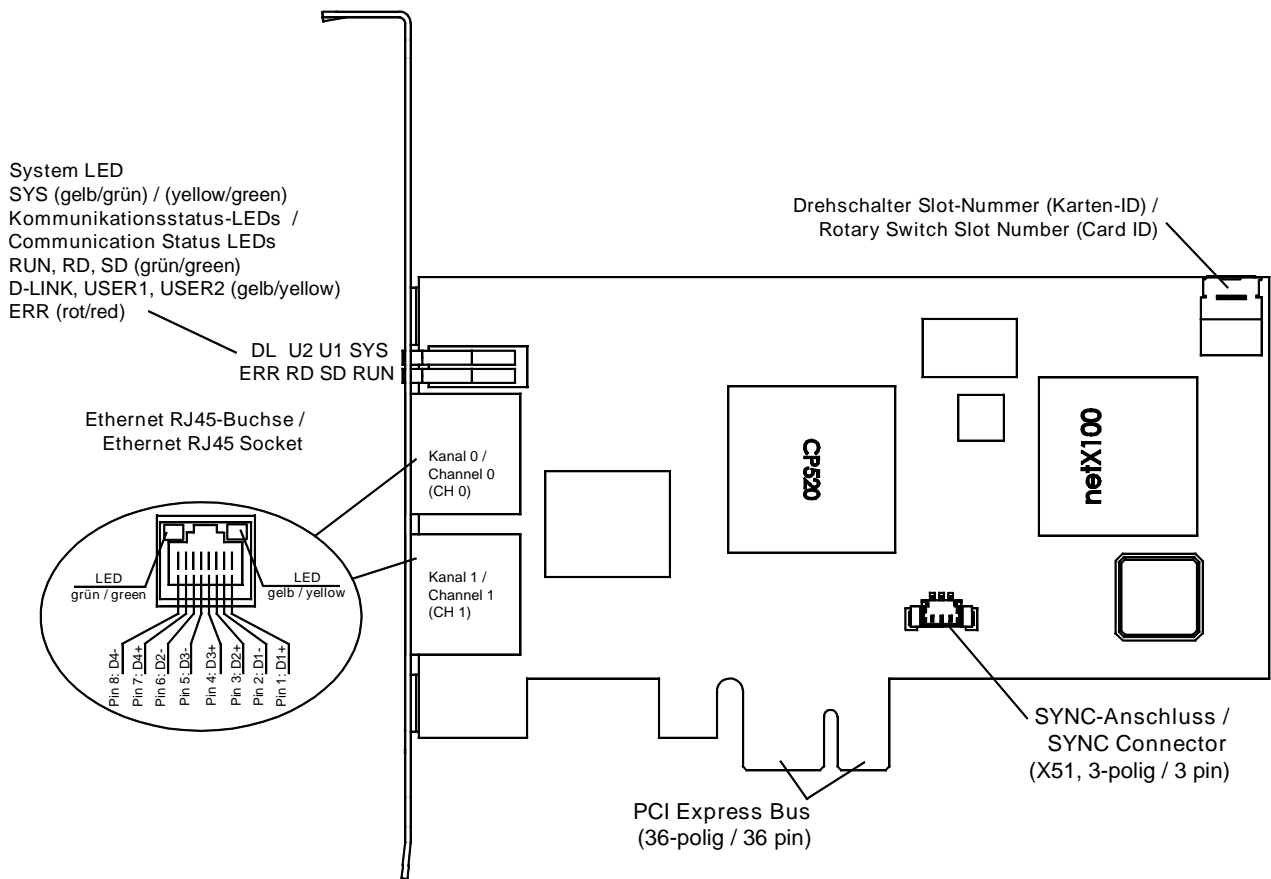

Figure 5: CIFX 50E-CCIES\* (Hardware revision 1)



**Note:** \*Device supports Auto Crossover Function.



For details about the **Rotary Switch Slot Number (Card ID)** refer to section *Rotary Switch for Slot Number (Card ID)*, page 141.

For the **SYNC** pin assignment of the SYNC Connector refer to section *Pin Assignment SYNC Connector, X51 (CIFX 50 50E 70E)* on page 143.

The figure below shows the front plate of the PC card CIFX 50E-CCIES:

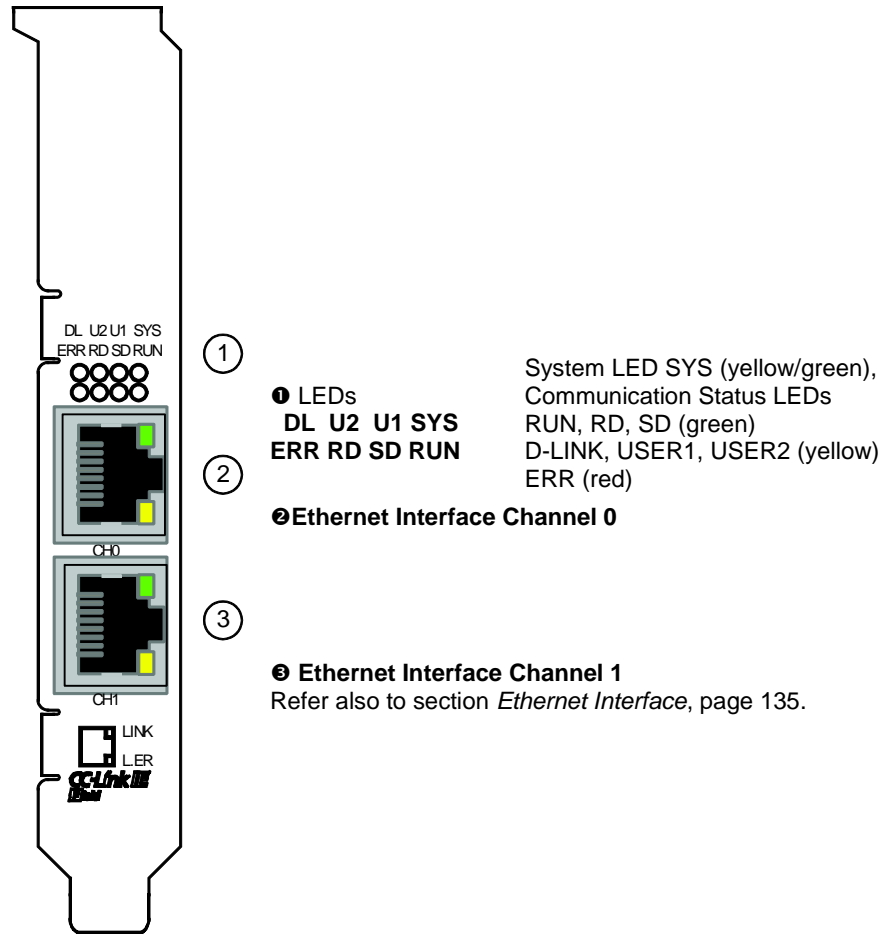

Figure 6: Front Plate for CIFX 50E-CCIES

### 5.1.3 CIFX 50-DP, CIFX 50E-DP

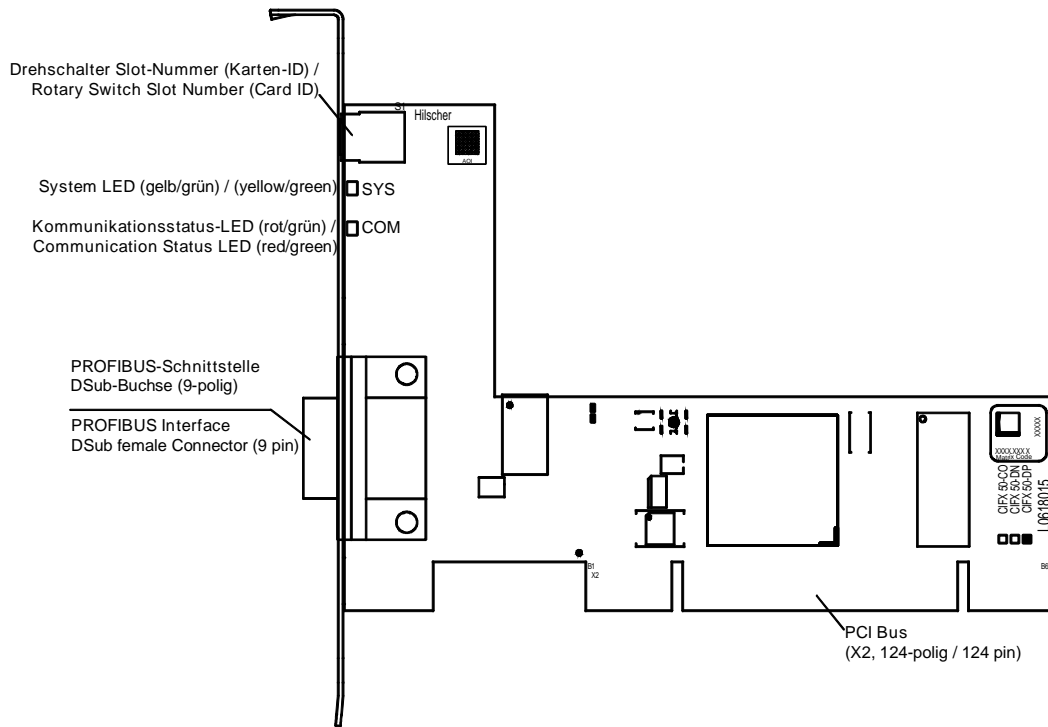

Figure 7: CIFX 50-DP (hardware revision 5)\*

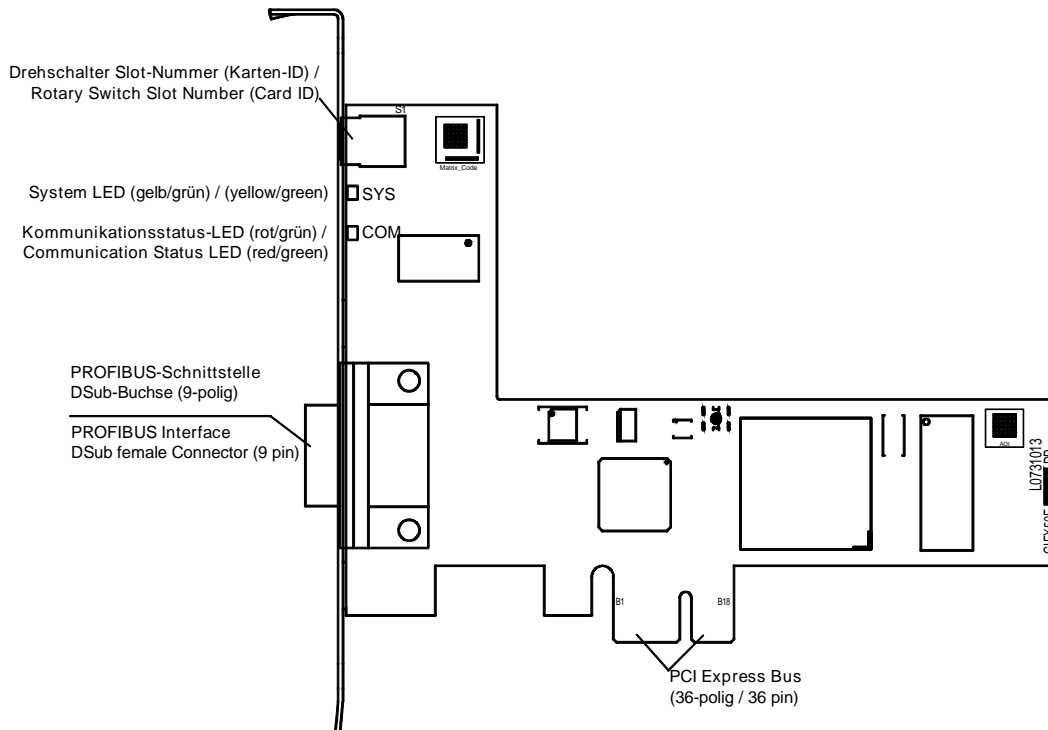

Figure 8: CIFX 50E-DP (hardware revision 5)\*



\*Device drawings of earlier device revisions without rotary switch slot number (card ID) or with two COM LEDs are included in the user manual for PC cards cifX fieldbus up to manual rev. 23.

The figure below shows the front plate of the PC cards  
 CIFX 50-DP or CIFX 50E-DP:

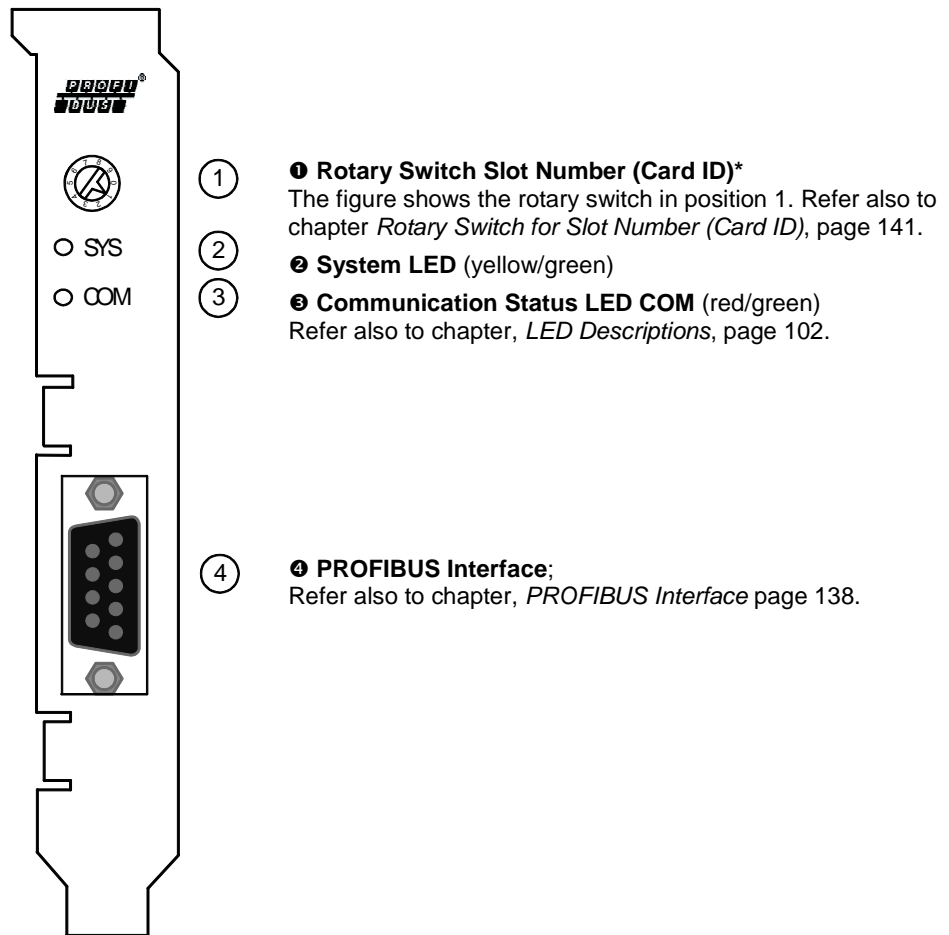

Figure 9: Front Plate CIFX 50-DP or CIFX 50E-DP

\*From hardware revision 5 (for CIFX 50-DP or CIFX 50E-DP) on, the **Rotary Switch Slot Number (Card ID)** is provided.

### 5.1.4 CIFS 50-2DP, CIFS 50E-2DP

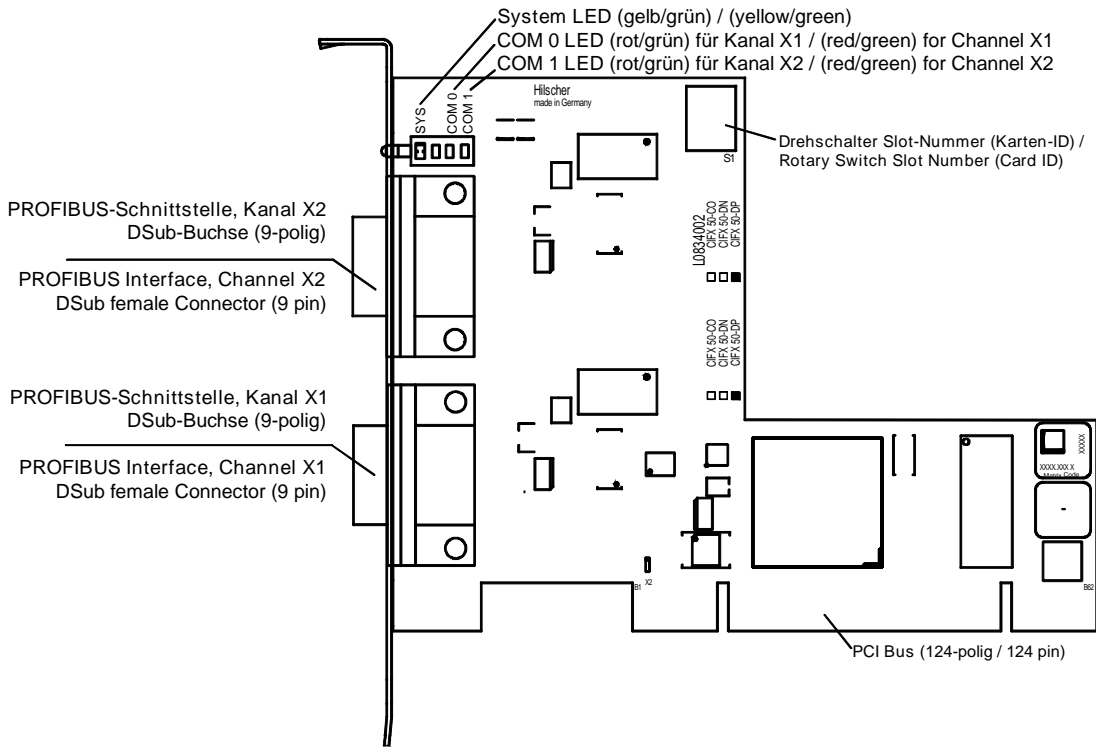

Figure 10: CIFS 50-2DP (Hardware Revision 3)

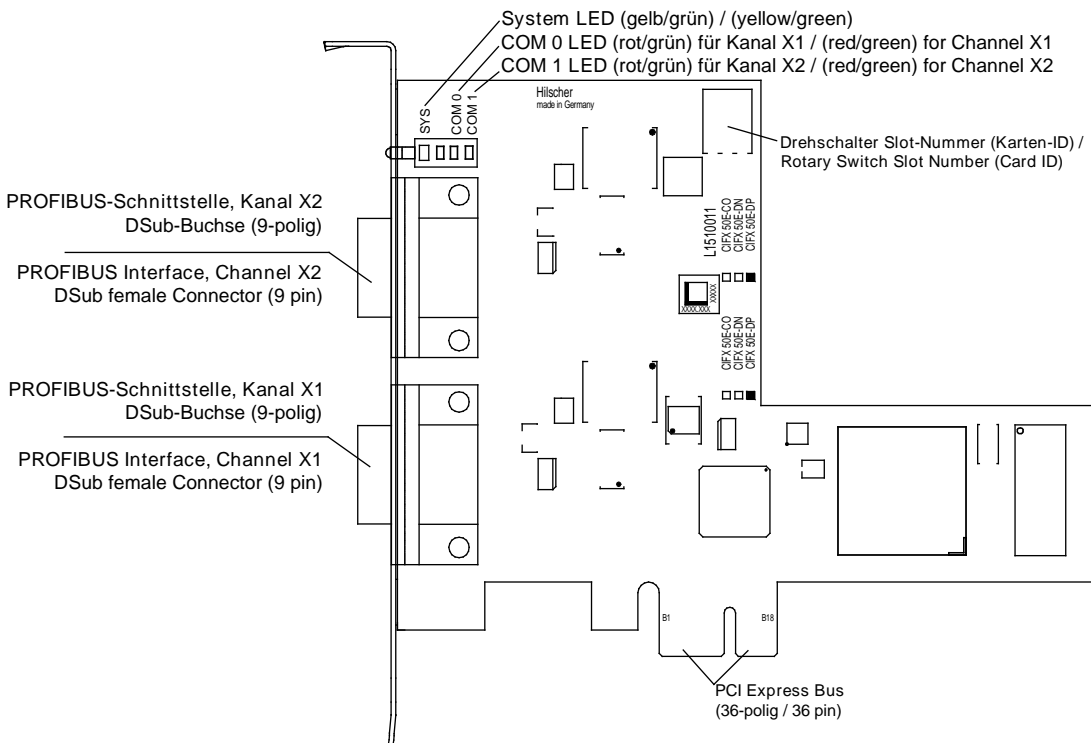

Figure 11: CIFS 50E-2DP (Hardware Revision 1)

A Device drawing of the earlier device revision without rotary switch slot number (card ID) is included in the user manual rev. 37.



The figure below shows the front plate of the PC cards  
 CIFX 50-2DP, CIFX 50E-2DP:

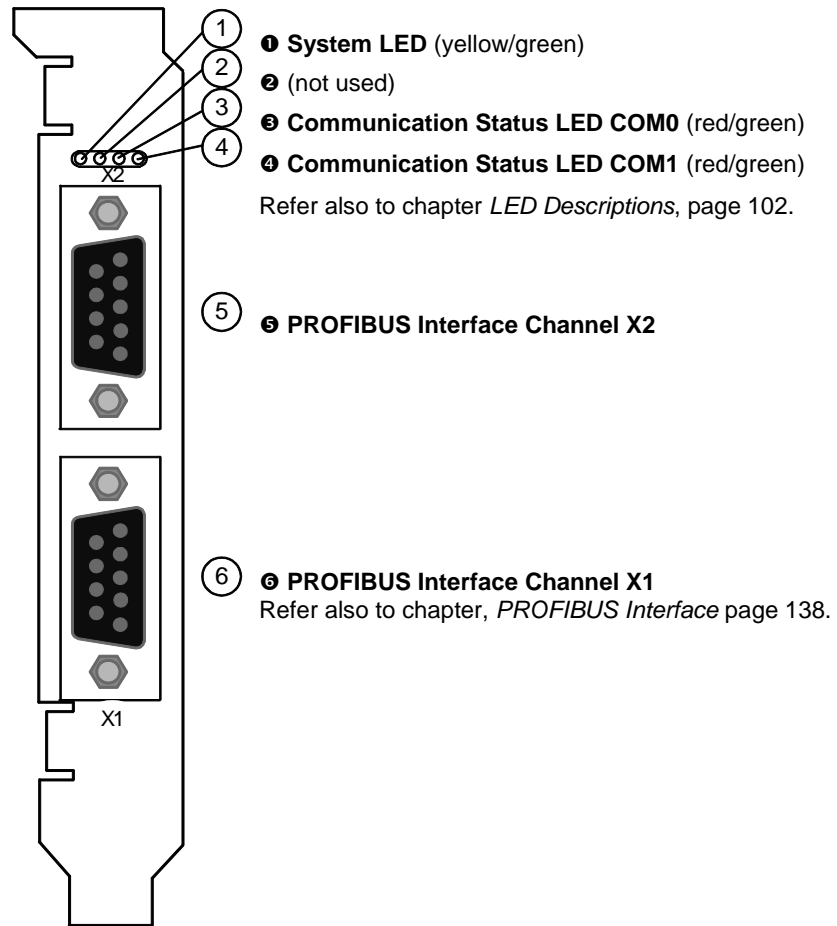

Figure 12: Front Plate CIFX 50-2DP, CIFX 50E-2DP

### 5.1.5 CIFX 50-2DP\CO, CIFX 50E-2DP\CO

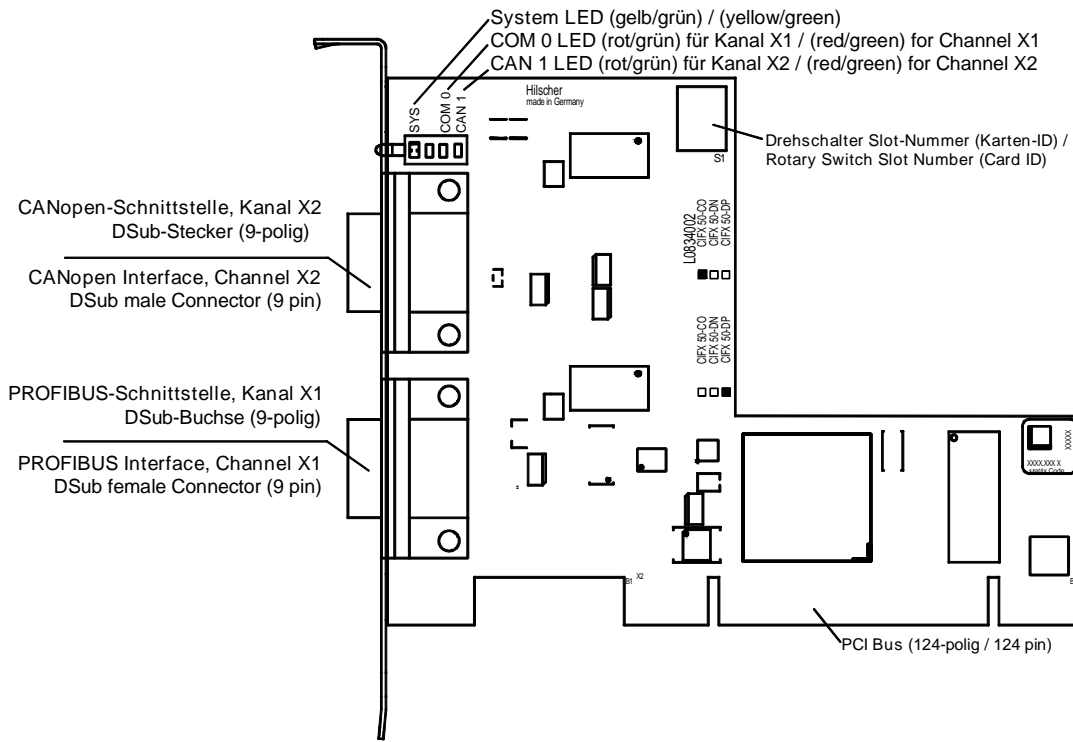

Figure 13: CIFX 50-2DP\CO (Hardware Revision 2)

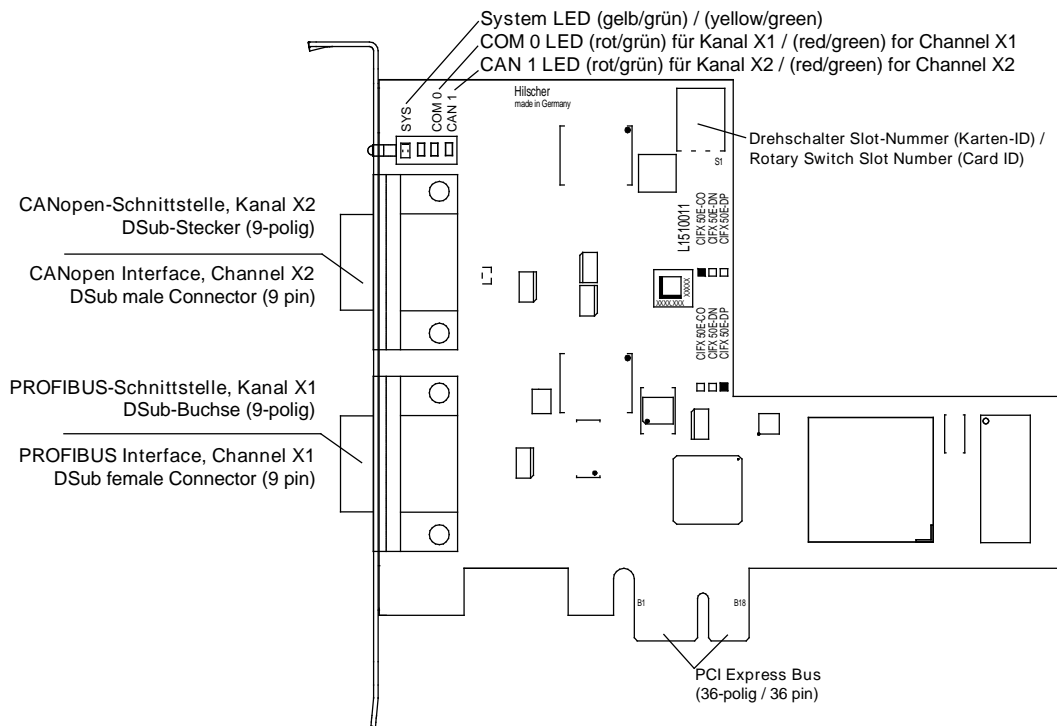

Figure 14: CIFX 50E-2DP\CO (Hardware Revision 1)

The figure below shows the front plate of the PC cards  
 CIFX 50-2DP\CO, CIFX 50E-2DP\CO:

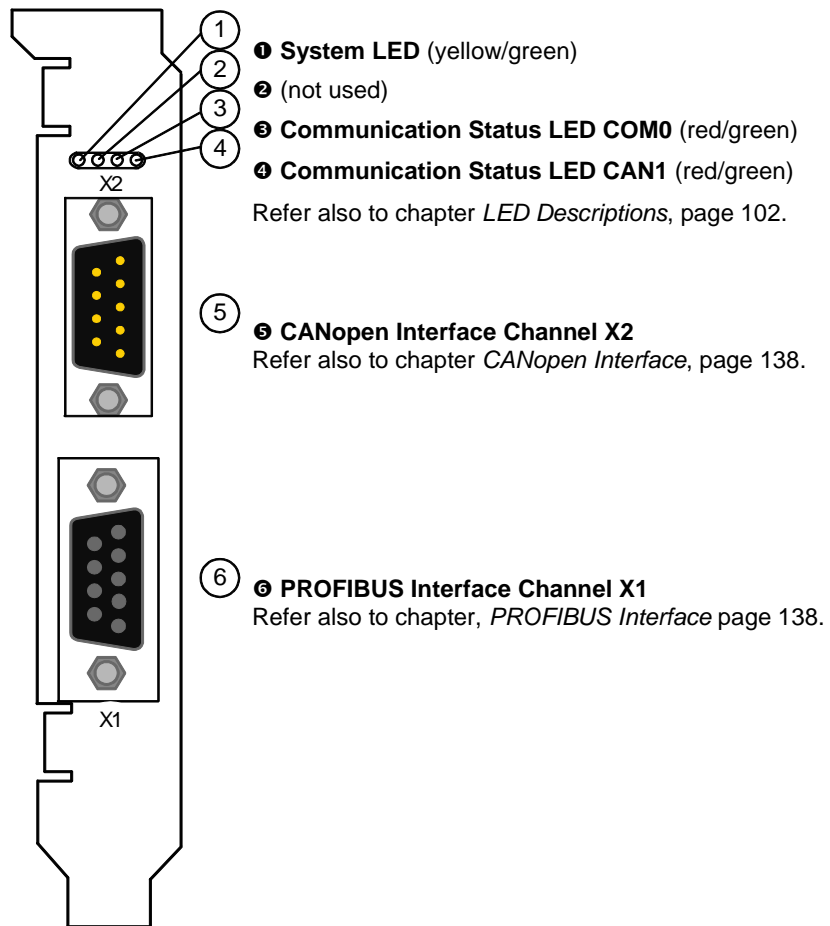

Figure 15: Front Plate CIFX 50-2DP\CO, CIFX 50E-2DP\CO

### 5.1.6 CIFX 50-2DP\DN, CIFX 50E-2DP\DN

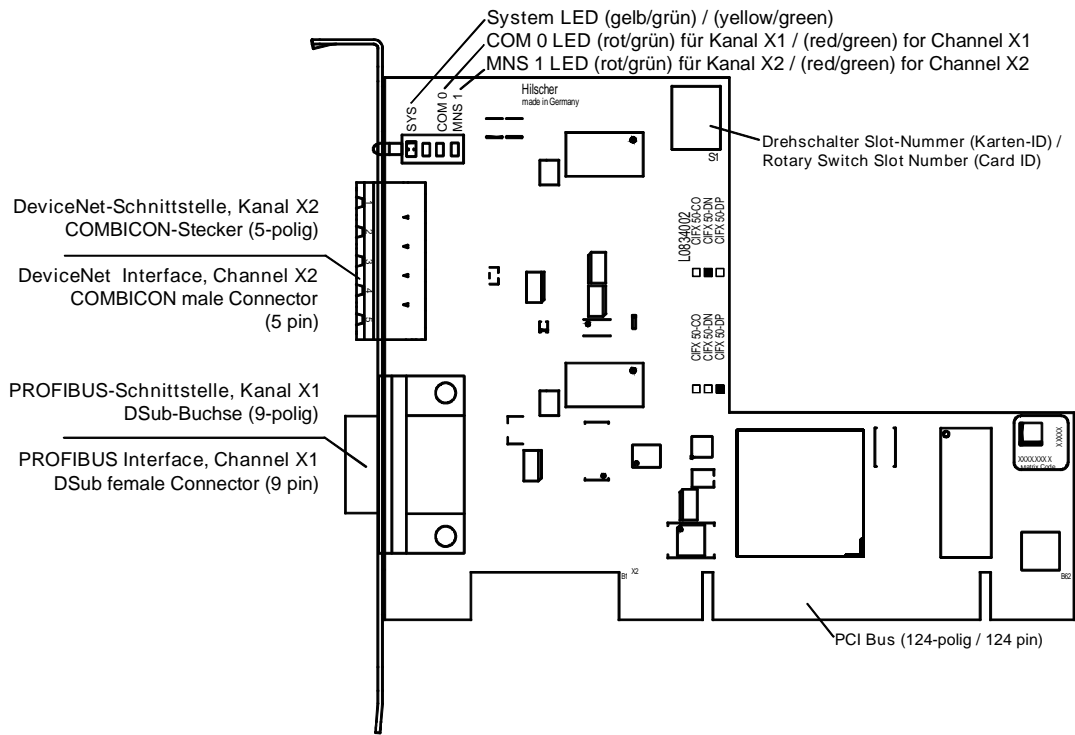

Figure 16: CIFX 50-2DP\DN (Hardware Revision 1)

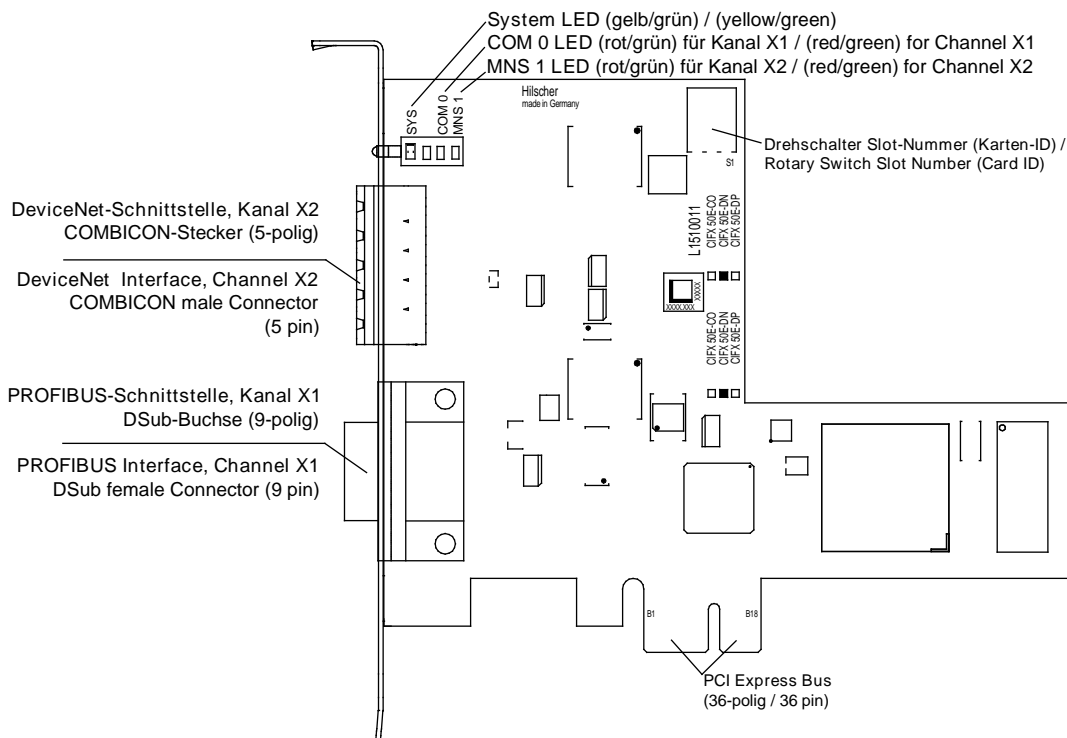

Figure 17: CIFX 50E-2DP\DN (Hardware Revision 1)

The figure below shows the front plate of the PC cards  
 CIFX 50-2DP\DN, CIFX 50E-2DP\DN:

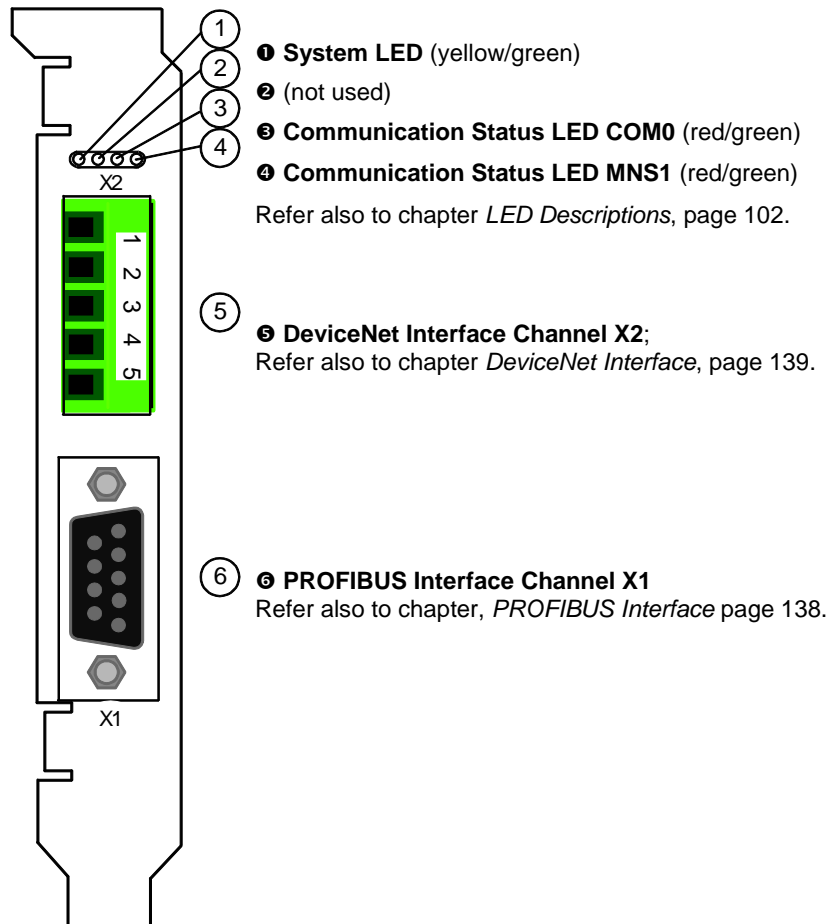

Figure 18: Front Plate CIFX 50-2DP\DN, CIFX 50E-2DP\DN

### 5.1.7 CIFX 50-CO, CIFX 50E-CO

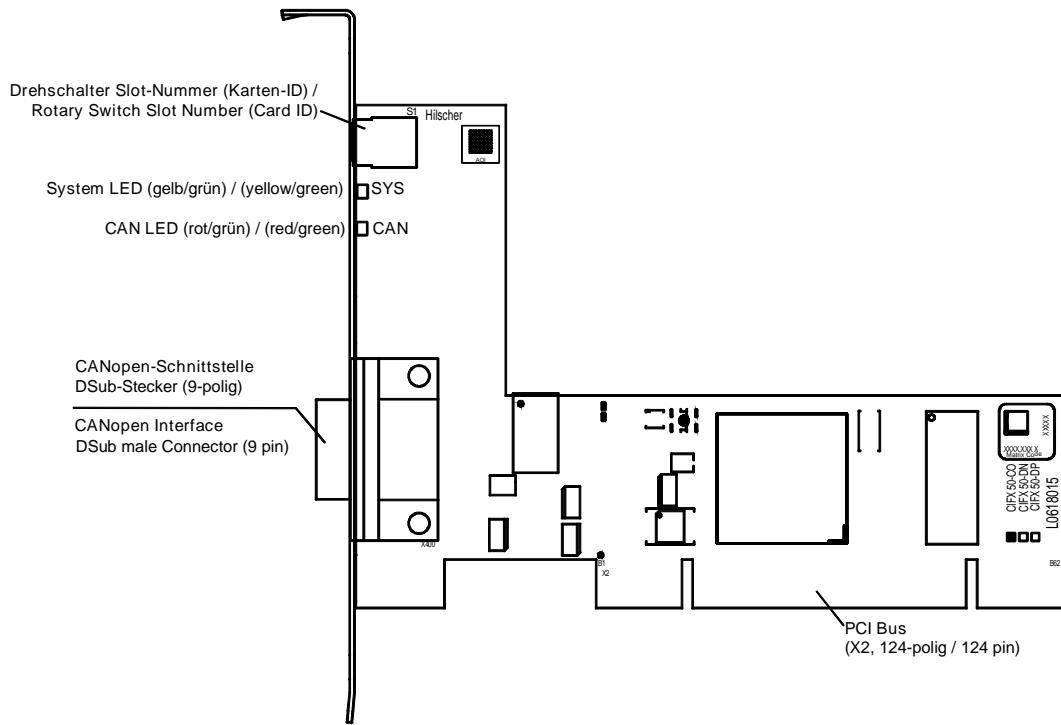

Figure 19: CIFX 50-CO (hardware revision 5)

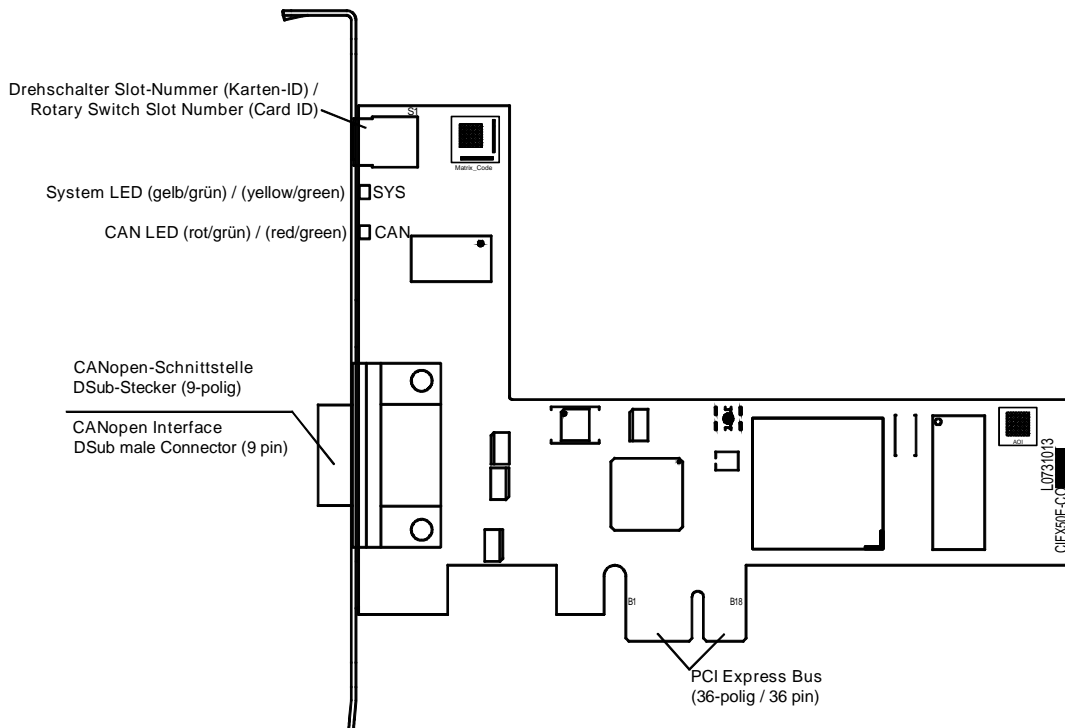

Figure 20: CIFX 50E-CO (from hardware revision 4)



Device drawings of earlier device revisions without rotary switch slot number (card ID) or with two COM LEDs are included in the user manual for PC cards cifX fieldbus up to manual rev. 23.

The figure below shows the front plate of the PC cards  
 CIFX 50-CO or CIFX 50E-CO:

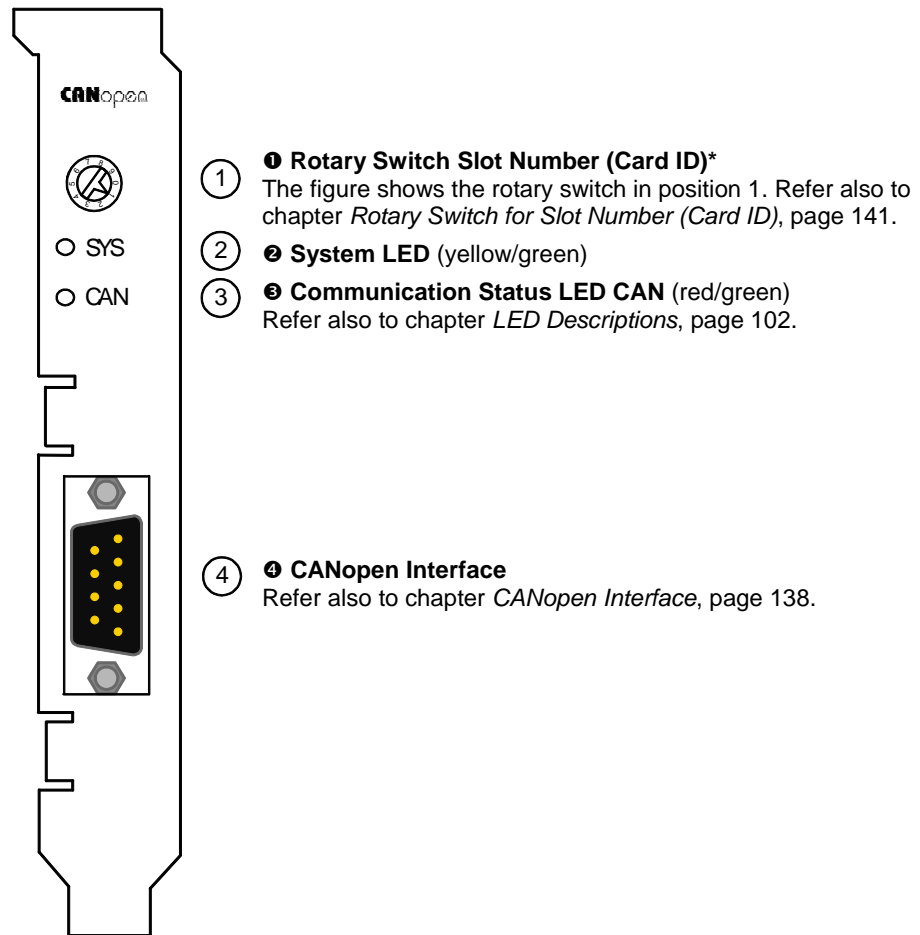

Figure 21: Front Plate for CIFX 50-CO or CIFX 50E-CO

\*From hardware revision 5 (for CIFX 50-CO or CIFX 50E-CO) on, the **Rotary Switch Slot Number (Card ID)** is provided.

### 5.1.8 CIFX 50-2CO, CIFX 50E-2CO

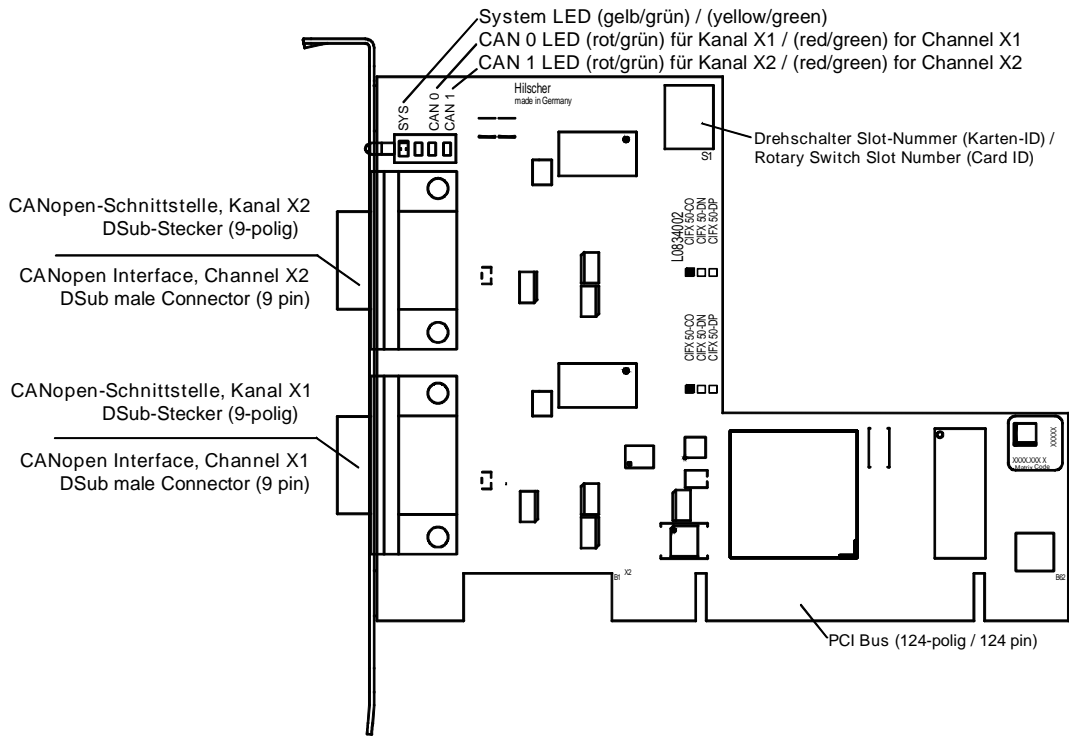

Figure 22: CIFX 50-2CO (Hardware Revision 2)

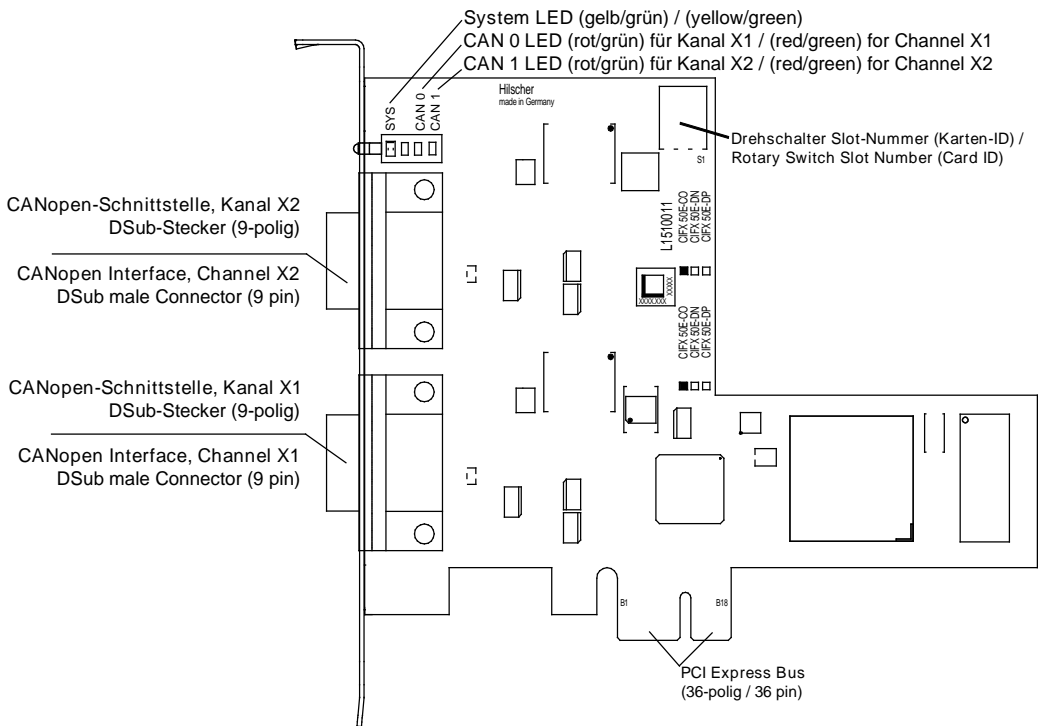

Figure 23: CIFX 50E-2CO (Hardware Revision 1)



The figure below shows the front plate of the PC cards  
 CIFX 50-2CO, CIFX 50E-2CO:

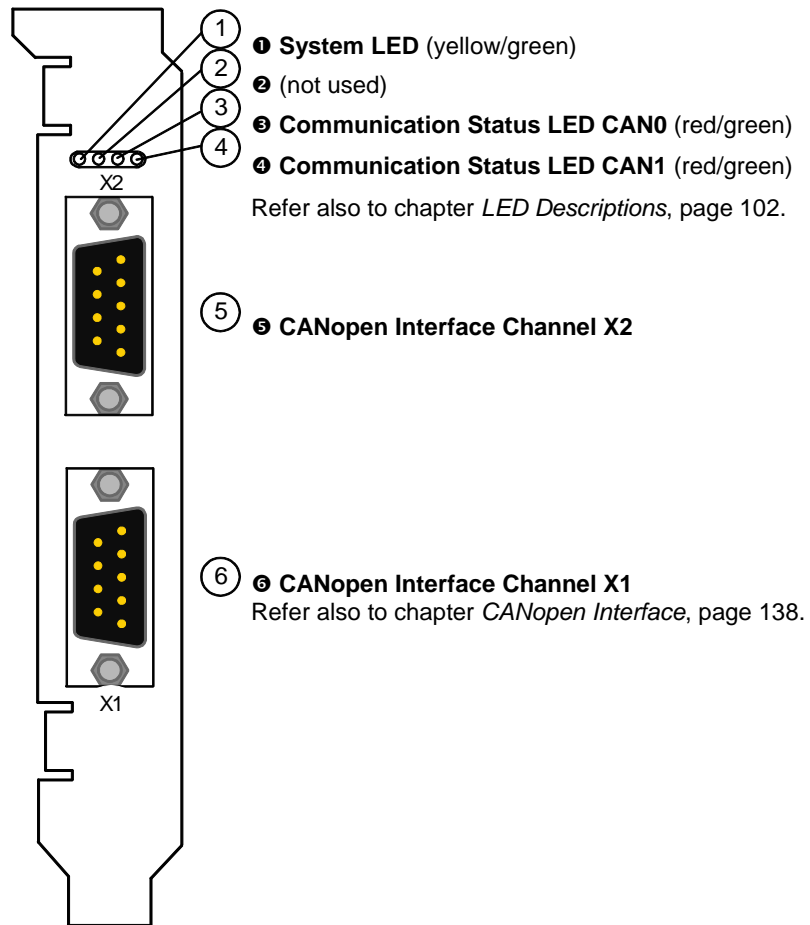

Figure 24: Front Plate CIFX 50-2CO, CIFX 50E-2CO

### 5.1.9 CIFX 50-2CO\DN, CIFX 50E-2 CO\DN

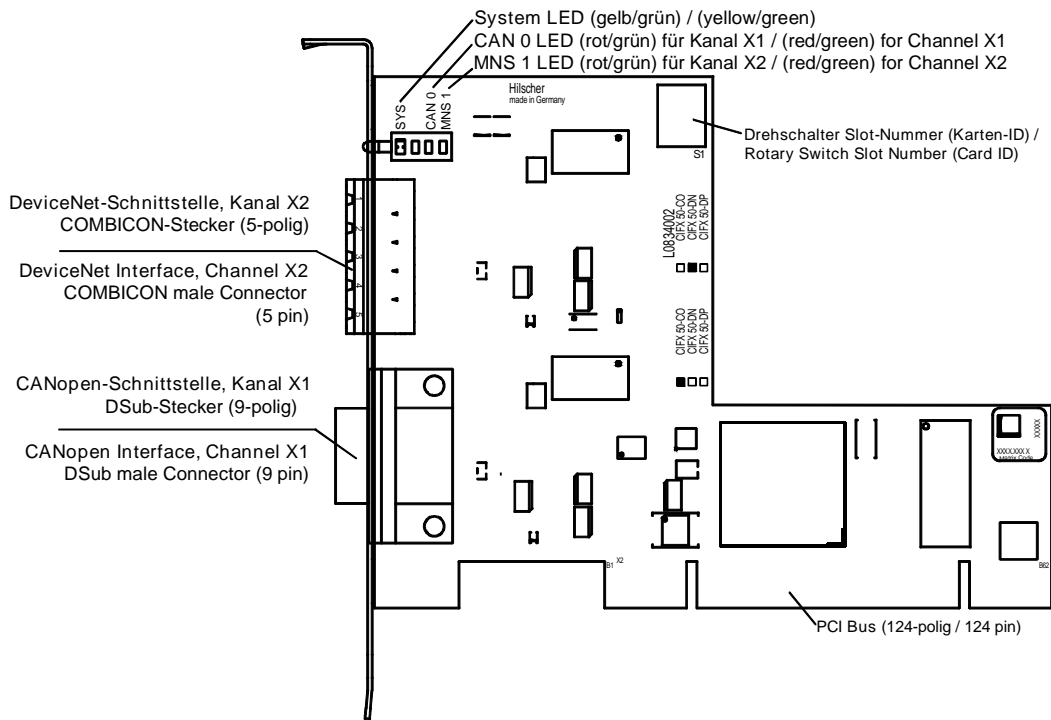

Figure 25: CIFX 50-2 CO\DN (Hardware Revision 1)

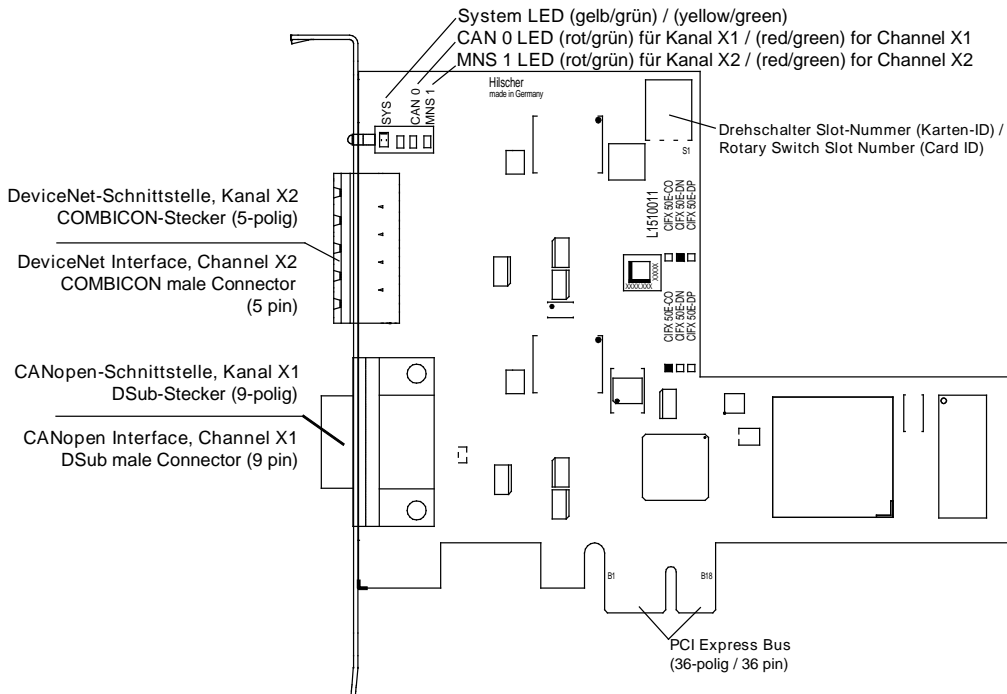

Figure 26: CIFX 50E-2 CO\DN (Hardware Revision 1)

The figure below shows the front plate of the PC cards  
 CIFX 50-2CO\DN, CIFX 50E-2 CO\DN:

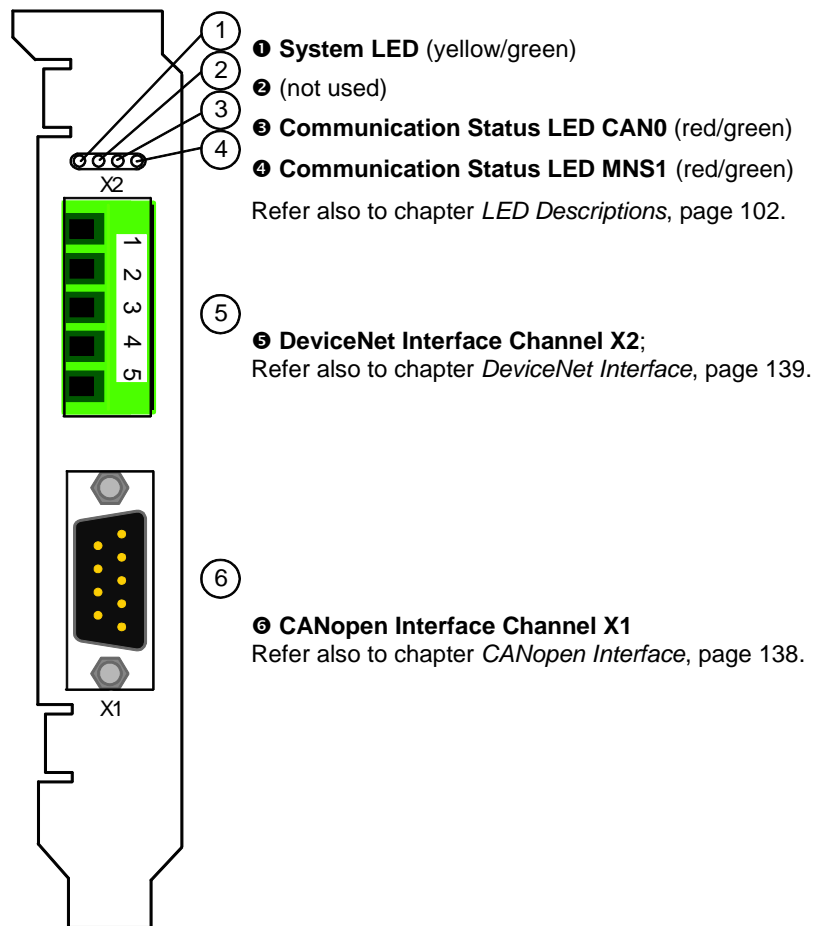

Figure 27: Front Plate CIFX 50-2CO\DN, CIFX 50E-2 CO\DN

### 5.1.10 CIFX 50-DN, CIFX 50E-DN

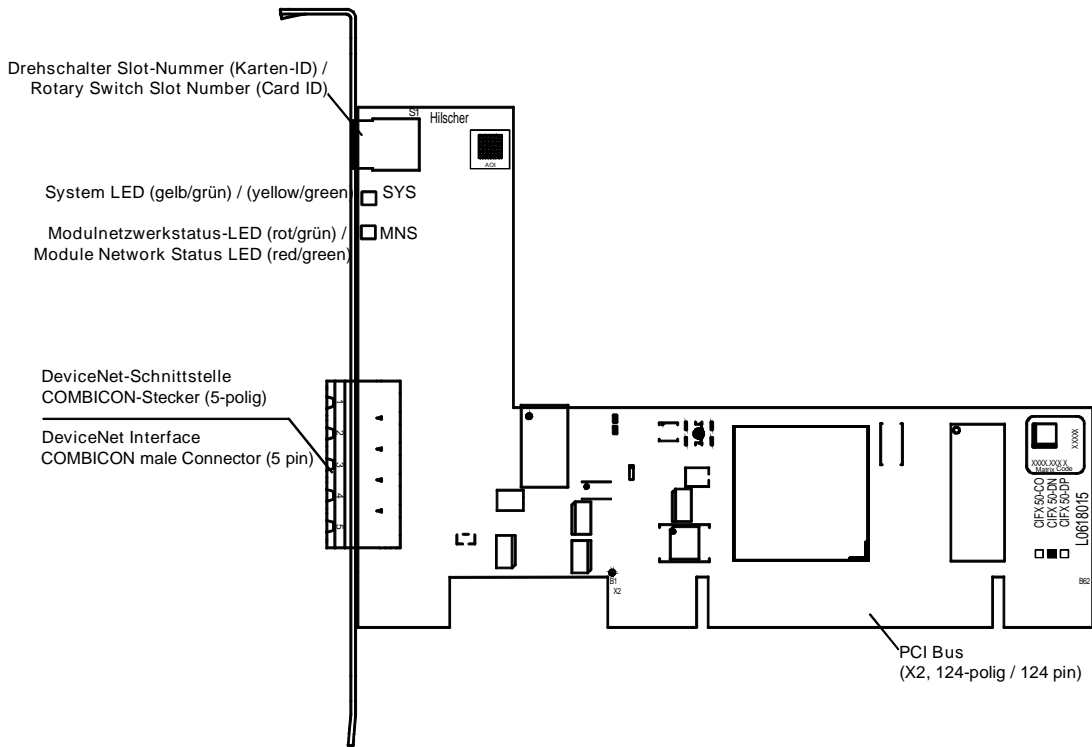

Figure 28: CIFX 50-DN (hardware revision 5)

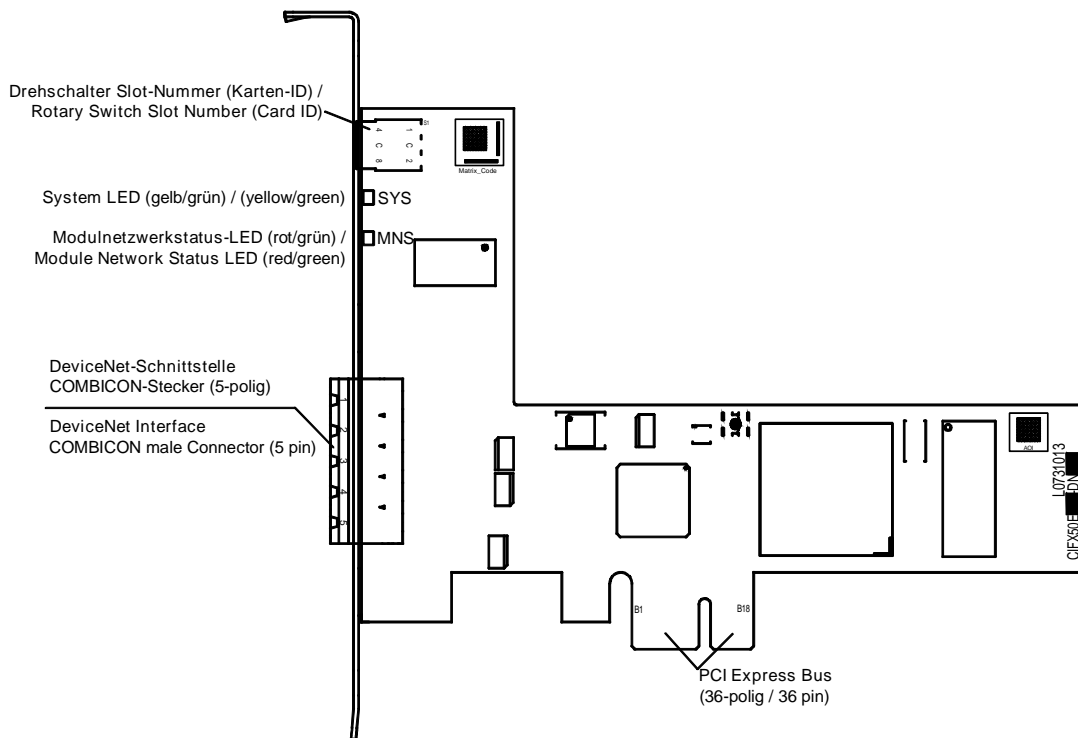

Figure 29: CIFX 50E-DN (from hardware revision 4)



Device drawings of earlier device revisions without rotary switch slot number (card ID) are included in the user manual for PC cards cifX fieldbus up to manual rev. 23.

The figure below shows the front plate of the PC cards CIFX 50-DN or CIFX 50E-DN:

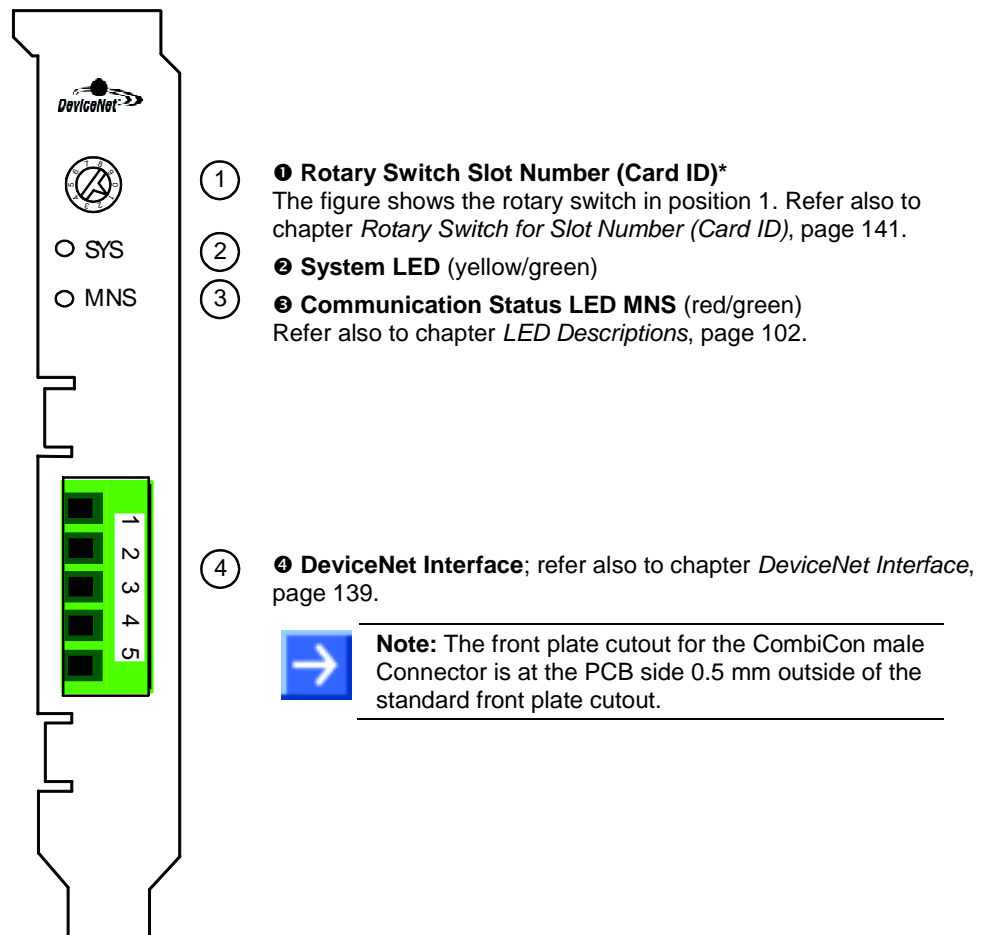

Figure 30: Front Plate CIFX 50-DN or CIFX 50E-DN

\*From hardware revision 5 (for CIFX 50-DN or CIFX 50E-DN on, the **Rotary Switch Slot Number (Card ID)** is provided.

### 5.1.11 CIFX 50-2DN, CIFX 50E-2DN

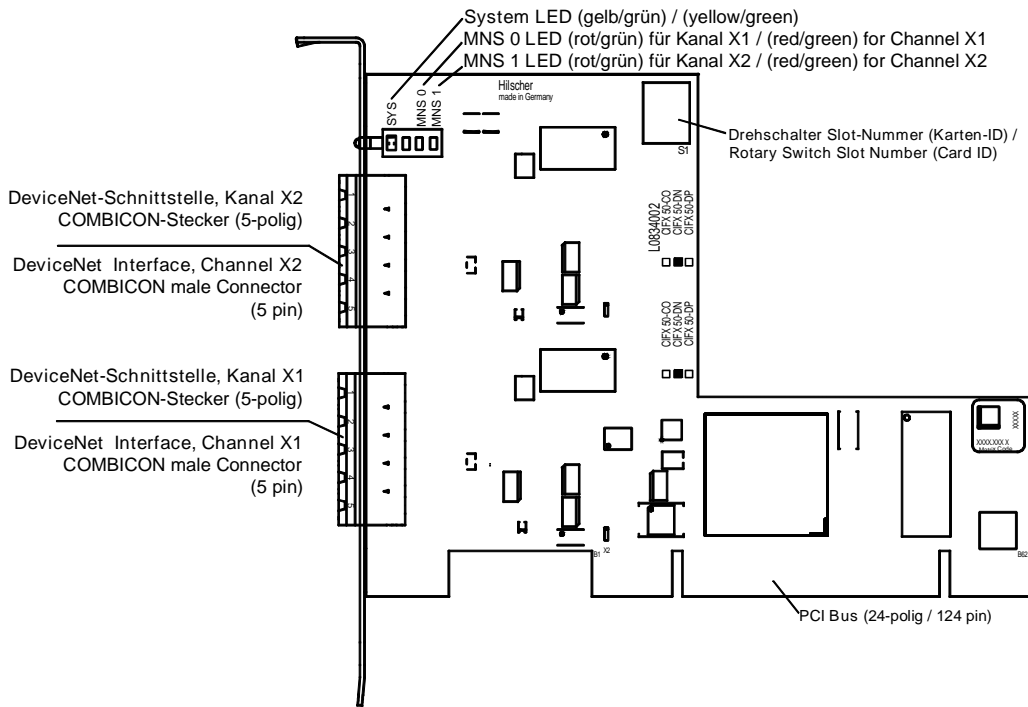

Figure 31: CIFX 50-2DN (Hardware Revision 2)

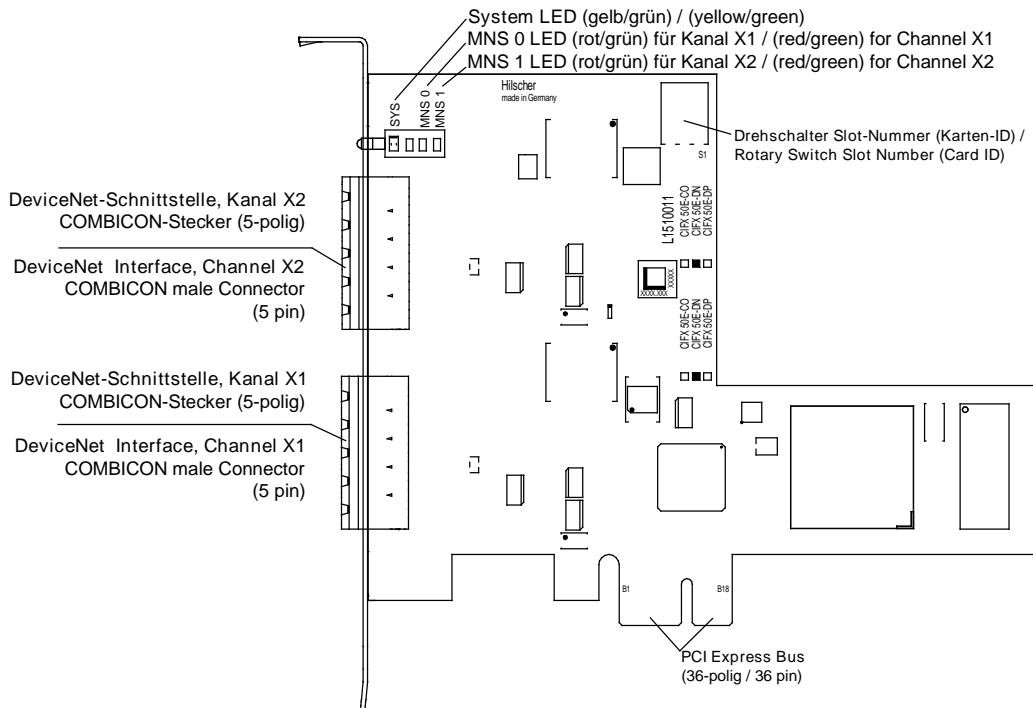

Figure 32: CIFX 50E-2DN (Hardware Revision 1)

The figure below shows the front plate of the PC cards  
 CIFX 50-2DN, CIFX 50E-2DN:

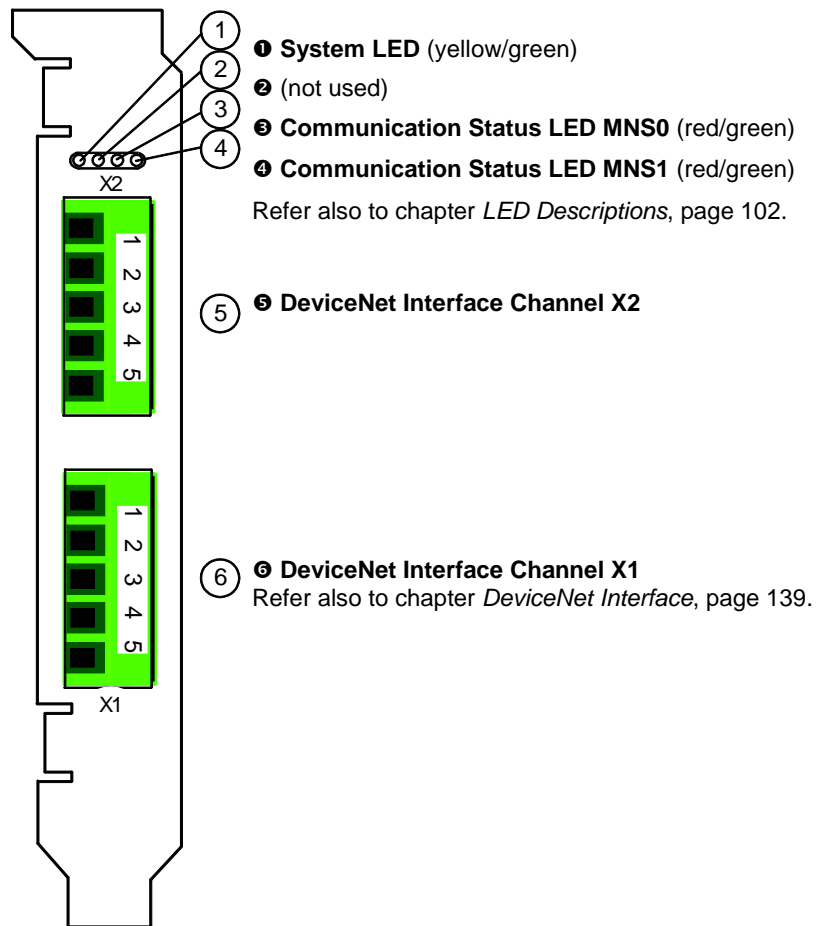

Figure 33: Front Plate CIFX 50-2DN, CIFX 50E-2DN

### 5.1.12 CIFX 50-2ASM, CIFX 50E-2ASM

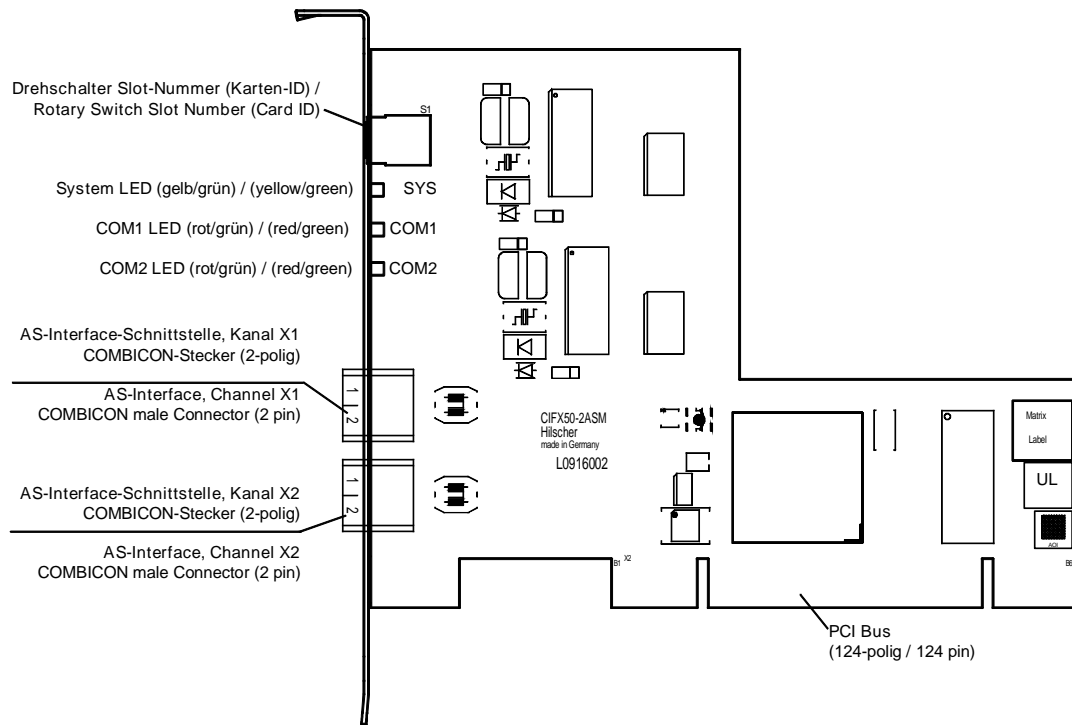

Figure 34: CIFX 50-2ASM (hardware revision 2)

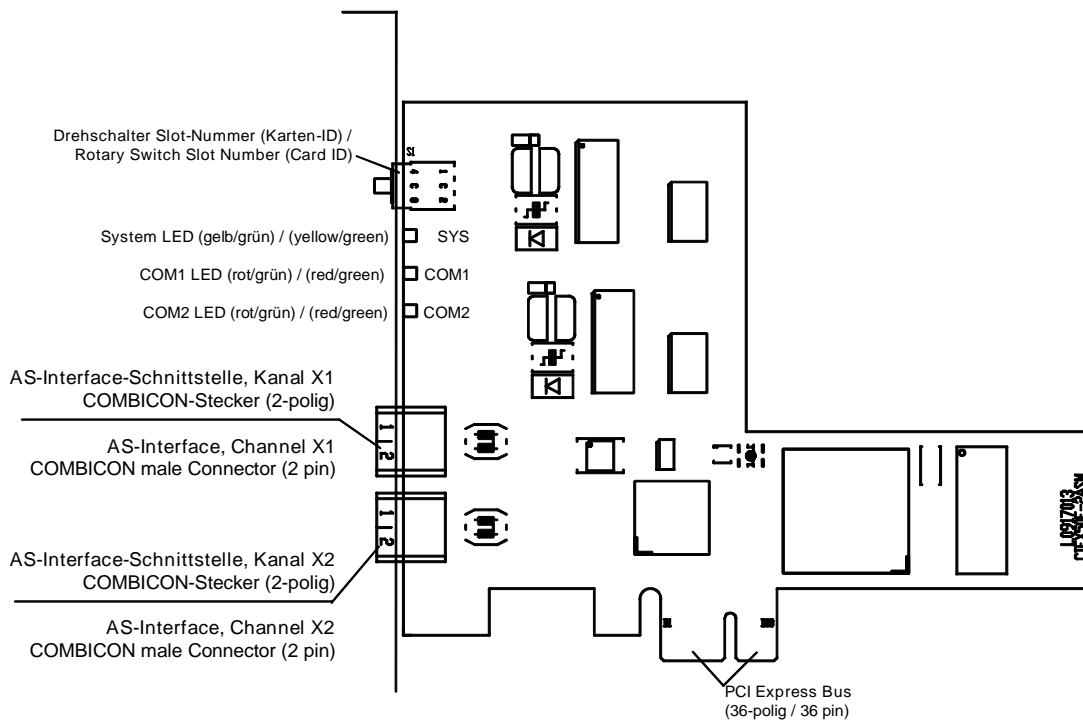

Figure 35: CIFX 50E-2ASM (from hardware revision 2)



Device drawings of earlier device revisions without rotary switch slot number (card ID) are included in the user manual for PC cards cifX fieldbus up to manual rev. 23.



The figure below shows the front plate of the PC card CIFX 50-2ASM:

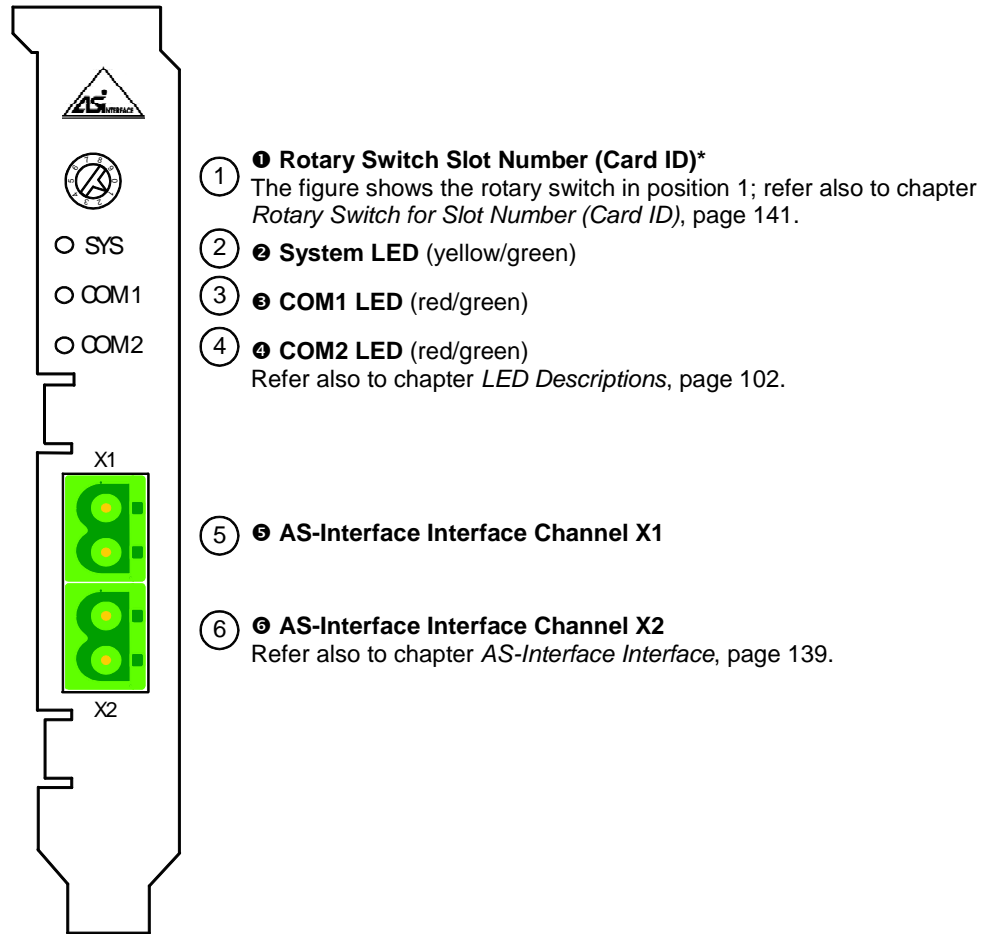

Figure 36: Front Plate CIFX 50-2ASM

\*From hardware revision 2 on, the **Rotary Switch Slot Number (Card ID)** is provided.

### 5.1.13 CIFX 50-CC, CIFX 50E-CC

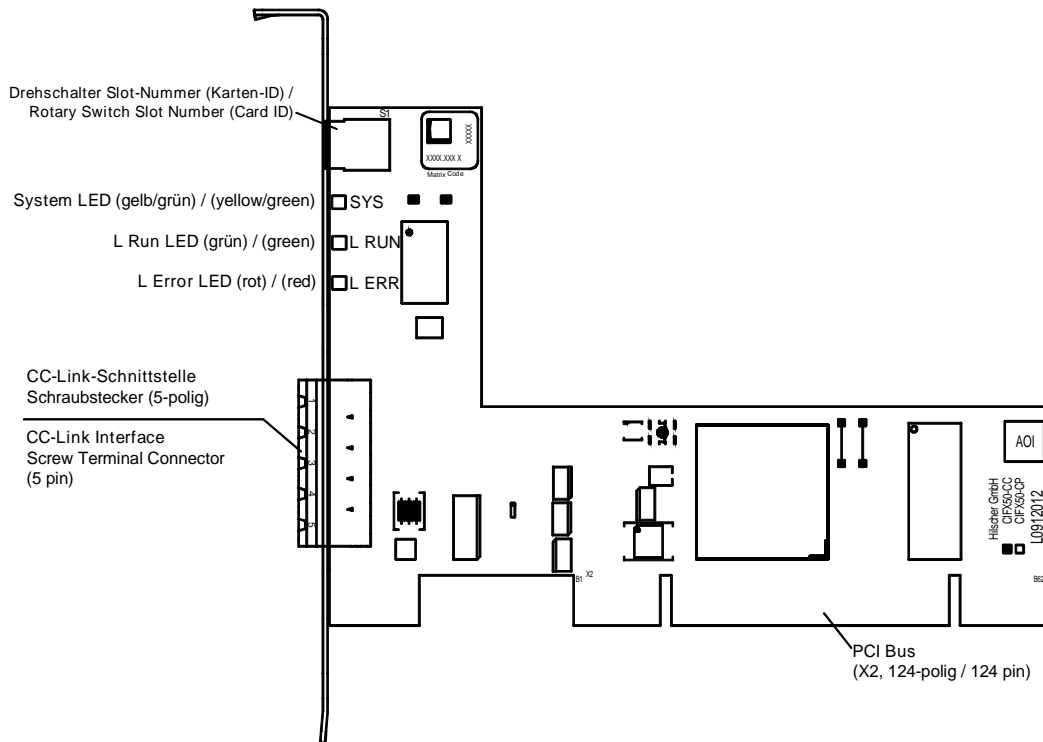

Figure 37: CIFX 50-CC (hardware revision 2)\*

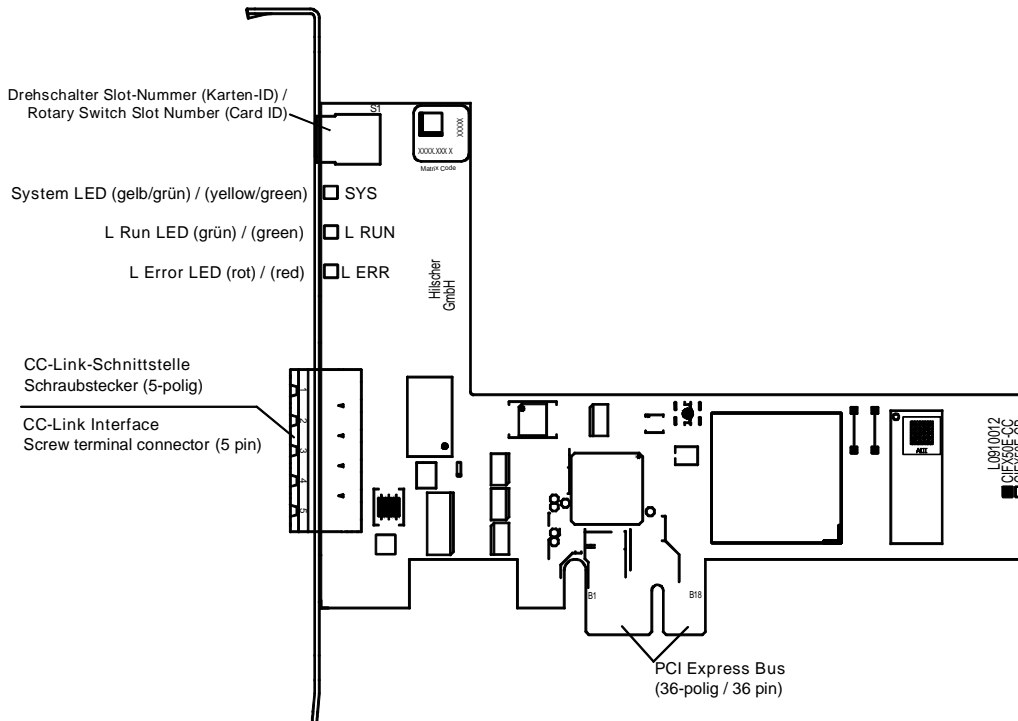

Figure 38: CIFX 50E-CC (hardware revision 4)\*



Device drawings of earlier device revisions without rotary switch slot number (card ID) are included in the user manual for PC cards cifX fieldbus up to manual rev. 23.



**Note:** \*The front plate cutout for the screw terminal connector is at the PCB side 0.5 mm outside of the standard front plate cutout.

The figure below shows the front plate of the PC cards CIFX 50-CC or CIFX 50E-CC:

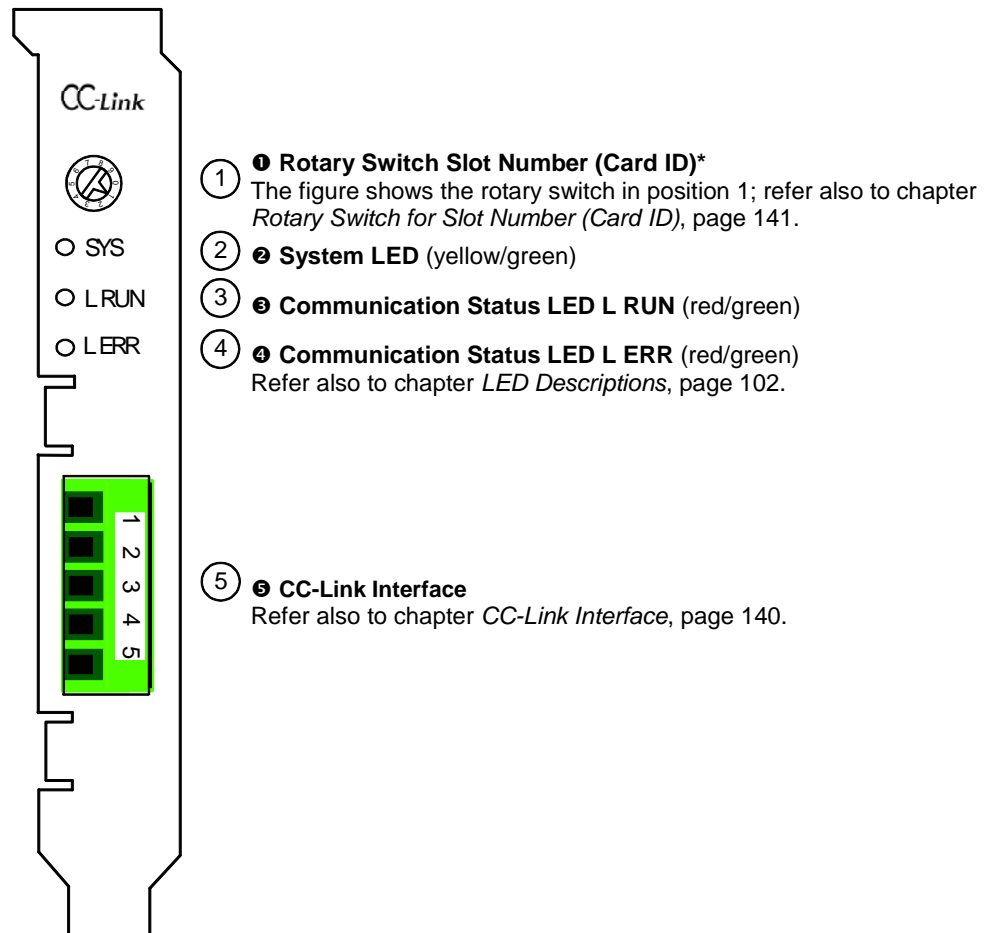

Figure 39: Front Plate CIFX 50-CC or CIFX 50E-CC

\*From hardware revision 2 (for CIFX 50-CC) on or 3 (for CIFX 50E-CC), the **Rotary Switch Slot Number (Card ID)** is provided.

### 5.1.14 Meaning of the Front Panel Inscriptions for 2 Channel Devices

PC card cifX	Channel X1	Channel X2
CIFX 50-2DP, CIFX 50E-2DP	COM0	COM1
CIFX 50-2DP\CO, CIFX 50E-2DP\CO	COM0	CAN1
CIFX 50-2DP\DN, CIFX 50E-2DP\DN	COM0	MNS1
CIFX 50-2CO, CIFX 50E-2CO	CAN0	CAN1
CIFX 50-2CO\DN, CIFX 50E-2CO\DN	CAN0	MNS1
CIFX 50-2DN, CIFX 50E-2DN	MNS0	MNS1
CIFX 50-2ASM, CIFX 50E-2ASM	COM1	COM2

Table 31: Assignment of the LEDs to the Channels

X1 and X2 indicate the bus interfaces: X1 stands for fieldbus 1 (channel X1), X2 stands for fieldbus 2 (channel X2).



**Note:** Within the configuration software SYCON.net the communication channels are named with 'Ch0', 'Ch1' ... .

## 5.2 PC Cards cifX Low Profile PCI Express

### 5.2.1 CIFX 70E-RE, CIFX 70E-REMR

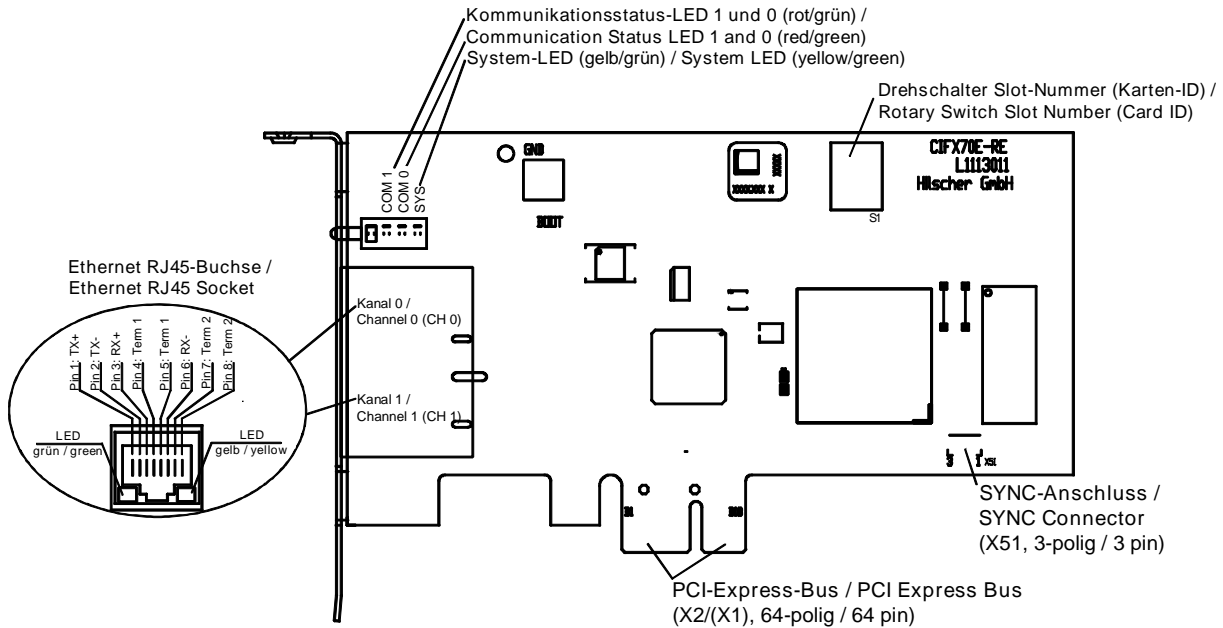

Figure 40: CIFX 70E-RE\* (Hardware revision 1)

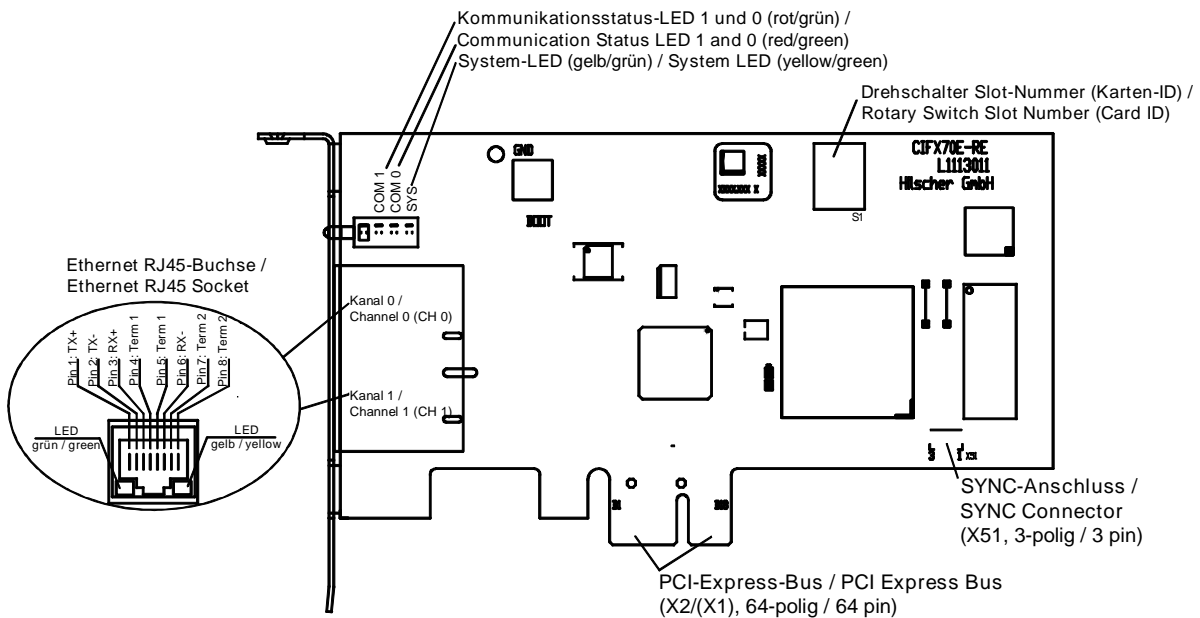

Figure 41: CIFX 70E-REMR\* (Hardware revision 1)



**Note:** \*Device supports Auto Crossover Function. Note also: With loaded EtherCAT Master firmware only the RJ45 channel 0 can be used, channel 1 is deactivated. Beginning with the EtherCAT Master firmware version 3 channel 1 can be reactivated if redundancy is activated. For Open Modbus/TCP with V2.3.4.0 and higher both RJ45 channels can be used.



About **Rotary Switch for Slot Number (Card ID)** refer to section *Rotary Switch for Slot Number (Card ID)*, on page 141.

For the **SYNC** pin assignment of the SYNC Connector refer to section *Pin Assignment SYNC Connector, X51 (CIFX 50 50E 70E)* on page 143.

The figure below shows the front plate of the PC card CIFX 70E-RE or , CIFX 70E-REVMR:

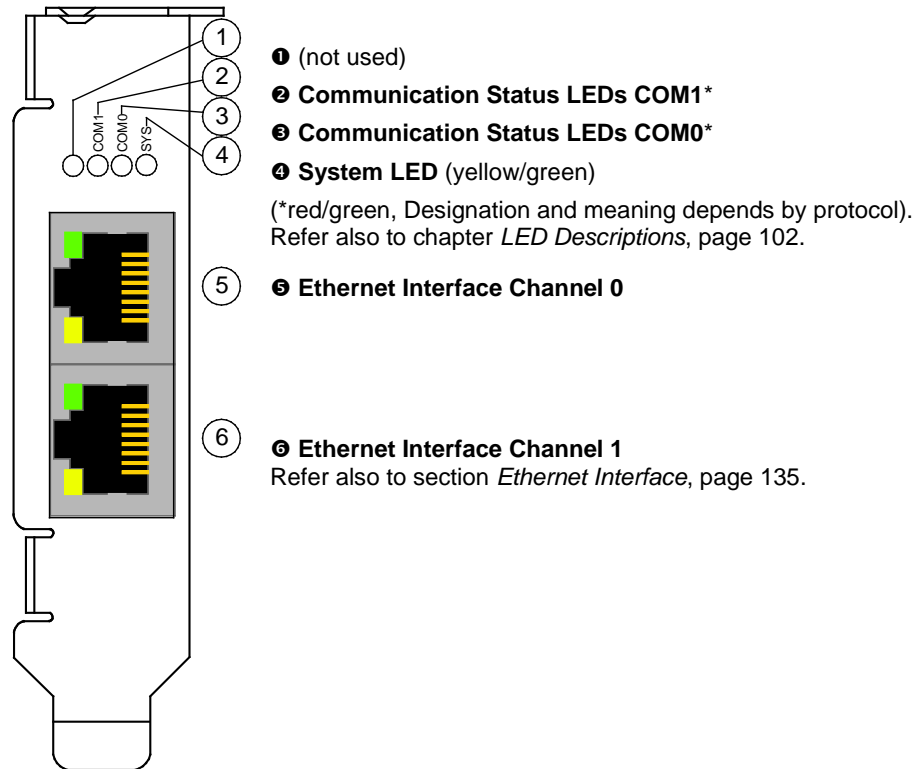

Figure 42: Front Plate for CIFX 70E-RE, CIFX 70E-REVMR

### 5.2.2 CIFX 70E-CCIES

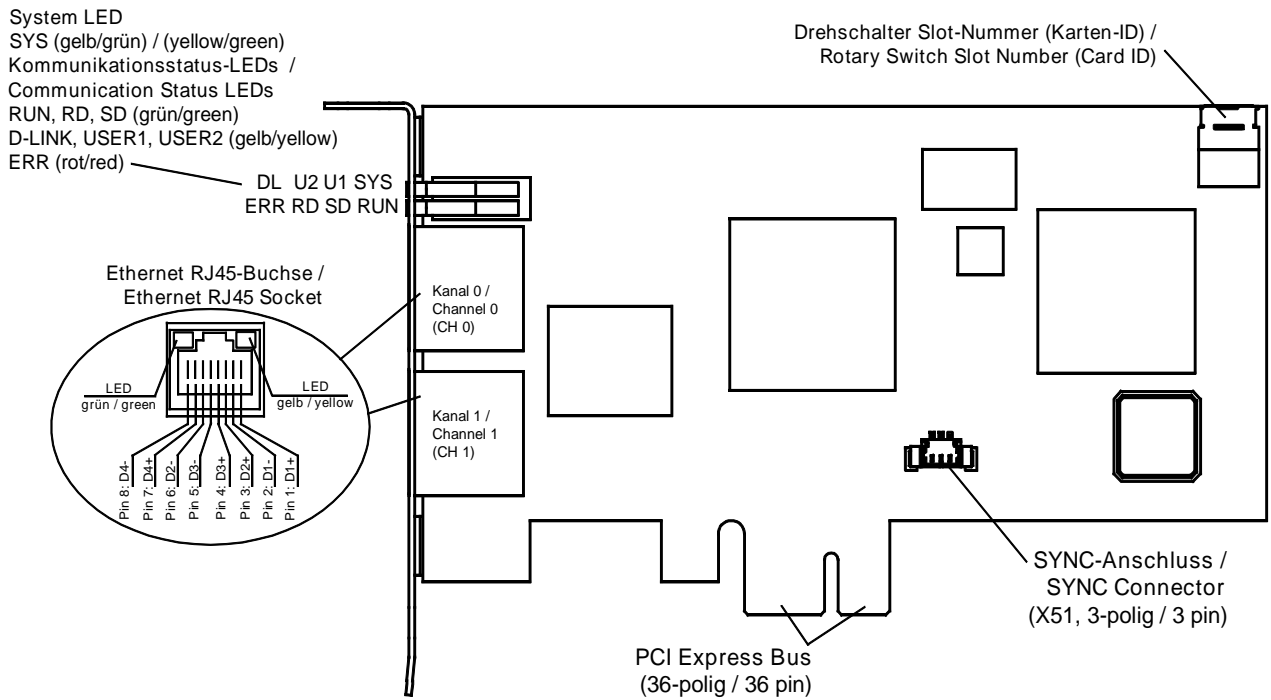

Figure 43: CIFX 70E-CCIES\* (Hardware revision 1)



**Note:** \*Device supports Auto Crossover Function.



For details about the **Rotary Switch Slot Number (Card ID)** refer to section *Rotary Switch for Slot Number (Card ID)*, page 141.

For the **SYNC** pin assignment of the SYNC Connector refer to section *Pin Assignment SYNC Connector, X51 (CIFX 50 50E 70E)* on page 143.

The figure below shows the front plate of the PC card CIFX 70E-CCIES:

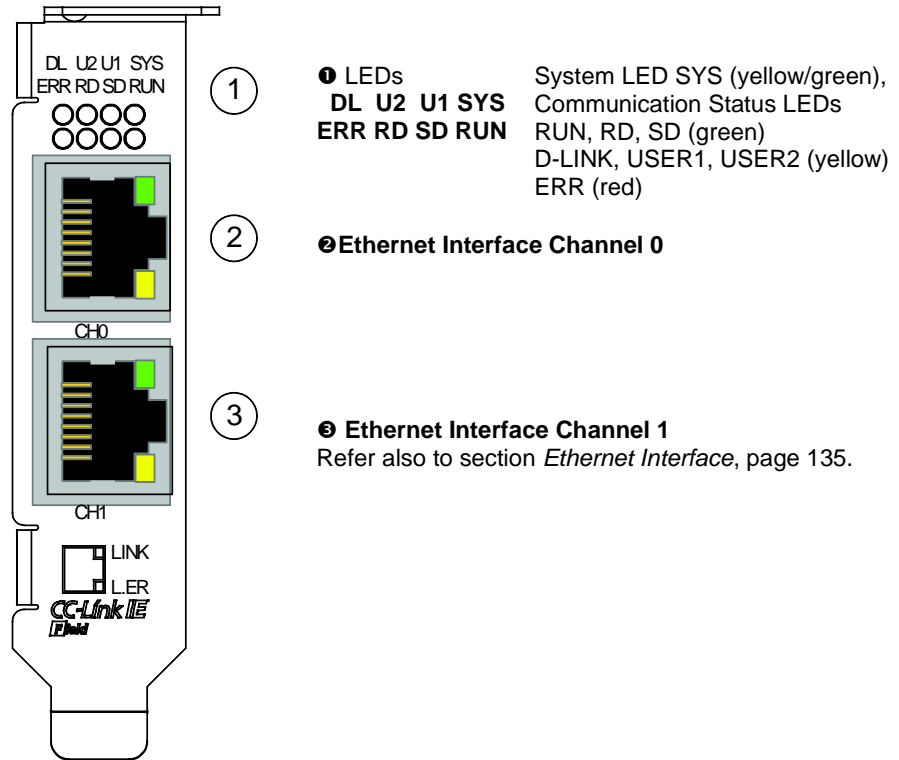

Figure 44: Front Plate for CIFX 70E-CCIES

### 5.2.3 CIFX 100EH-RE\CUBE

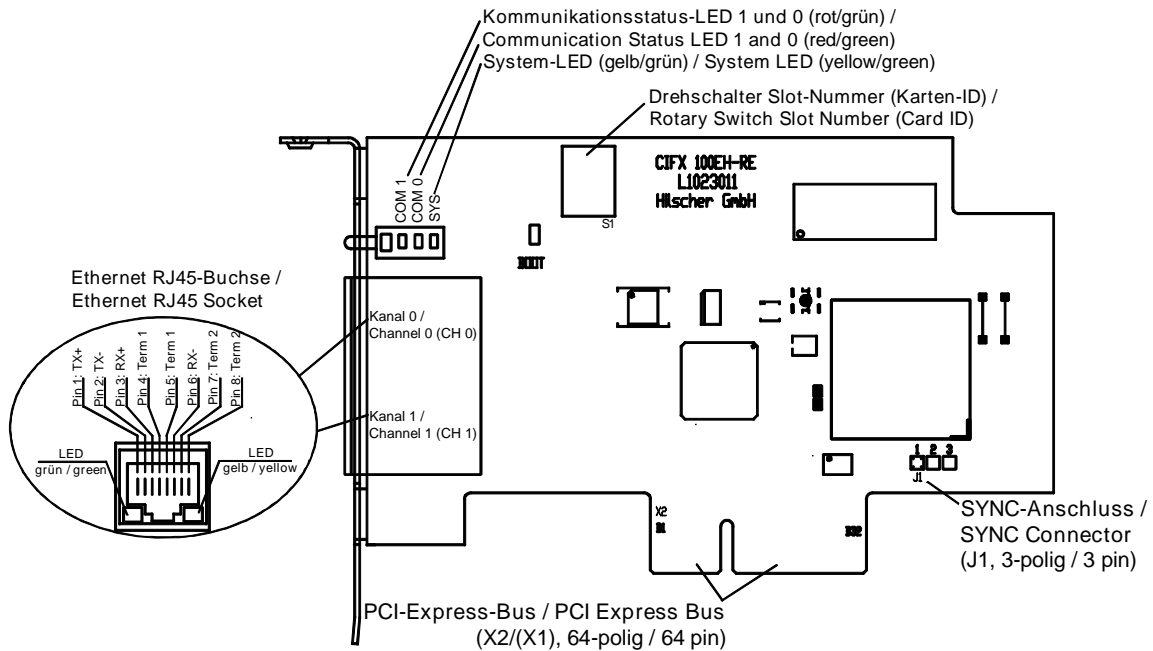
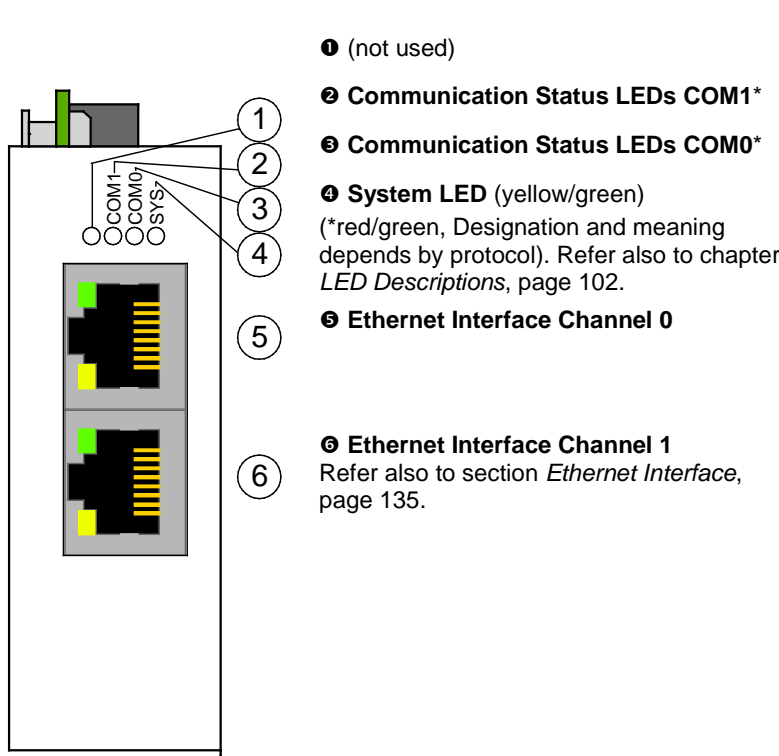

Figure 45: CIFX 100EH-RE\CUBE\*

The figure below shows the front plate of the PC card CIFX 100EH-RE\CUBE:



**Note:** \*Device supports Auto Crossover Function. Note also: With loaded EtherCAT Master firmware only the RJ45 channel 0 can be used, channel 1 is deactivated. Beginning with the EtherCAT Master firmware version 3 channel 1 can be reactivated if redundancy is activated. For Open Modbus/TCP with V2.3.4.0 and higher both RJ45 channels can be used.



About **Rotary Switch for Slot Number (Card ID)** refer to section *Rotary Switch for Slot Number (Card ID)*, on page 141.

For the pin assignment of the **PCI Express** bus X2(X1) see section *Pin Assignment for PCI Express Bus CIFX 100EH-RE\CUBE* on page 146.

For the **SYNC** pin assignment of the SYNC Connector refer to section *Pin Assignment SYNC Connector, J1 (CIFX 100EH)* on page 143.

Figure 46: Front Plate CIFX 100EH-RE\CUBE



### 5.2.4 CIFX 70E-DP, CIFX 70E-DPWR

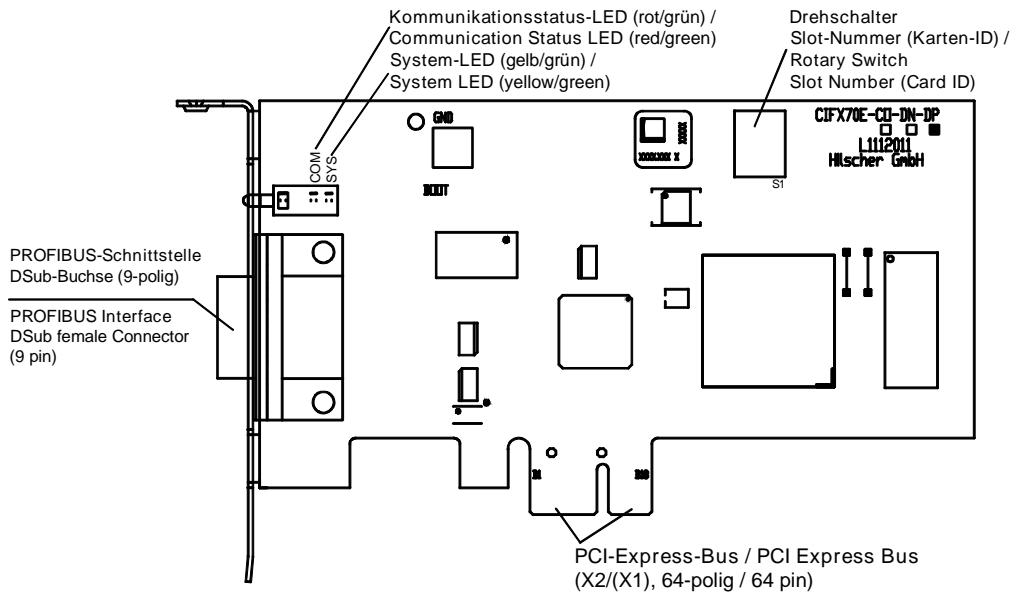

Figure 47: CIFX 70E-DP (Hardware revision 1)

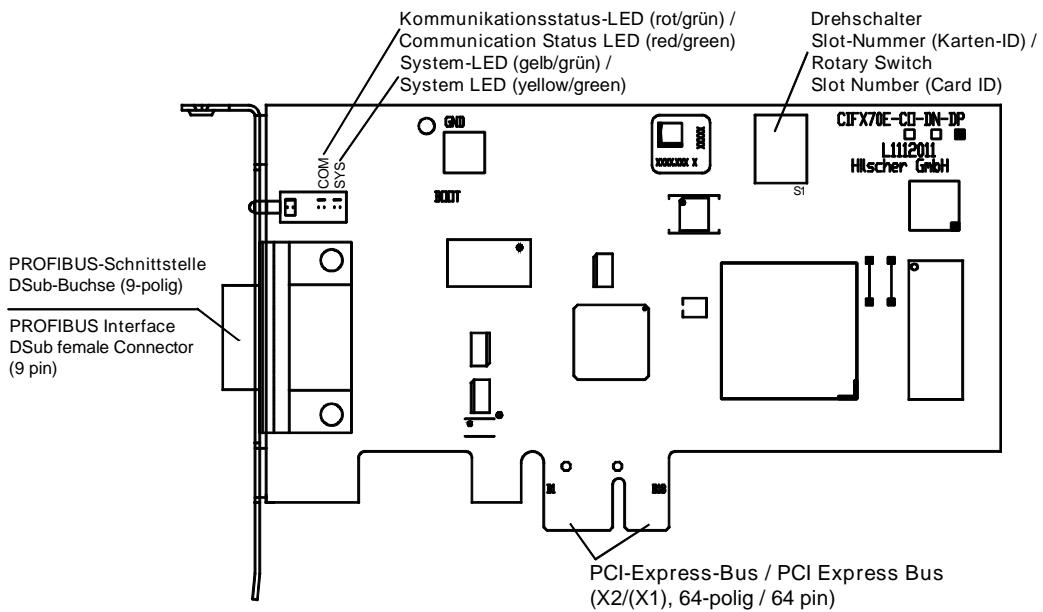

Figure 48: CIFX 70E-DPWR (Hardware revision 1)



About **Rotary Switch for Slot Number (Card ID)** refer to section *Rotary Switch for Slot Number (Card ID)*, on page 141.

The figure below shows the front plate of the PC card CIFX 70E-DP or CIFX 70E-DPVMR:

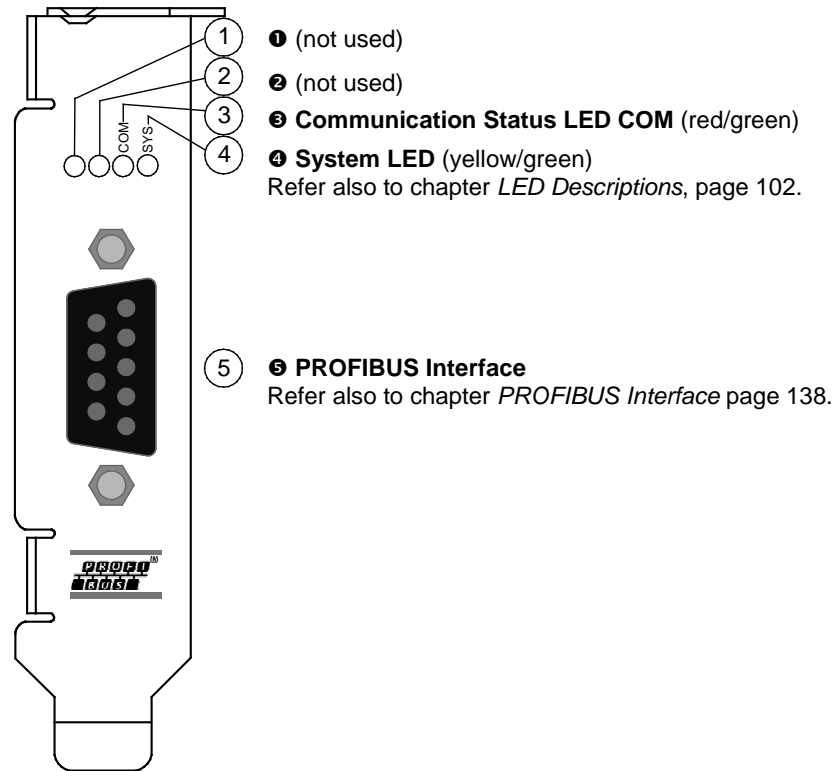

Figure 49: Front Plate CIFX 70E-DP, CIFX 70E-DPVMR

### 5.2.5 CIFX 70E-CO, CIFX 70E-CO\MR

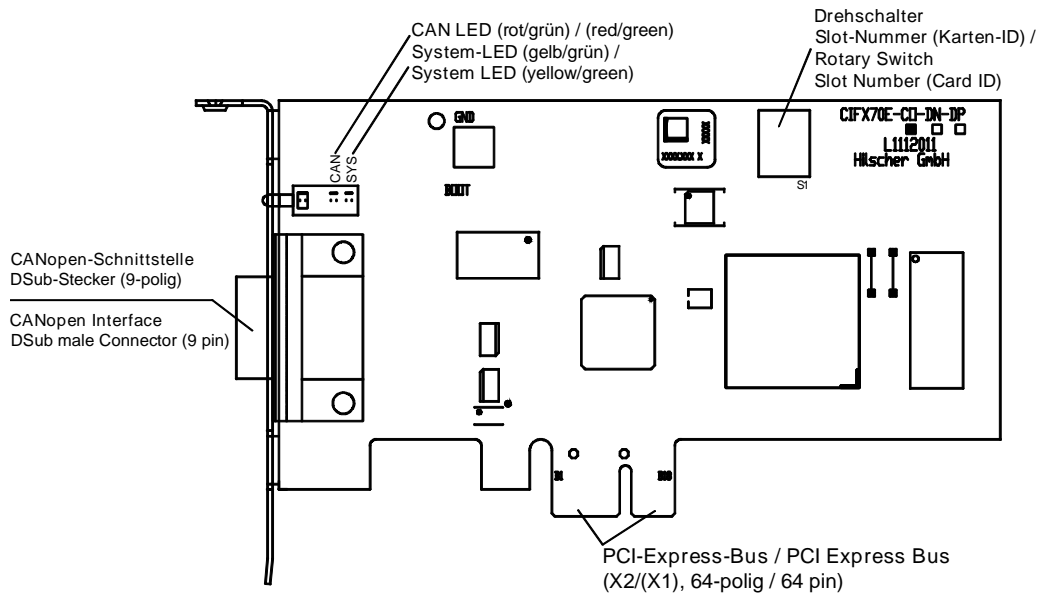

Figure 50: CIFX 70E-CO (Hardware revision 1)

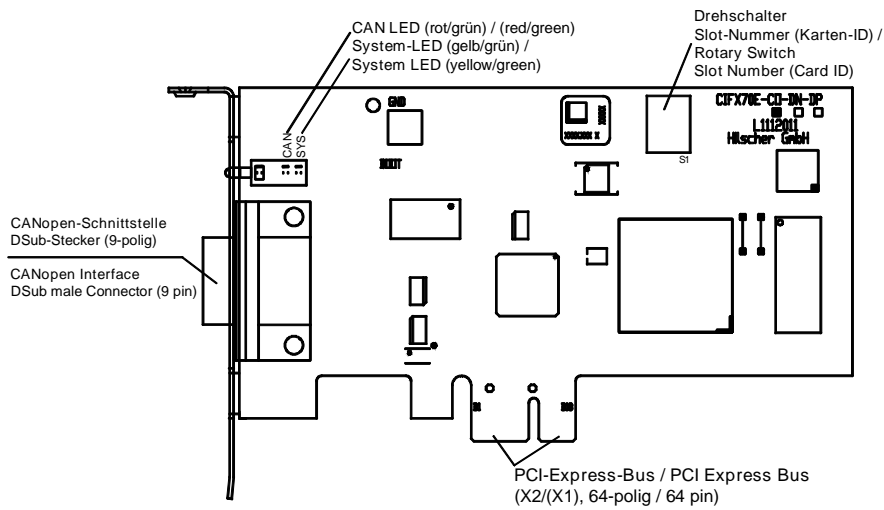

Figure 51: CIFX 70E-CO\MR (Hardware revision 1)



About **Rotary Switch for Slot Number (Card ID)** refer to section *Rotary Switch for Slot Number (Card ID)*, on page 141.

The figure below shows the front plate of the PC card CIFX 70E-CO or CIFX 70E-COMR:

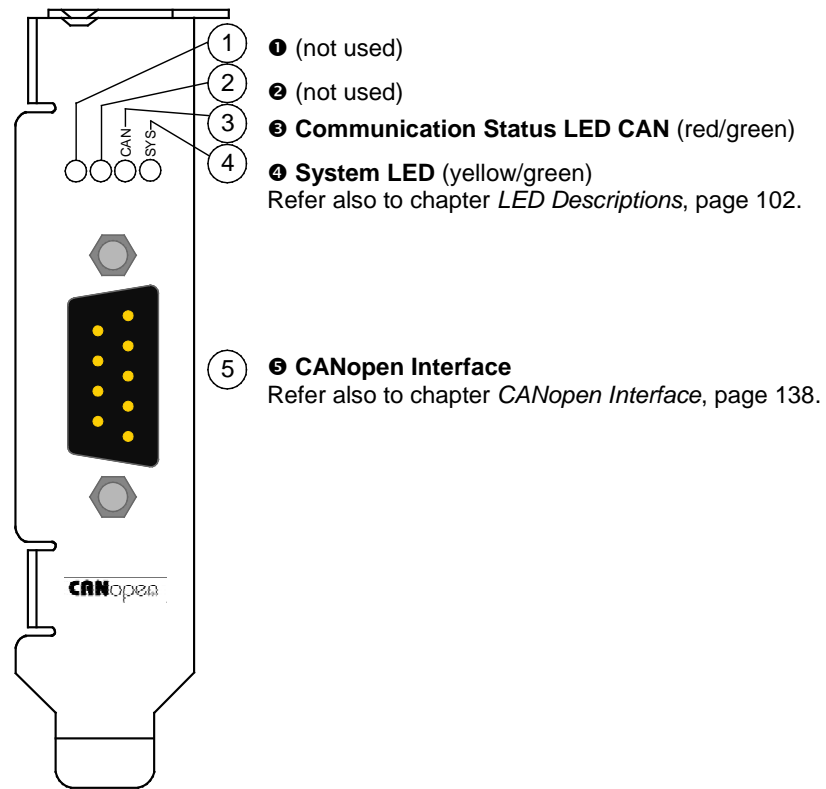

Figure 52: Front Plate CIFX 70E-CO, CIFX 70E-COMR

### 5.2.6 CIFX 70E-DN, CIFX 70E-DN\MR

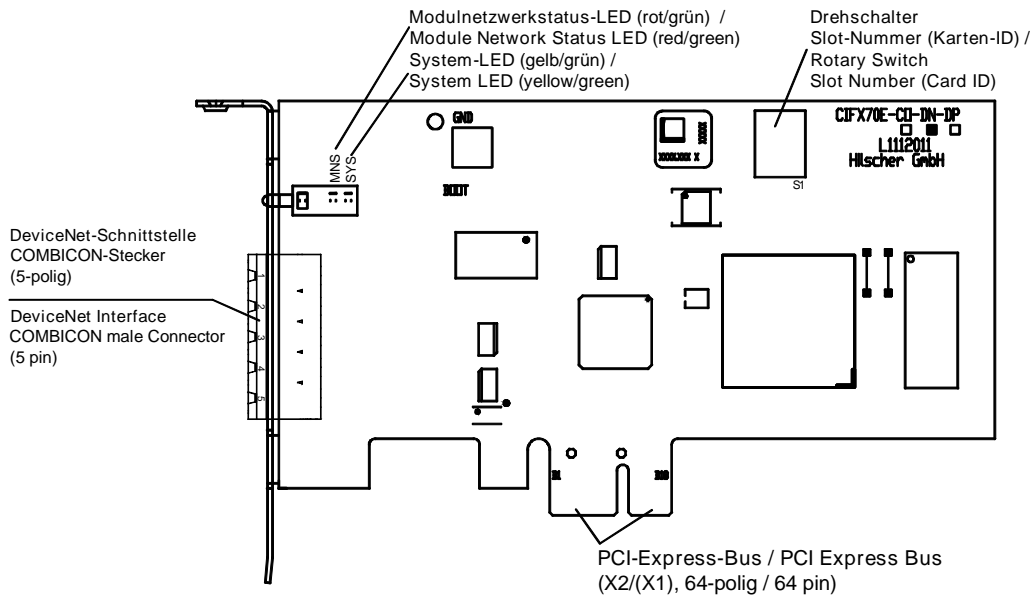

Figure 53: CIFX 70E-DN (Hardware revision 1)

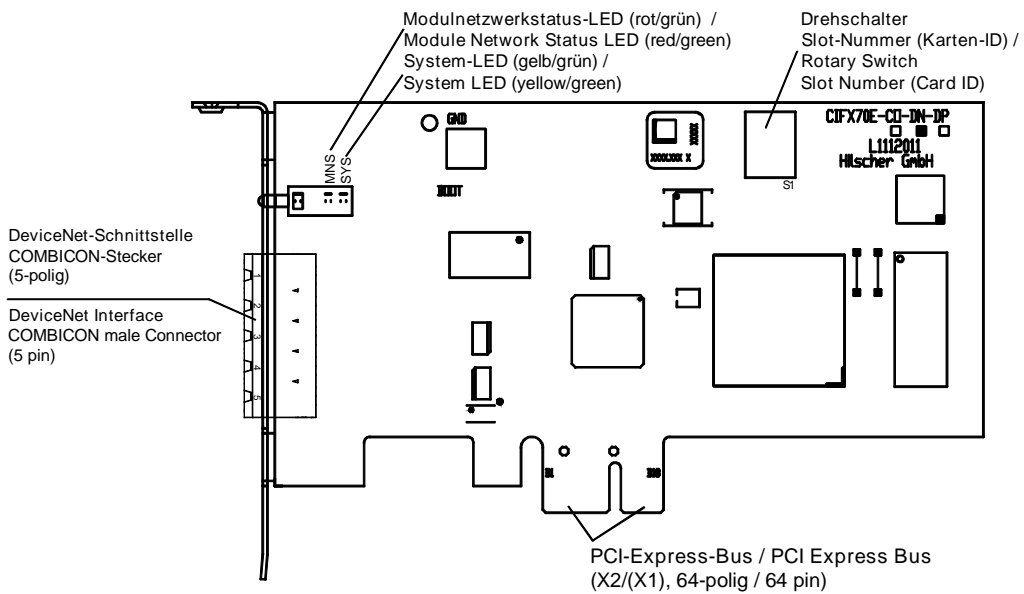

Figure 54: CIFX 70E-DNMR (Hardware revision 1)



About **Rotary Switch for Slot Number (Card ID)** refer to section *Rotary Switch for Slot Number (Card ID)*, on page 141.

The figure below shows the front plate of the PC card CIFX 70E-DN or CIFX 70E-DNMR:

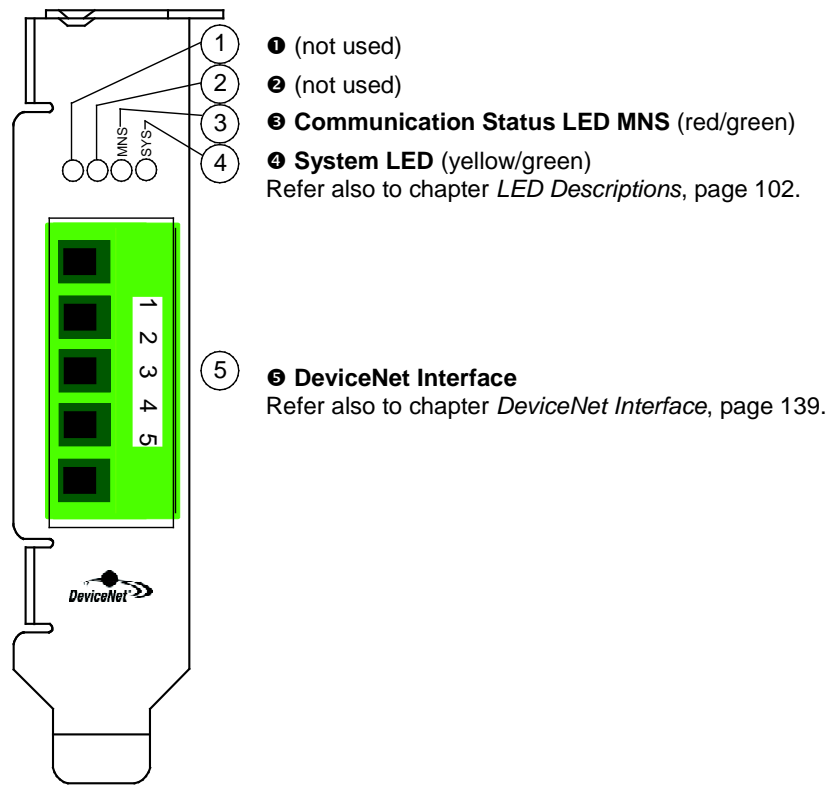

Figure 55: Front Plate CIFX 70E-DN, CIFX 70E-DNMR

## 6 Hardware Installation and Uninstalling

To install / uninstall the PC Cards cifX **PCI** the PC Cards cifX **PCI Express**

- CIFX 50-RE,
- CIFX 50-DP, CIFX 50-CO,
- CIFX 50-DN, CIFX 50-CC,
- CIFX 50E-RE, CIFX 50E-RE\ET,
- CIFX 50E-CCIE,
- CIFX 50E-DP, CIFX 50E-CO,
- CIFX 50E-DN, CIFX 50E-CC
- CIFX 50-2DP,
- CIFX 50-2DP\CO, CIFX 50-2DP\DN,
- CIFX 50-2CO, CIFX 50-2CO\DN,
- CIFX 50-2DN,
- CIFX 50-2ASM,
- CIFX 50E-2ASM

and **Low Profile PCI Express**

- CIFX 70E-RE, CIFX 70E-RE\MR,
- CIFX 70E-CCIE,
- CIFX 100EH-RE\CUBE
- CIFX 70E-DP, CIFX 70E-DP\MR,
- CIFX 70E-CO, CIFX 70E-CO\MR,
- CIFX 70E-DN, CIFX 70E-DN\MR

handle as described in the sections hereafter. The device drawing of your PC card cifX gives information on the manual control elements of your device.



For the installation, uninstalling and replacement of the PC card cifX **adhere to the necessary safety precautions** given in the safety chapter and in section *Warnings* on page 47 and check any notes in the overview given *Getting Started* on page 47.

## 6.1 Fix Front Plate Sticker

### 6.1.1 Front Plate Sticker CIFX 50-RE, CIFX 50E-RE, CIFX 50E-RE\ET



**Note:** Your PC card cifX set contains a set of front plate stickers (9 different stickers). Depending from the loaded firmware the label on each sticker indicates for the respective system the following **LED names**:

- of the **system and communication status LEDs** (*above*)
- of the **RJ45 Ethernet female connector LEDs** (*below*).

Further information to this question you find also in chapter *LED Descriptions* beginning from page 102.



#### NOTICE

#### Electrostatically sensitive Devices

- To prevent damage to the PC and the PC card cifX, make sure, that the PC card cifX is grounded via the endplate and the PC and make sure, that you are discharged when you install/uninstall the PC card cifX.
- Use the sticker according to the device and firmware and glue it on the front of the PC card CIFX 50-RE, CIFX 50E-RE or CIFX 50E-RE\ET.

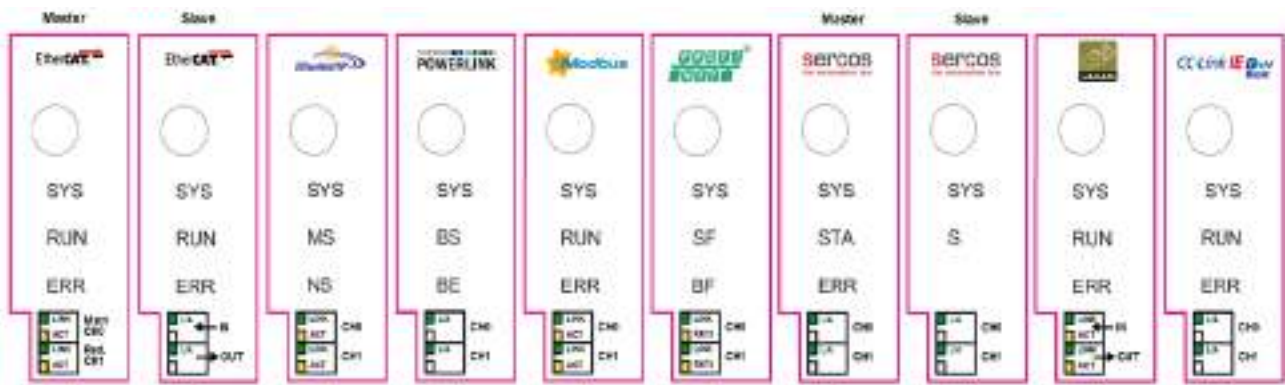

Figure 56: Front Plate Stickers for CifX 50-RE, CifX 50E-RE or CifX 50E-RE\ET

LED	EtherCAT Master	EtherCAT Slave	EtherNet/IP	Open Modbus/TCP	POWERLINK	PROFINET IO	Sercos Master	Sercos Slave	VARAN	CC-Link IE Field Basic	
SYS (yellow/green)	SYS	SYS	SYS	SYS	SYS	SYS	SYS	SYS	SYS	SYS	
COM 0 (red/ green)	RUN	RUN	MS	RUN	BS	SF	STA	S	RUN	RUN	
COM 1 (red/ green)	ERR	ERR	NS	ERR	BE	BF	ERR	-	ERR	ERR	
RJ45 Ch0	green	LINK	L/A IN	LINK	LINK	L/A	LINK	L/A	L/A	LINK IN	L/A
	yellow	ACT	-	ACT	ACT	-	RX/TX	-	-	ACT IN	-
RJ45 Ch1	green	LINK	L/A OUT	LINK	LINK	L/A	LINK	L/A	L/A	LINK OUT	L/A
	yellow	ACT	-	ACT	ACT	-	RX/TX	-	-	ACT OUT	-

Table 32: LED Labeling depending of the loaded Firmware



## 6.1.2 Front Plate Sticker CIFX 70E-RE, CIFX 70E-REMR, CIFX 100EH-RE\CUBE



**Note:** Your PC card CIFX 70E-RE, CIFX 70E-REMR or CIFX 100EH-RE\CUBE set contains a set of front plate stickers (9 different stickers, each 2 parts). Depending from the loaded firmware the label on each sticker indicates for the respective system the following **LED names**:  
 (1) of the **system and communication status LEDs** (*partial sticker above*)  
 (2) of the **RJ45 Ethernet female connector LEDs** (*partial sticker below*).  
 Further information to this question you find also in chapter *LED Descriptions* beginning from page 102.

### NOTICE

#### Electrostatically sensitive Devices

- To prevent damage to the PC and the PC card cifX, make sure, that the PC card cifX is grounded via the endplate and the PC and make sure, that you are discharged when you install/uninstall the PC card cifX.
- Use the two part sticker according to the device and firmware and glue it on the front of the PC card CIFX 70E-RE, CIFX 70E-REMR or CIFX 100EH-RE\CUBE.

Front CIFX 100EH-RE\CUBE	Front CIFX 70E-RE, CIFX 70E-REMR	How to
		<ol style="list-style-type: none"> <li>1. Glue the "partial sticker above" with the system specific <b>names of the system and communication status LEDs</b> above ① of the LEDs COM1, COM0 and SYS on the front plate.</li> <li>2. Glue the "partial sticker below " with the system specific <b>names of the RJ45 Ethernet female connector LEDs</b> below ② of the RJ45 on the front plate.</li> </ol>

Table 33: Fix Front Plate Sticker at the CIFX 70E-RE, CIFX 70E-REMR or CIFX 100EH-RE\CUBE



Figure 57: Front Plate Stickers for CIFX 70E-RE, CIFX 70E-REMR

LED	EtherCAT Master	EtherCAT Slave	EtherNet/IP	Open Modbus/TCP	POWERLINK	PROFINET IO	Sercos Master	Sercos Slave	VARAN	CC-Link IE Field Basic	
SYS (yellow/green)	SYS	SYS	SYS	SYS	SYS	SYS	SYS	SYS	SYS	SYS	
COM 0 (red/ green)	RUN	RUN	MS	RUN	BS	SF	STA	S	RUN	RUN	
COM 1 (red/ green)	ERR	ERR	NS	ERR	BE	BF	ERR	-	ERR	ERR	
RJ45 Ch0	green	LINK	L/A IN	LINK	LINK	L/A	LINK	L/A	L/A	LINK IN	L/A
	yellow	ACT	-	ACT	ACT	-	RX/TX	-	-	ACT IN	-
RJ45 Ch1	green	LINK	L/A OUT	LINK	LINK	L/A	LINK	L/A	L/A	LINK OUT	L/A
	yellow	ACT	-	ACT	ACT	-	RX/TX	-	-	ACT OUT	-

Table 34: LED Labeling depending of the loaded Firmware, CIFX 70E-RE, CIFX 70E-REMR

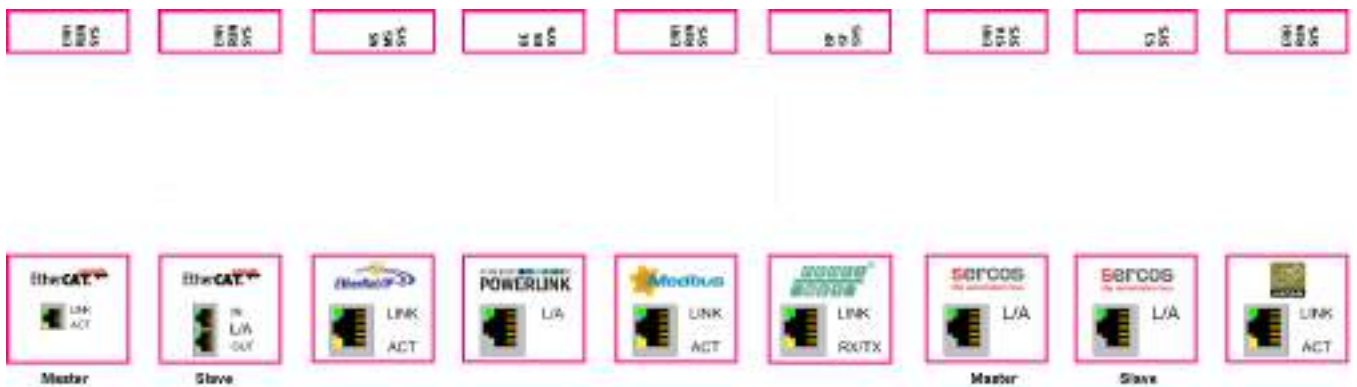

Figure 58: Front Plate Stickers for CIFX 100EH-RE/CUBE

## 6.2 Installing PC Card cifX PCI, PCIe, Low Profile PCIe

1. Adhere to the necessary safety precautions for components that are vulnerable with electrostatic discharge.

### NOTICE

#### Electrostatically sensitive Devices

- To prevent damage to the PC and the PC card cifX, make sure, that the PC card cifX is grounded via the endplate and the PC and make sure, that you are discharged when you install/uninstall the PC card cifX.
2. Fix front plate sticker (only for CIFX 50-RE, CIFX 50E-RE, CIFX 50E-RE\ET, CIFX 70E-RE, CIFX 70E-RE\MR or CIFX 100EH-RE\CUBE).
    - Use the sticker according to the device and firmware and glue it on the front of the PC card cifX (see section *Fix Front Plate Sticker* on page 96).
  3. Set Slot Number (Card ID).
    - For devices with **Rotary Switch Slot Number (Card ID)** set the **Slot Number (Card ID)**: (Value 0 or a value from 1 to 9), (see section *Rotary Switch for Slot Number (Card ID)* on page 141).
  4. Take safety precautions.

### WARNING

#### Lethal Electrical Shock caused by parts with more than 50V!

- Disconnect the power plug of the PC or of the connecting device.
- Make sure, that the power supply is off at the PC or at the connecting device.

### NOTICE

#### Device Damage!

- The PC card CIFX 100EH-RE\CUBE may not be installed in standard PCs. The pin assignment of the PCI Express bus does not meet the standard [bus spec 3]. By consequence malfunction can occur at the PCI express bus.
  - Install the PC card CIFX 100EH-RE\CUBE exclusively in KEBA KeControl industry PCs series CP 3XX (Cube).
5. Open cabinet.
    - Open the cabinet of the PC or of the connecting device.
  6. Install PC card cifX.
    - Plug the PC card cifX **PCI** into a free PCI slot.
    - Plug the PC card cifX **PCI Express** or **Low Profile PCI Express** into a free PCI express slot.
    - Fix the PC card cifX using the hole intended.

After this:

7. Close cabinet.

- Close the cabinet of the PC or connecting device.
8. Plug the connecting cable to the Master or Slave.
- Note for the PC cards cifX Real-Time Ethernet::



---

**Note:** The RJ45 socket is only for use in LAN, not for telecommunication circuits. For further information refer to section *Ethernet Interface* on page 135.

---

- Plug the connecting cable from the PC card cifX to the PC card Master or Slave.
9. Connect the PC or the connecting device to the power supply and switch it on.
- Connect the PC or the connecting device to the power supply.
  - Switch on the PC or the connecting device.

## 6.3 Uninstalling the PC Card cifX PCI, PCIe, Low Profile PCIe

1. Take safety precautions.



### Lethal Electrical Shock caused by parts with more than 50V!

- Disconnect the power plug of the PC or of the connecting device.
- Make sure, that the power supply is off at the PC or at the connecting device.



### Electrostatically sensitive Devices

- To prevent damage to the PC and the PC card cifX, make sure, that the PC card cifX is grounded via the endplate and the PC and make sure, that you are discharged when you install/uninstall the PC card cifX.
2. Remove the connecting cable to the Master or Slave.
- Remove the connecting cable between the PC card cifX to be replaced and the PC card Master or Slave.
3. Open cabinet.
- Open the cabinet of the PC or of the connecting device.
4. Uninstall PC card cifX.
- Loosen the PC card cifX.
  - Remove the PC card cifX from the **PCI** slot or from the **PCI express** slot.

After this:

5. Close cabinet.
- Close the cabinet of the PC or connecting device.

## 7 Troubleshooting

### 7.1 Instructions for Problem Solving

In case of any error, follow the instructions for problem solving given here:

#### General

- Check the PC card cifX operating requirements according to the requirements given in section *Requirements for Operation* on page 45.

**SYS and COM Status LEDs** Troubleshooting of the system is done by examining the LEDs behaviour. The PC cards cifX have depending by card type two or three bicolor status LEDs, which inform the user about the communication state of the device.

- The **SYS** LED shows the common system status of the device. It can be yellow or green ON or it can blink green/yellow.
- The **COM** LEDs display the status of the Real-Time Ethernet or fieldbus communication. Depending by protocol and state, the LEDs can be ON or flash cyclic or acyclic in green or red (or orange).

If the LED SYS is solid green and the LED COM or COM0 is static green, the PC card cifX is in operational state, the Master is in data exchange with the connected Slaves and the communication is running without fault. The meaning of the LEDs is described in chapter *LED Descriptions* beginning from page 102.

#### LINK-LED (for PC cards cifX Real-Time Ethernet)

- Check using the LINK LED's status whether a connection to the Ethernet is established. Therefore use the description on the LINK LED in the chapter *LED Descriptions* beginning from page 102.

#### Cable

- Check that the pin assignment of the cable is correct. I. e., the cable by which you connect the PC card cifX to the PC card Master or Slave.

#### Firmware CC-Link IE Field Slave

- Use the PC cards CIFX 50E-CCIES or CIFX 70E-CCIES only together with the CC-Link IE Field Slave firmware and do not use this firmware for any other cards.

#### Configuration

- Check the configuration in the Master device and the Slave device. The configuration has to match.

#### Diagnosis

Via **Online > Diagnosis** (for SYCON.net) or **netX Configuration Tool > Diagnostics** (for netX Configuration Tool) the diagnostic information of the device is shown. The shown diagnostic information depends on the used protocol.



Further information about the device diagnosis and its functions you find in the operating instruction manual of the corresponding Real-Time Ethernet or fieldbus system.

## 8 LED Descriptions

The LEDs will be used to indicate status information of the PC card cifX. Each LED has a specific function during Run, configuration download and error indications. The descriptions hereafter show the reaction of each LED for the PC card cifX during these states.

### 8.1 Overview LEDs Real-Time Ethernet Systems



**Note:** The meaning of the communication status LEDs and of the Ethernet LEDs at the device is defined by the loaded firmware of the predocol.

LED Naming in the Device Drawing	EtherCAT Master	EtherCAT Slave	EtherNet/IP	Open-Modbus/TCP	POWERLINK	PROFINET IO	Sercos Master	Sercos Slave	VARAN	CC-Link IE Field Basic	
<b>SYS</b> (System Status) ● ● (yellow/green)	<b>SYS</b>	<b>SYS</b>	<b>SYS</b>	<b>SYS</b>	<b>SYS</b>	<b>SYS</b>	<b>SYS</b>	<b>SYS</b>	<b>SYS</b>	<b>SYS</b>	
<b>COM 0</b> (Communication Status)	<b>RUN</b> ● (green)	<b>RUN</b> ● (green)	<b>MS</b> ● ● (red/green)	<b>RUN</b> ● (green)	<b>BS</b> ● (green)	<b>SF</b> ● (red)	<b>STA</b> ● (green)	<b>S</b> ● ● (red/green/orange)	<b>RUN</b> ● (green)	<b>RUN</b> ● (green)	
<b>COM 1</b> (Communication Status)	<b>ERR</b> ● (red)	<b>ERR</b> ● (red)	<b>NS</b> ● ● (red/green)	<b>ERR</b> ● (red)	<b>BE</b> ● (red)	<b>BF</b> ● (red)	<b>ERR</b> ● (red)	-	<b>ERR</b> ● (red)	<b>ERR</b> ● (red)	
Ethernet Ch0	● (green)	<b>LINK</b>	<b>L/A IN</b>	<b>LINK</b>	<b>LINK</b>	<b>L/A</b>	<b>LINK</b>	<b>L/A</b>	<b>L/A</b>	<b>LINK IN</b>	<b>L/A</b>
	● (yellow)	<b>ACT</b>	-	<b>ACT</b>	<b>ACT</b>	-	<b>RX/TX</b>	-	-	<b>ACT IN</b>	-
Ethernet Ch1	● (green)	-	<b>L/A OUT</b>	<b>LINK</b>	<b>LINK</b>	<b>L/A</b>	<b>LINK</b>	<b>L/A</b>	<b>L/A</b>	<b>LINK OUT</b>	<b>L/A</b>
	● (yellow)	-	-	<b>ACT</b>	<b>ACT</b>	-	<b>RX/TX</b>	-	-	<b>ACT OUT</b>	-

Table 35: Overview LEDs Real-Time Ethernet Systems

LED	Name	Meaning
System Status	SYS	System Status
Kommunikationsstatus	COM	Communication Status
	RUN	Run
	ERR	Error
	STA	Status
	MS	Module Status
	NS	Network Status
	BS	Bus Status
	BE	Bus Error
	SF	System Failure
	BF	Bus Failure
	S	Status / Error
	Ethernet	LINK, L
ACT, A		Activity
L/A		Link/Activity
L/A IN		Link/Activity Input
L/A OUT		Link/Activity Output
LINK IN		Link Input
LINK OUT		Link Output
ACT IN		Activity Input
ACT OUT		Activity Output
RX/TX		Receive/Transmit

Table 36: LED Names



**Note:** The PC cards CIFX 50E-CCIES and CIFX 70E-CCIES are based on their own hardware and are equipped with several LEDs that are different from those of the PC cards cifX RE variants. The descriptions of the CC-Link IE Field slave LEDs are given in the *CC-Link IE Field Slave* section on page 106.

## 8.2 Overview LEDs Fieldbus Systems

LED	PROFIBUS DP (1 Duo LED)	PROFIBUS MPI (1 Duo LED)	CANopen (1 Duo LED)	DeviceNet (1 Duo LED)	CC-Link (Slave) (2 LEDs)
System Status ● ● (yellow/green)	<b>SYS</b>	<b>SYS</b>	<b>SYS</b>	<b>SYS</b>	<b>SYS</b>
Communication Status	<b>COM</b> ● ● (red/green)	<b>COM</b> ● (green)	<b>CAN</b> ● ● (red/green)	<b>MNS</b> ● ● (red/green)	<b>L RUN</b> ● (green) <b>L ERR</b> ● (red)

Table 37: Overview LEDs by Fieldbus System for 1 Channel Devices

LED	PROFIBUS D (1 Duo LED/ channel)	CANopen (1 Duo LED/ channel)	DeviceNet (1 Duo LED/ channel)	AS-Interface (Master) (1 Duo LED/ channel)
System Status ● ● (yellow/green)	<b>SYS</b>	<b>SYS</b>	<b>SYS</b>	<b>SYS</b>
Communication Status ● ● (red/green) Channel X1 (SYCONnet: Ch0) Channel X2 (SYCONnet: Ch1)	<b>COM0</b> <b>COM1</b>	<b>CAN0</b> <b>CAN1</b>	<b>MNS0</b> <b>MNS1</b>	<b>COM1</b> <b>COM2</b>

Table 38: Overview LEDs by Fieldbus System for 2 Channel Devices

LED	Name	Meaning
System Status	SYS	System Status
Communication Status	COM	Communication Status
	CAN	CANopen Status
	MNS	Module Network Status
	L RUN / L ERR	Status Run / Status Error

Table 39: LED Names



\* Descriptions for 2-Communication Status LEDs of PROFIBUS DP Master and Slave devices as well as of CANopen Master and Slave devices of earlier device revisions are included in the user manual for PC cards cifX fieldbus up to manual revision 23.

## 8.3 System LED

The System Status LED **SYS** can assume the states described below.





LED	Color	State	Meaning
SYS	<b>Duo LED yellow/green</b>		
	 (green)	On	Operating System running
	 (green/yellow)	Blinking, cyclic	Second stage bootloader is waiting for firmware.
	 (yellow)	On	Bootloader netX (= romloader) is waiting for second stage bootloader.
	 (off)	Off	Power supply for the device is missing or hardware defect.

Table 40: System Status LED States



## 8.4 CC-Link IE Field Basic Slave

For the CC-Link IE Field Basic Slave protocol, the communication LEDs **RUN** and **ERR** as well as the Ethernet LED **L/A** can assume the states described below.











LED	Color	State	Meaning
<b>RUN</b> (Run) General name: <b>COM0</b>	<b>Duo LED red/green</b>		
	 (green)	On	Station in operation and cyclic transmission in progress.
	 (green)	Blinking (2.5 Hz)	Station in operation and cyclic transmission stopped.
	 (green)	Flickering (10 Hz)	Station not configured.
	 (off)	Off	Station is disconnected.
<b>ERR</b> (Error) General name: <b>COM1</b>	 (red)	On	Communication error.
	 (red)	Triple Flash	DPM watchdog has expired.
	 (off)	Off	Station is disconnected.
<b>L/A</b> Ch0 & Ch1	<b>LED green</b>		
	 (green)	On	<b>Link:</b> The station is linked to the Ethernet, but does not send/receive Ethernet frames.
	 (green)	Flickering (load dependent)	<b>Activity:</b> The station is linked to the Ethernet and sends/receives Ethernet frames.
	 (off)	Off	The station has no link to the Ethernet.
Ch0 & Ch1	<b>LED yellow</b>		
	 (off)	Off	This LED is not used.

Table 41: LED states for the CC-Link IE Field Basic Slave

LED State	Definition
Triple Flash	The indicator shows a sequence of three short flashes (each 200 ms), separated by a short off phase (200 ms). The sequence is finished by a long off phase (1,000 ms).
Blinking (2.5 Hz)	The indicator turns on and off with a frequency of 2.5 Hz: "on" for 200 ms, followed by "off" for 200 ms.
Flickering (10 Hz)	The indicator turns on and off with a frequency of 10 Hz: "on" for 50 ms, followed by "off" for 50 ms.
Flickering (load dependent)	The indicator turns on and off with a frequency of approximately 10 Hz to indicate high Ethernet activity: on for approximately 50 ms, followed by off for 50 ms. The indicator turns on and off in irregular intervals to indicate low Ethernet activity.

Table 42: LED state definitions for the CC-Link IE Field Basic Slave protocol

## 8.5 CC-Link IE Field Slave

For the CC-Link IE Field Slave protocol, the communication LEDs **RUN**, **RD**, **SD**, **D-LINK**, **ERR**, **USER1** and **USER2** as well as the Ethernet-LEDs **LINK0** or **L-ERR0** and **LINK1** or **L-ERR1** can assume the states described below. This description is valid from CC-Link IE Field Slave stack version V1.1.



















LED	Color	State	Meaning
<b>RUN</b>	<b>LED green:</b> Indicates the operation status.		
	 (green)	On	Operating normally (depending from the netX firmware "BusOn" status)
	 (off)	Off	A watchdog timer error or a hardware failure has occurred.
<b>RD</b>	<b>LED green:</b> Displays the reception status of the data.		
	 (green)	On	Receiving data.
	 (off)	Off	Data not received.
<b>SD</b>	<b>LED green:</b> Displays the sending status of the data.		
	 (green)	On	Sending data.
	 (off)	Off	Data not sent.
<b>D-LINK</b>	<b>LED yellow:</b> Indicates the status of the data link.		
	 (yellow)	On	Data link in operation (cyclic transmission in progress)
	 (yellow)	Blinking	Data link in operation (cyclic transmission stopped)
	 (off)	Off	Data link not performed (disconnected)
<b>ERR</b>	<b>LED red:</b> Indicates the CP520 error status.		
	 (red)	On	Error in own station
	 (off)	Off	Normal operation
<b>USER1</b>	<b>LED yellow:</b> Indicates an user-defined status 1.		
	 (yellow)	On	Currently not used
	 (off)	Off	Currently not used
<b>USER2</b>	<b>LED yellow:</b> Indicates an user-defined status 2.		
	 (yellow)	On	Currently not used
	 (off)	Off	Currently not used
<b>LINK0, LINK1</b> Ch0 & Ch1	<b>LED green</b>		
	 (green)	On	Link up
	 (Off)	Off	Link down
<b>L-ERR0, L-ERR1</b> Ch0 & Ch1	<b>LED yellow</b>		
	 (yellow)	On	Abnormal data received or loopback in progress
	 (Off)	Off	Normal data received or loopback not performed

Table 43: LED states for the CC-Link IE Field Slave protocol

Name	Meaning
RUN	Run
RD	Reception status of the data
SD	Sending status of the data
D-LINK	Data link

Name	Meaning
ERR	Error
USER	User-defined status
LINK	Link status
L-ERR	Error status of the received data, the line and the loopback

Table 44: LED Names CC-Link IE Field Slave protocol

## 8.6 EtherCAT Master V3

For the EtherCAT Master protocol, the communication LEDs **RUN** and **ERR** as well as the Ethernet LEDs **LINK** and **ACT** can assume the states described below. This description is valid from stack version V3.0.











LED	Color	State	Meaning
<b>RUN</b> General name: <b>COM 0</b>	<b>Duo LED red/green</b>		
	 (off)	Off	<b>INIT:</b> The device is in state INIT.
	 (green)	Blinking (2,5 Hz)	<b>PRE-OPERATIONAL:</b> The device is in PRE-OPERATIONAL state.
	 (green)	Flickering (10 Hz)	<b>BOOT:</b> Device is in Boot mode.
	 (green)	Single flash	<b>SAFE-OPERATIONAL:</b> The device is in SAFE-OPERATIONAL state.
	 (green)	On	<b>OPERATIONAL:</b> The device is in OPERATIONAL state.
<b>ERR</b> General name: <b>COM 1</b>	<b>Duo-LED red/green</b>		
	 (off)	Off	Master has no errors.
	 (red)	On	Master has detected a communication error. The error is indicated in the DPM.
<b>LINK</b> Ch0	<b>LED green</b>		
	 (green)	On	The device is linked to the Ethernet.
	 (off)	Off	The device has no link to the Ethernet.
<b>ACT</b> Ch0	<b>LED yellow</b>		
	 (yellow)	Flickering (load dependant)	The device sends/receives Ethernet frames.
	 (off)	Off	The device does not send/receive Ethernet frames.

Table 45: LED states for the EtherCAT Master protocol

LED State	Definition
Blinking (2,5 Hz)	The indicator turns on and off with a frequency of 2,5 Hz: "on" for 200 ms, followed by "off" for 200 ms.
Flickering (10 Hz)	The indicator turns on and off with a frequency of 10 Hz: "on" for 50 ms, followed by "off" for 50 ms.
Single flash	The indicator shows one short flash (200 ms) followed by a long "off" phase (1,000 ms).
Flickering (load dependant)	The indicator turns on and off with a frequency of approximately 10 Hz to indicate high Ethernet activity: on for approximately 50 ms, followed by off for 50 ms. The indicator turns on and off in irregular intervals to indicate low Ethernet activity.

Table 46: LED state definitions for the EtherCAT Master protocol

## 8.7 EtherCAT Master V4

For the EtherCAT Master protocol, the communication LEDs **RUN** and **ERR** as well as the Ethernet LEDs **LINK** and **ACT** can assume the states described below. This description is valid from stack version V4.0.



















LED	Color	State	Meaning
<b>RUN</b> General name: <b>COM 0</b>	<b>Duo LED red/green</b>		
	 (off)	Off	<b>INIT:</b> The device is in state INIT.
	 (green)	Blinking (2,5 Hz)	<b>PRE-OPERATIONAL:</b> The device is in PRE-OPERATIONAL state.
	 (green)	Flickering (10 Hz)	The device is not configured.
	 (green)	Single flash	<b>SAFE-OPERATIONAL:</b> The device is in SAFE-OPERATIONAL state.
	 (green)	On	<b>OPERATIONAL:</b> The device is in OPERATIONAL state.
<b>ERR</b> General name: <b>COM 1</b>	<b>Duo-LED red/green</b>		
	 (off)	Off	Master has no errors.
	 (red)	Single flash	Bus Sync error threshold
	 (red)	Double flash	Internal Stop of the bus cycle
	 (red)	Triple Flash	DPM watchdog has expired.
	 (red)	Quadruple Flash	No Master license present in the device.
	 (red)	Blinking (2,5 Hz)	Error in the configuration database.
	 (red)	Single Flickering	Channel Init was executed at the Master. Remarks: Transient error so can happen to be not visible at all.
	 (red)	Double Flickering	Slave is missing. Unconfigured Slave No matching mandatory slave list No bus connected
	 (red)	Flickering (10 Hz)	Boot-up was stopped due to an error.
<b>LINK</b> Ch0	<b>LED green</b>		
	 (green)	On	<b>Link:</b> The device is linked to the Ethernet, but does not send/receive Ethernet frames.
	 (green)	Flickering (load dependent)	<b>Activity:</b> The device is linked to the Ethernet and sends/receives Ethernet frames.
	 (off)	Off	The device has no link to the Ethernet.
<b>ACT</b> Ch0	<b>LED yellow</b>		
	 (off)	Off	This LED is not used.

Table 47: LED states for the EtherCAT Master protocol

LED State	Definition
Single flash	The indicator shows one short flash (200 ms) followed by a long "off" phase (1,000 ms).
Double flash	The indicator shows a sequence of two short flashes (each 200 ms), separated by a short off phase (200 ms). The sequence is finished by a long off phase (1,000 ms).
Triple Flash	The indicator shows a sequence of three short flashes (each 200 ms), separated by a short off phase (200 ms). The sequence is finished by a long off phase (1,000 ms).

LED State	Definition
Quadruple Flash	The indicator shows a sequence of four short flashes (each 200 ms), separated by a short off phase (200 ms). The sequence is finished by a long off phase (1,000 ms).
Blinking (2,5 Hz)	The indicator turns on and off with a frequency of 2,5 Hz: "on" for 200 ms, followed by "off" for 200 ms.
Single Flickering	The indicator is switched on and off once: 'on' for 50 ms, followed by 'off' for 500 ms.
Double Flickering	The indicator is switched on and off and on once: 'on' / 'off' / 'on' each for approximately 50 ms, followed by 'off' for 500 ms.
Flickering (10 Hz)	The indicator turns on and off with a frequency of 10 Hz: "on" for 50 ms, followed by "off" for 50 ms.
Flickering (load dependant)	The indicator turns on and off with a frequency of approximately 10 Hz to indicate high Ethernet activity: on for approximately 50 ms, followed by off for 50 ms. The indicator turns on and off in irregular intervals to indicate low Ethernet activity.

*Table 48: LED state definitions for the EtherCAT Master protocol*

## 8.8 EtherCAT Slave

For the EtherCAT Slave protocol, the communication LEDs **RUN** and **ERR** as well as the Ethernet-LED **L/A IN** or **L/A OUT** can assume the states described below. This description is valid from stack version V2.5 (V2).













LED	Color	State	Meaning
<b>RUN</b> General name: <b>COM 0</b>	<b>Duo LED red/green</b>		
	 (off)	Off	<b>INIT:</b> The device is in state INIT.
	 (green)	Blinking (2,5 Hz)	<b>PRE-OPERATIONAL:</b> The device is in PRE-OPERATIONAL state.
	 (green)	Single flash	<b>SAFE-OPERATIONAL:</b> The device is in SAFE-OPERATIONAL state.
	 (green)	On	<b>OPERATIONAL:</b> The device is in OPERATIONAL state.
<b>ERR</b> General name: <b>COM 1</b>	<b>Duo-LED red/green</b>		
	 (off)	Off	<b>No error:</b> The EtherCAT communication of the device is in working condition.
	 (red)	Blinking (2,5 Hz)	<b>Invalid configuration:</b> General Configuration Error Possible reason: State change commanded by master is impossible due to register or object settings.
	 (red)	Single Flash	<b>Local error:</b> Slave device application has changed the EtherCAT state autonomously. Possible reason 1: A host watchdog timeout has occurred. Possible reason 2: Synchronization Error, device enters Safe-Operational automatically.
	 (red)	Double Flash	<b>Application watchdog timeout:</b> An application watchdog timeout has occurred. Possible reason: Sync Manager Watchdog timeout.
<b>L/A IN</b> or <b>L/A OUT</b>	<b>LED green</b>		
	 (green)	On	<b>Link:</b> The device is linked to the Ethernet, but does not send/receive Ethernet frames.
	 (green)	Flickering (load dependant)	<b>Activity:</b> The device is linked to the Ethernet and sends/receives Ethernet frames.
	 (off)	Off	The device has no link to the Ethernet.
	<b>LED yellow</b>		
	 (off)	Off	This LED is not used.













Table 49: LED states for the EtherCAT Slave protocol

LED State	Beschreibung
Blinking (2,5 Hz)	The indicator turns on and off with a frequency of 2,5 Hz: "on" for 200 ms, followed by "off" for 200 ms.
Single flash	The indicator shows one short flash (200 ms) followed by a long "off" phase (1,000 ms).
Double flash	The indicator shows a sequence of two short flashes (each 200 ms), separated by a short off phase (200 ms). The sequence is finished by a long off phase (1,000 ms).
Flickering (load dependant)	The indicator turns on and off with a frequency of approximately 10 Hz to indicate high Ethernet activity: on for approximately 50 ms, followed by off for 50 ms. The indicator turns on and off in irregular intervals to indicate low Ethernet activity.

Table 50: LED state definitions for the EtherCAT Slave protocol

## 8.9 EtherNet/IP Scanner (Master)

For the EtherNet/IP Scanner protocol, the communication LEDs **MS** and **NS** as well as the Ethernet LEDs **LINK** and **ACT** can assume the states described below. This description is valid from stack version V2.6.

LED	Color	State	Meaning
<b>MS</b> (Module status) General name: <b>COM 0</b>	<b>Duo-LED red/green</b>		
	 (green)	On	<b>Device operational:</b> The device is operating correctly.
	 (green)	Flashing (1 Hz)	<b>Standby:</b> The device has not been configured.
		Flashing (green/red/green)	<b>Self-test:</b> The device is performing its power-up testing. The module status indicator test sequence occurs before the network status indicator test sequence, according to the following sequence: <ul style="list-style-type: none"> <li>• Network status LED off.</li> <li>• Module status LED turns green for approximately 250 ms, turns red for approximately 250 ms, and again turns green (and holds that state until the power-up test has completed).</li> <li>• Network status LED turns green for approximately 250 ms, turns red for approximately 250 ms, and then turns off (and holds that state until the power-up test has completed).</li> </ul>
	 (red)	Blinking (1 Hz)	<b>Major recoverable fault:</b> The device has detected a major recoverable fault. E.g., an incorrect or inconsistent configuration can be considered a major recoverable fault.
	 (red)	On	<b>Major unrecoverable fault:</b> The device has detected a major unrecoverable fault.
	 (Off)	Off	<b>No power:</b> The device is powered off.
<b>NS</b> (Network-status) General name: <b>COM 1</b>	<b>Duo-LED red/green</b>		
	 (green)	On	<b>Connected:</b> An IP address is configured, at least one CIP connection (any transport class) is established, and an Exclusive Owner connection has not timed out.
	 (green)	Flashing (1 Hz)	<b>No connections:</b> An IP address is configured, but no CIP connections are established, and an Exclusive Owner connection has not timed out.
		Flashing (green/red/off)	<b>Self-test:</b> The device is performing its power-up testing. Refer to description for module status LED self-test.
	 (red)	Blinking (1 Hz)	<b>Connection timeout:</b> An IP address is configured, and an Exclusive Owner connection for which this device is the target has timed out. The network status indicator returns to steady green only when all timed out Exclusive Owner connections are reestablished.
	 (red)	On	<b>Duplicate IP:</b> The device has detected that its IP address is already in use.
	 (Off)	Off	<b>Not powered, no IP address:</b> The device does not have an IP address (or is powered off).





LED	Color	State	Meaning
<b>LINK</b> Ch0 & Ch1	<b>LED green</b>		
	 (green)	On	The device is linked to the Ethernet.
	 (Off)	Off	The device has no link to the Ethernet.
<b>ACT</b> Ch0 & Ch1	<b>LED yellow</b>		
	 (yellow)	Flickering (load de- pendant)	The device sends/receives Ethernet frames.
	 (Off)	Off	The device does not send/receive Ethernet frames.

Table 51: LED states for the EtherNet/IP Scanner protocol

















LED state	Definition
Blinking (1 Hz)	The indicator turns on and off with a frequency of 1 Hz: "on" for 500 ms, followed by "off" for 500 ms.
Flickering (load dependant)	The indicator turns on and off with a frequency of approximately 10 Hz to indicate high Ethernet activity: on for approximately 50 ms, followed by off for 50 ms. The indicator turns on and off in irregular intervals to indicate low Ethernet activity.

Table 52: LED state definitions for the EtherNet/IP Scanner protocol



## 8.10 EtherNet/IP Adapter (Slave)

For the EtherNet/IP Adapter protocol, the communication LEDs **MS** and **NS** as well as the Ethernet LEDs **LINK** and **ACT** can assume the states described below. This description is valid from stack version V2.7 (V2) or from V3.0.

LED	Color	State	Meaning
<b>MS</b> (Module status) General name: <b>COM 0</b>	<b>Duo-LED red/green</b>		
	 (green)	On	<b>Device operational:</b> The device is operating correctly.
	 (green)	Flashing (1 Hz)	<b>Standby:</b> The device has not been configured.
	  	Flashing (green/red/green)	<b>Self-test:</b> The device is performing its power-up testing. The module status indicator test sequence occurs before the network status indicator test sequence, according to the following sequence: <ul style="list-style-type: none"> <li>• Network status LED off.</li> <li>• Module status LED turns green for approximately 250 ms, turns red for approximately 250 ms, and again turns green (and holds that state until the power-up test has completed).</li> <li>• Network status LED turns green for approximately 250 ms, turns red for approximately 250 ms, and then turns off (and holds that state until the power-up test has completed).</li> </ul>
	 (red)	Blinking (1 Hz)	<b>Major recoverable fault:</b> The device has detected a major recoverable fault. E.g., an incorrect or inconsistent configuration can be considered a major recoverable fault.
	 (red)	On	<b>Major unrecoverable fault:</b> The device has detected a major unrecoverable fault.
	 (Off)	Off	<b>No power:</b> The device is powered off.
<b>NS</b> (Network-status) General name: <b>COM 1</b>	<b>Duo-LED red/green</b>		
	 (green)	On	<b>Connected:</b> An IP address is configured, at least one CIP connection (any transport class) is established, and an Exclusive Owner connection has not timed out.
	 (green)	Flashing (1 Hz)	<b>No connections:</b> An IP address is configured, but no CIP connections are established, and an Exclusive Owner connection has not timed out.
	  	Flashing (green/red/off)	<b>Self-test:</b> The device is performing its power-up testing. Refer to description for module status LED self-test.
	 (red)	Blinking (1 Hz)	<b>Connection timeout:</b> An IP address is configured, and an Exclusive Owner connection for which this device is the target has timed out. The network status indicator returns to steady green only when all timed out Exclusive Owner connections are reestablished.
	 (red)	On	<b>Duplicate IP:</b> The device has detected that its IP address is already in use.
	 (Off)	Off	<b>Not powered, no IP address:</b> The device does not have an IP address (or is powered off).





LED	Color	State	Meaning
<b>LINK</b> Ch0 & Ch1	<b>LED green</b>		
	 (green)	On	The device is linked to the Ethernet.
	 (Off)	Off	The device has no link to the Ethernet.
<b>ACT</b> Ch0 & Ch1	<b>LED yellow</b>		
	 (yellow)	Flickering (load de- pendant)	The device sends/receives Ethernet frames.
	 (Off)	Off	The device does not send/receive Ethernet frames.

Table 53: LED states for the EtherNet/IP Adapter protocol

LED state	Definition
Blinking (1 Hz)	The indicator turns on and off with a frequency of 1 Hz: “on” for 500 ms, followed by “off” for 500 ms.
Flickering (load dependant)	The indicator turns on and off with a frequency of approximately 10 Hz to indicate high Ethernet activity: on for approximately 50 ms, followed by off for 50 ms. The indicator turns on and off in irregular intervals to indicate low Ethernet activity.

Table 54: LED state definitions for the EtherNet/IP Adapter protocol

## 8.11 Open Modbus/TCP

For the OpenModbusTCP protocol, the communication LEDs **RUN** and **ERR** as well as the Ethernet LEDs **LINK** and **ACT** can assume the states described below. This description is valid from stack version V2.5.











LED	Color	State	Meaning
<b>RUN</b> General name: COM 0	<b>Duo-LED red/green</b>		
	 (green)	On	<b>Connected:</b> OMB task has communication. At least one TCP connection is established.
	 (green)	Flashing (1 Hz)	<b>Ready, not yet configured:</b> OMB task is ready and not yet configured.
	 (green)	Flashing (5 Hz)	<b>Waiting for Communication:</b> OMB task is configured.
	 (off)	Off	<b>Not Ready:</b> OMB task is not ready.
<b>ERR</b> General name: COM 1	<b>Duo-LED red/green</b>		
	 (off)	Off	No communication error
	 (red)	Flashing (2 Hz, 25% on)	System error
	 (red)	On	Communication error active
<b>LINK</b> Ch0 & Ch1	<b>LED green</b>		
	 (green)	On	The device is linked to the Ethernet.
	 (off)	Off	The device has no link to the Ethernet.
<b>ACT</b> Ch0 & Ch1	<b>LED yellow</b>		
	 (yellow)	Flickering (load dependant)	The device sends/receives Ethernet frames.
	 (off)	Off	The device does not send/receive Ethernet frames.

Table 55: LED states for the OpenModbusTCP protocol

LED state	Definition
Flashing (1 Hz)	The indicator turns on and off with a frequency of 1 Hz: "on" for 500 ms, followed by "off" for 500 ms.
Flashing (2 Hz, 25% on)	The indicator turns on and off with a frequency of 2 Hz: "on" for 125 ms, followed by "off" for 375 ms.
Flashing (5 Hz)	The indicator turns on and off with a frequency of 5 Hz: "on" for 100 ms, followed by "off" for 100 ms.
Flickering (load dependant)	The indicator turns on and off with a frequency of approximately 10 Hz to indicate high Ethernet activity: on for approximately 50 ms, followed by off for 50 ms. The indicator turns on and off in irregular intervals to indicate low Ethernet activity.

Table 56: LED state definitions for the OpenModbusTCP protocol

## 8.12 POWERLINK Controlled Node/Slave V2, V3

For the POWERLINK Controlled Node protocol, the communication LEDs **BS** (Bus Status) and **BE** (Bus Error) as well as the Ethernet LED **L/A** can assume the states described below. This description is valid from stack version V2.1 respectively from stack version V3.0.













LED	Color	State	Meaning
<b>BS</b> (Bus Status) General name: <b>COM 0</b>	<b>Duo LED red/green</b>		
	 (green)	On	Slave is in ' <b>Operational</b> ' state
	 (green)	Triple Flash	Slave is in ' <b>ReadyToOperate</b> ' state
	 (green)	Double flash	Slave is in ' <b>Pre-Operational 2</b> ' state
	 (green)	Single flash	Slave is in ' <b>Pre-Operational 1</b> ' state
	 (green)	Flickering (10 Hz)	Slave is in ' <b>Basic Ethernet</b> ' state
	 (green)	Blinking (2,5 Hz)	Slave is in ' <b>Stopped</b> ' state
	 (off)	Off	Slave initializing
<b>BE</b> (Bus Error) General name: <b>COM 1</b>	<b>Duo LED red/green</b>		
	 (off)	Off	Slave has no error
	 (red)	On	Slave has detected an error
<b>L/A</b> Ch0 & Ch1	<b>LED green</b>		
	 (green)	On	<b>Link:</b> The device is linked to the Ethernet, but does not send/receive Ethernet frames.
	 (green)	Flickering (load dependant)	<b>Activity:</b> The device is linked to the Ethernet and sends/receives Ethernet frames.
	 (off)	Off	The device has no link to the Ethernet.
Ch0 & Ch1	<b>LED yellow</b>		
	 (off)	Off	This LED is not used.

Table 57: LED states for the POWERLINK Controlled Node protocol

LED state	Definition
Triple Flash	The indicator shows a sequence of three short flashes (each 200 ms), separated by a short off phase (200 ms). The sequence is finished by a long off phase (1,000 ms).
Double flash	The indicator shows a sequence of two short flashes (each 200 ms), separated by a short off phase (200 ms). The sequence is finished by a long off phase (1,000 ms).
Single flash	The indicator shows one short flash (200 ms) followed by a long "off" phase (1,000 ms).
Flickering (10 Hz)	The indicator turns on and off with a frequency of 10 Hz: "on" for 50 ms, followed by off for 50 ms. The red LED and the green LED are switched on alternately.
Blinking (2,5 Hz)	The indicator turns on and off phase with a frequency of 2.5 Hz: on for 200 ms, followed by off for 200 ms. The red LED and the green LED are switched on alternately.
Flickering (load dependant)	The indicator turns on and off with a frequency of approximately 10 Hz to indicate high Ethernet activity: on for approximately 50 ms, followed by off for 50 ms. The indicator turns on and off in irregular intervals to indicate low Ethernet activity.

Table 58: LED state definitions for the POWERLINK Controlled Node protocol

## 8.13 PROFINET IO-Controller V2

For the PROFINET IO-Controller protocol, the communication LEDs **SF** (system failure) and **BF** (bus failure) as well as the Ethernet LEDs **LINK** and **RX/TX** can assume the states described below. This description is valid from stack version V2.6.













LED	Color	State	Meaning
<b>SF</b> (System Failure) General name: <b>COM 0</b>	<b>Duo LED red/green</b>		
	 (off)	Off	<b>No error</b>
	 (red)	Flashing (1 Hz, 3 s)	<b>DCP signal service</b> is initiated via the bus.
	 (red)	Flashing (2 Hz)	<b>System error:</b> Invalid configuration, Watchdog error or internal error
	 (red)	On (together with SF „red ON)	<b>No valid Master license</b>
<b>BF</b> (Bus Failure) General name: <b>COM 1</b>	<b>Duo LED red/green</b>		
	 (off)	Off	<b>No error</b>
	 (red)	Flashing (2 Hz)	<b>Configuration fault:</b> Not all configured IO-Devices are connected.
	 (red)	On (together with SF „red ON“)	<b>No valid Master license</b>
	 (red)	On (together with SF „red OFF“)	<b>No Connection:</b> No Link.
<b>LINK</b> Ch0 & Ch1	<b>LED green</b>		
	 (green)	On	The device is linked to the Ethernet.
	 (off)	Off	The device has no link to the Ethernet.
<b>RX/TX</b> Ch0 & Ch1	<b>LED yellow</b>		
	 (gelb)	Flickering (load dependant)	The device sends/receives Ethernet frames.
	 (off)	Off	The device does not send/receive Ethernet frames.

Table 59: LED states for the PROFINET IO-Controller protocol

LED state	Definition
Flashing (1 Hz, 3 s)	The indicator turns on and off for 3 seconds with a frequency of 1 Hz: “on” for 500 ms, followed by “off” for 500 ms.
Flashing (2 Hz)	The indicator turns on and off with a frequency of 2 Hz: “on” for 250 ms, followed by “off” for 250 ms.
Flickering (load dependant)	The indicator turns on and off with a frequency of approximately 10 Hz to indicate high Ethernet activity: on for approximately 50 ms, followed by off for 50 ms. The indicator turns on and off in irregular intervals to indicate low Ethernet activity.

Table 60: LED state definitions for the PROFINET IO-Controller protocol

## 8.14 PROFINET IO Controller V3

For the PROFINET IO Controller protocol, the system status LED **SYS**, the communication LEDs **SF** (system failure) and **BF** (bus failure), as well as the Ethernet LEDs **LINK** and **RX/TX** can assume the states described below. This description is valid from stack version V3.0.







<b>SYS</b>	<b>SF</b>	<b>BF</b>	<b>Meaning</b>
System Status yellow/green	System Failure <b>COM 0</b> red/green	Bus Failure <b>COM 1</b> red/green	LED name General LED name Colours of the Duo LEDs SYS, SF or BF
<b>Firmware and Configuration</b>			
● Off	● Off	● Off	Power supply for the device is missing or hardware defect.
● On, yellow	● Off	● Off	No second stage bootloader found in Flash memory.
 Flashing, green/yellow, cyclic	● Off	● Off	No firmware file found in Flash file system.
● On, green	● On, red	● Off	PROFINET IO Controller is not configured.
● On, green	● Off	● On, red	No Ethernet port has a link. E.g., no cable connected to any of the Ethernet ports.
● On, green	● Off	 Flashing, red, 2 Hz	PROFINET IO Controller is not online (Bus is switched to Off).
<b>PROFINET communication</b>			
● On, green	● Off or ● On, red	 Flashing, red, 1 Hz	Not all configured devices are in data exchange.
● On, green	● On, red	-	One IO Device connected to the PROFINET IO Controller reports a problem.
● On, green	● Off	● Off	All devices are in data exchange and no problem has been reported by any device.
<b>PROFINET IO Controller operation</b>			
● On, green	 Flashing, red, 1 Hz, 3 s	● Off	A PROFINET DCP Set Signal has been received.
● On, green	 Flashing, red, 2 Hz	 Flashing, red, 2 Hz	The PROFINET IO Controller has detected an address conflict. Another device in the network is using the same Name of Station or IP address as the PROFINET IO Controller. Or Watchdog error
● On, green	● On, red	● On, red	No valid Master license

Table 61: PROFINET IO Controller, SYS, COM0 and COM1 LEDs states





LED	Color	State	Meaning
LINK Ch0 & Ch1	<b>LED green</b>		
	 (green)	On	The device is linked to the Ethernet.
	 (off)	Off	The device has no link to the Ethernet.
RX/TX Ch0 & Ch1	<b>LED yellow</b>		
	 (gelb)	Flickering (load dependent)	The device sends/receives Ethernet frames.
	 (off)	Off	The device does not send/receive Ethernet frames.

Table 62: PROFINET IO Controller, Ethernet LEDs states

LED state	Definition
Flashing (1 Hz, 3 s)	The indicator turns on and off for 3 seconds with a frequency of 1 Hz: "on" for 500 ms, followed by "off" for 500 ms.
Flashing (1 Hz)	The indicator turns on and off with a frequency of 1 Hz: "on" for 500 ms, followed by "off" for 500 ms.
Flashing (2 Hz)	The indicator turns on and off with a frequency of 2 Hz: "on" for 250 ms, followed by "off" for 250 ms.
Flickering (load dependant)	The indicator turns on and off with a frequency of approximately 10 Hz to indicate high Ethernet activity: on for approximately 50 ms, followed by off for 50 ms. The indicator turns on and off in irregular intervals to indicate low Ethernet activity.

Table 63: PROFINET IO Controller, LEDs states definitions

## 8.15 PROFINET IO-Device

For the PROFINET IO-Device protocol, the communication LEDs **SF** (System Failure) and **BF** (Bus Failure) as well as the Ethernet LEDs **LINK** and **RX/TX** can assume the states described below. This description is valid from stack version V3.x (V3).











LED	Color	State	Meaning
<b>SF</b> (System Failure) General name: <b>COM 0</b>	<b>Duo LED red/green</b>		
	 (off)	Off	No error
	 (red)	Flashing (1 Hz, 3 s)	DCP signal service is initiated via the bus.
	 (red)	On	Watchdog timeout; channel, generic or extended diagnosis present; system error
<b>BF</b> (Bus Failure) General name: <b>COM 1</b>	<b>Duo LED red/green</b>		
	 (off)	Off	No error
	 (red)	Flashing (2 Hz)	No data exchange
	 (red)	On	No configuration; or low speed physical link; or no physical link
<b>LINK</b> Ch0 & Ch1	<b>LED green</b>		
	 (green)	On	The device is linked to the Ethernet.
	 (off)	Off	The device has no link to the Ethernet.
<b>RX/TX</b> Ch0 & Ch1	<b>LED yellow</b>		
	 (gelb)	Flickering (load de- pendant)	The device sends/receives Ethernet frames.
	 (off)	Off	The device does not send/receive Ethernet frames.

Table 64: LED states for the PROFINET IO-Device protocol

LED state	Definition
Flashing (1 Hz, 3 s)	The indicator turns on and off for 3 seconds with a frequency of 1 Hz: "on" for 500 ms, followed by "off" for 500 ms.
Flashing (2 Hz)	The indicator turns on and off with a frequency of 2 Hz: "on" for 250 ms, followed by "off" for 250 ms.
Flickering (load dependant)	The indicator turns on and off with a frequency of approximately 10 Hz to indicate high Ethernet activity: on for approximately 50 ms, followed by off for 50 ms. The indicator turns on and off in irregular intervals to indicate low Ethernet activity.

Table 65: LED state definitions for the PROFINET IO-Device protocol



## 8.16 Sercos Master

For the Sercos Master protocol, the communication LEDs **STA** and **ERR** as well as the Ethernet LED **L/A** can assume the states described below. This description is valid from stack version V2.1.





















LED	Color	State	Meaning
<b>STA</b> General name: <b>COM 0</b>	<b>Duo LED red/green</b>		
	 (green)	On	<b>CP4: Communication phase 4</b>
	 (green)	Triple Flash	<b>CP3: Communication phase 3</b>
	 (green)	Double flash	<b>CP2: Communication phase 2</b>
	 (green)	Single flash	<b>CP1: Communication phase 1</b>
	 (green)	Blinking (2,5 Hz)	<b>CP0: Communication phase 0</b>
	 (green)	Flickering (10 Hz)	<b>Master is not configured and is in NRT.</b> After a status change this isn't indicated again
	 (off)	Off	<b>NRT: Non Real-Time Mode</b>
<b>ERR</b> General name: <b>COM 1</b>	<b>Duo LED red/green</b>		
	 (red)	Single flash	Bus Sync error threshold
	 (red)	Double flash	Internal Stop of the bus cycle
	 (red)	Triple Flash	DPM watchdog has expired.
	 (red)	Quadruple Flash	No Master license present in the device.
	 (red)	Blinking (2,5 Hz)	Error in the configuration database.
	 (red)	Single Flickering	Channel Init was executed at the Master.
	 (red)	Double Flickering	Slave is missing.
	 (red)	Flickering (10 Hz)	Boot-up was stopped due to an error.
 (off)	Off	No error	
<b>L/A</b> Ch0 & Ch1	<b>LED green</b>		
	 (green)	On	<b>Link:</b> The device is linked to the Ethernet, but does not send/receive Ethernet frames.
	 (green)	Flickering (load dependant)	<b>Activity:</b> The device is linked to the Ethernet and sends/receives Ethernet frames.
	 (off)	Off	The device has no link to the Ethernet.
Ch0 & Ch1	<b>LED yellow</b>		
	 (off)	Off	This LED is not used.

Table 66: LED states for the Sercos Master protocol

LED state	Definition
Single flash	The indicator shows one short flash (200 ms) followed by a long "off" phase (1,000 ms).
Double flash	The indicator shows a sequence of two short flashes (each 200 ms), separated by a short off phase (200 ms). The sequence is finished by a long off phase (1,000 ms).
Triple Flash	The indicator shows a sequence of three short flashes (each 200 ms), separated by a short off phase (200 ms). The sequence is finished by a long off phase (1,000 ms).
Quadruple Flash	The indicator shows a sequence of four short flashes (each 200 ms), separated by a short off phase (200 ms). The sequence is finished by a long off phase (1,000 ms).
Blinking (2,5 Hz)	The indicator turns on and off with a frequency of 2,5 Hz: "on" for 200 ms, followed by "off" for 200 ms.
Single Flickering	The indicator is switched on and off once: 'on' for 50 ms, followed by 'off' for 500 ms.
Double Flickering	The indicator is switched on and off and on once: 'on' / 'off' / 'on' each for approximately 50 ms, followed by 'off' for 500 ms.
Flickering (10 Hz)	The indicator turns on and off with a frequency of 10 Hz: 'on' for 50 ms, followed by 'off' for 50 ms.
Flickering (load dependant)	The indicator turns on and off with a frequency of approximately 10 Hz to indicate high Ethernet activity: 'on' for approximately 50 ms, followed by 'off' for 50 ms. The indicator turns on and off in irregular intervals to indicate low Ethernet activity.

*Table 67: LED state definitions for the Sercos Master protocol*

## 8.17 Sercos Slave

For the Sercos Slave protocol, the communication LED **S** as well as the Ethernet LED **L/A** can assume the states described below. This description is valid from stack version V3.2.

















LED	Color	State	Meaning
<b>S</b> General name: <b>COM 0</b>	<b>Duo LED red/green</b> (orange = red/green simultaneously)		
	 (green)	On	<b>CP4: Communication phase 4:</b> Normal operation, no error
	 (green)	Blinking (2 Hz)	<b>Loopback:</b> The network state has changed from „fast-forward“ to „loopback“.
	 (green/orange)	Flashing (3 x green/3s)	<b>CP3: Communication phase 3</b>
		(2 x green/3s)	<b>CP2: Communication phase 2</b>
		(1 x green/3s)	<b>CP1: Communication phase 1</b>
	 (orange)	On	<b>CP0: Communication phase 0</b>
	 (orange/green)	Blinking (2 Hz)	<b>HP0:</b> Hot-plug mode
		(1 x orange/3s)	<b>HP1:</b> Hot-plug mode
		(2 x orange/3s)	<b>HP2:</b> Hot-plug mode
	 (orange)	Flashing (2 Hz)	<b>Identification:</b> Invoked by (C-DEV.Bit15 in the Device Control) Or SIP Identification Request
	 (green/red)	Flashing (2 Hz, min. 2s)	<b>MST losses <math>\geq</math> (S-0-1003/2):</b> The communication warning (S-DEV.Bit 15) is present in the Device Status.
	 (red/orange)	Flashing (2 Hz)	<b>Application error (C1D):</b> See GDP & FSP Status codes class error.
 (red)	Flashing (2 Hz)	<b>Watchdog error:</b> Application is not running	
 (red)	On	<b>Communication Error (C1D):</b> Error detected according to Sercos third generation Class 1 Diagnosis, see SCP Status codes class error.	
 (off)	Off	<b>NRT-Mode:</b> (Non Real-Time Mode) No Sercos Communication	
General name: <b>COM 1</b>	<b>Duo LED red/green</b>		
	 (off)	Off	This LED is not used.
<b>L/A</b> Ch0 & Ch1	LED green		
	 (green)	On	<b>Link:</b> The device is linked to the Ethernet, but does not send/receive Ethernet frames.
	 (green)	Flickering (load dependant)	<b>Activity:</b> The device is linked to the Ethernet and sends/receives Ethernet frames.
	 (off)	Off	The device has no link to the Ethernet.
Ch0 & Ch1	LED yellow		
	 (off)	Off	This LED is not used.

Table 68: LED state definitions for the Sercos Slave protocol

LED state	Definition
Flashing (2 Hz)	The indicator turns on and off with a frequency of 2 Hz: <i>one color:</i> On for appr. 250 ms, followed by off for appr. 250 ms. <i>two colors:</i> First color for appr. 250 ms, followed by the second color for appr. 250 ms.
Flashing (1 x green/3s) (2 x green/3s) (3 x green/3s)  (1 x orange/3s) (2 x orange/3s)	Flashing green for 250 ms, then orange on for 2 second and 750 ms. Flashing green / orange / green, each for 250 ms, then orange on for 2 seconds and 250 ms. Flashing green / orange / green / orange / green, each for 250 ms, then orange on for 1 second and 750 ms. Flashing orange for 250 ms, then green on for 2 second an 750 ms. Flashing orange / green / orange, each for 250 ms, then green on for 2 seconds and 250 ms.
Flickering (load dependant)	The indicator turns on and off with a frequency of approximately 10 Hz to indicate high Ethernet activity: "on" for approximately 50 ms, followed by "off" for 50 ms. The indicator turns on and off in irregular intervals to indicate low Ethernet activity.

Table 69: LED state definitions for the Sercos Slave protocol

## 8.18 VARAN Client (Slave)

For the VARAN Client protocol, the communication LEDs **RUN** and **ERR** as well as the Ethernet LEDs **LINK IN** and **LINK OUT** or **ACT IN** and **ACT OUT** can assume the states described below. This description is valid from stack version V1.0.











LED	Color	State	Meaning
<b>RUN</b> General name: <b>COM 0</b>	<b>Duo-LED red/green</b>		
	 (green)	On	Configured and communication is active.
	 (green)	Blinking (5 Hz)	Configured and communication is inactive.
	 (off)	Off	Not configured.
<b>ERR</b> General name: <b>COM 1</b>	<b>Duo-LED red/green</b>		
	 (off)	Off	Configured.
	 (red)	Blinking (5 Hz)	Not configured.
	 (red)	On	Communication error occurred.
<b>LINK IN</b> Ch0 & <b>LINK OUT</b> Ch1	<b>LED green</b>		
	 (green)	On	The device is linked to the Ethernet.
	 (off)	Off	The device has no link to the Ethernet.
<b>ACT IN</b> Ch0 & <b>ACT OUT</b> Ch1	<b>LED yellow</b>		
	 (yellow)	Flickering (load dependant)	The device sends/receives Ethernet frames.
	 (off)	Off	The device does not send/receive Ethernet frames.

Table 70: LED-Zustände für das VARAN-Client-Protokoll

LED state	Definition
Blinking (5 Hz)	The indicator turns on and off with a frequency of 5 Hz: "on" for 100 ms, followed by "off" for 100 ms.
Flickering (load dependant)	The indicator turns on and off with a frequency of approximately 10 Hz to indicate high Ethernet activity: on for approximately 50 ms, followed by off for 50 ms. The indicator turns on and off in irregular intervals to indicate low Ethernet activity.

Table 71: Definitionen der LED-Zustände für das VARAN-Client-Protokoll

## 8.19 PROFIBUS DP Master

For the PROFIBUS DP Master protocol, the communication status LED **COM** can assume the states described below. This description is valid from stack version V2.6.







LED	Color	State	Meaning
COM	Duo LED red/green		
	 (green)	On	Communication to all Slaves is established.
	 (green)	Flashing (5 Hz)	PROFIBUS is configured, but bus communication is not yet released from the application.
	 (green)	Flashing acyclic	No configuration or faulty configuration
	 (red)	Flashing (5 Hz)	Communication to at least one Slave is disconnected.
	 (red)	On	Communication to all Slaves is disconnected or another serious error has occurred. Redundant Mode: The active Master was not found.
 (off)	Off	Device is not switched on or network power is missing.	

Table 72: LED states for the PROFIBUS DP Master protocol

LED State	Definition
Flashing (5 Hz)	The indicator turns on and off with a frequency of 5 Hz: "on" for 100 ms, followed by "off" for 100 ms.
Flashing acyclic	The indicator turns on and off in irregular intervals.

Table 73: LED state definitions for the PROFIBUS DP Master protocol



**Note:** For 2-Channel Devices per channel works 1 communication LED.



\* Descriptions for 2-Communication Status LEDs of earlier device revisions are included in the user manual for PC cards cifX fieldbus up to manual rev. 23.

## 8.20 PROFIBUS DP Slave

For the PROFIBUS DP Slave protocol, the communication status LED **COM** can assume the states described below. This description is valid from stack version V2.7.







LED	Color	State	Meaning
COM	Duo LED red/green		
	 (green)	On	RUN, cyclic communication
	 (green)	Flashing, cyclic (2 Hz)	Master is in CLEAR state.
	 (red)	Flashing, acyclic (1 Hz)	Device is not configured.
	 (red)	Flashing, cyclic (2 Hz)	STOP, no communication, connection error
	 (red)	On	Wrong configuration at PROFIBUS DP Slave.
	 (off)	Off	Device is not switched on or power is missing. During firmware download process.

Table 74: LED states for the PROFIBUS DP Slave protocol

LED State	Definition
Flashing, acyclic (1 Hz)	The indicator turns on and off in irregular intervals, with a frequency of 1 Hz: "on" for 750 ms, followed by "off" for 250 ms.
Flashing, cyclic (2 Hz)	The indicator turns on and off with a frequency of 2 Hz: "on" for 250 ms, followed by "off" for 250 ms.

Table 75: LED state definitions for the PROFIBUS DP Slave protocol



**Note:** For 2-Channel Devices per channel works 1 communication LED.



\* Descriptions for 2-Communication Status LEDs of earlier device revisions are included in the user manual for PC cards cifX fieldbus up to manual rev. 23.

## 8.21 PROFIBUS MPI Device

For the PROFIBUS MPI protocol, the communication status LED **COM** can assume the states described below. This description is valid from stack version V2.4.





LED	Color	State	Meaning
COM	Duo LED red/green		
	 (green)	On	<b>Status:</b> The device currently holds the PROFIBUS token and is able to transfer telegrams of data.
	 (green)	Blinking (5 Hz)	<b>Status:</b> The device is configured to be a part of the PROFIBUS ring, but it must share the PROFIBUS token with other PROFIBUS-Master devices present on the PROFIBUS ring.
	 (green)	Blinking (0.5 Hz)	<b>Status:</b> Automatic baudrate detection is running
	 (off)	Off	<b>Status:</b> The device has not been integrated into the PROFIBUS ring, i.e. it has not been configured correctly or has a wrong configuration or has not received the PROFIBUS token.

Table 76: LED states for the PROFIBUS MPI protocol

LED State	Definition
Blinking (5 Hz)	The indicator turns on and off with a frequency of appr. 5 Hz: "on" for appr. 100 ms, followed by "off" for appr. 100 ms.
Blinking (0.5 Hz)	The indicator turns on and off with a frequency of appr. 0.5 Hz: "on" for appr. 1000 ms, followed by "off" for appr. 1000 ms.

Table 77: LED state definitions for the PROFIBUS MPI protocol



## 8.22 CANopen Master

For the CANopen Master protocol, the communication status LED CAN can assume the states described below. This description is valid from stack version V2.11.







LED	Color	State	Meaning
CAN	Duo-LED red/green		
	 (green)	On	<b>OPERATIONAL:</b> The device is in the OPERATIONAL state.
	 (green)	Blinking (2,5 Hz)	<b>PREOPERATIONAL:</b> The device is in the PREOPERATIONAL state.
	 (green)	Single flash	<b>STOPPED:</b> The device is in STOPPED state.
	 (red)	Single flash	<b>Warning Limit reached:</b> At least one of the error counters of the CAN controller has reached or exceeded the warning level (too many error frames).
	 (red)	Double flash	<b>Error Control Event:</b> A guard event (NMT Slave or NMT Master) or a heartbeat event (Heartbeat consumer) has occurred.
	 (red)	On	<b>Bus Off:</b> The CAN controller is in bus OFF state.
	 (aus)	Off	<b>RESET:</b> The device is executing a reset or the device has no configuration.

Table 78: LED states for the CANopen Master protocol

LED state	Definition
Blinking (2,5 Hz)	The indicator turns on and off with a frequency of 2,5 Hz: "on" for 200 ms, followed by "off" for 200 ms.
Single flash	The indicator shows one short flash (200 ms) followed by a long "off" phase (1,000 ms).
Double flash	The indicator shows a sequence of two short flashes (each 200 ms), separated by a short "off" phase (200 ms). The sequence is finished by a long "off" phase (1,000 ms).

Table 79: LED state definitions for the CANopen Master protocol



\* Descriptions for 2-Communication Status LEDs of earlier device revisions are included in the user manual for PC cards cifX fieldbus up to manual rev. 23.

## 8.23 CANopen Slave

For the **CANopen Slave protocol**, the communication status LED **CAN** can assume the states described below. This description is valid from stack version V3.4.









LED	Color	State	Meaning
<b>cifX with 1 Communication Status LED</b> (current Hardware Revision)			
<b>CAN</b>	<b>Duo LED red/green</b>		
	 (green)	On	<b>OPERATIONAL:</b> The device is in the OPERATIONAL state.
	 (green)	Blinking (2.5 Hz)	<b>PREOPERATIONAL:</b> The device is in the PREOPERATIONAL state.
	 (green)	Single flash	<b>STOPPED:</b> The device is in STOPPED state.
	 (red/green)	Flickering (10 Hz)	<b>Auto Baud Rate Detection active:</b> The Device is in the auto baud rate detection mode.
	 (red)	Single flash	<b>Warning Limit reached:</b> At least one of the error counters of the CAN controller has reached or exceeded the warning level (too many error frames).
	 (red)	Double flash	<b>Error Control Event:</b> A guard event (NMT Slave or NMT Master) or a heartbeat event (Heartbeat consumer) has occurred.
	 (red)	On	<b>Bus Off:</b> The CAN controller is in bus OFF state.
 (off)	Off	<b>RESET:</b> The device is executing a reset or the device has no configuration.	

Table 80: States of the CAN LED for the CANopen Slave protocol – 1 Communication Status LED (current Hardware Revision)

LED State	Definition
Flickering (10 Hz)	The indicator turns on and off with a frequency of 10 Hz: "on" for 50 ms, followed by "off" for 50 ms.
Blinking (2.5 Hz)	The indicator turns on and off with a frequency of 2,5 Hz: "on" for 200 ms, followed by "off" for 200 ms.
Single Flash	The indicator shows one short flash (200 ms) followed by a long "off" phase (1,000 ms).
Double Flash	The indicator shows a sequence of two short flashes (each 200 ms), separated by a short off phase (200 ms). The sequence is finished by a long "off" phase (1,000 ms).

Table 81: LED state definitions for the CANopen Slave protocol



\* Descriptions for 2-Communication Status LEDs of earlier device revisions are included in the user manual for PC cards cifX fieldbus up to manual rev. 23.

## 8.24 DeviceNet Master

For the DeviceNet Master protocol, the communication status LED **MNS** can assume the states described below. This description is valid from stack version V2.3.







LED	Color	State	Meaning
<b>MNS</b>	<b>Duo LED red/green</b>		
	 (green)	On	<b>Device operational AND on-line, connected</b> Device is online and has established all connections with all Slaves.
	 (green)	Flashing (1 Hz)	<b>Device operational AND on-line</b> Device is online and has established no connection in the established state. - Configuration missing, incomplete or incorrect.
	 (green/red/Off)	Flashing (2Hz) Green/Red/Off	<b>Self test after power on</b>
	 (red)	Flashing (1 Hz)	<b>Minor fault and/or connection time-out</b> Device is online and has established one or more connections in the established state. It has data exchange with at least one of the configured Slaves. Minor or recoverable fault: No data exchange with one of the configured Slaves. One or more Slaves are not connected. Connection timeout Minor or recoverable fault: No data exchange with one of the configured Slaves. One or more Slaves are not connected. Connection timeout. No network power present.
	 (red)	On	<b>Critical fault or critical link failure</b> Critical connection failure; device has detected a network error: duplicate MAC-ID or severe error in CAN network (CAN-bus off).
 (off)	Off	<b>Device is not powered</b> - The device may not be powered. <b>Device is not on-line and/or no network power</b> - The device has not yet completed the Dup_MAC_ID test. - The device is powered, but the network power is missing.	

Table 82: LED states for the DeviceNet Master protocol

LED state	Definition
Flashing (1 Hz)	The indicator turns on and off with a frequency of appr. 1 Hz: on for appr. 500 ms, followed by off for appr. 500 ms.
Flashing (2 Hz) green/red/off	The indicator turns on green on for 250 ms, then red on for 250 ms, then off.

Table 83: LED state definitions for the DeviceNet Master protocol

## 8.25 DeviceNet Slave

For the DeviceNet Slave protocol, the communication status LED **MNS** can assume the states described below. This description is valid from stack version V2.3.







LED	Color	State	Meaning
<b>MNS</b>	<b>Duo LED red/green</b>		
	 (green)	On	<b>Device operational AND on-line, connected</b> Device is online and has established all connections with all Slaves.
	 (green)	Flashing (1 Hz)	<b>Device operational AND on-line</b> Device is online and has established no connection in the established state. - Configuration missing, incomplete or incorrect.
	 (green/red/Off)	Flashing (2Hz) Green/Red/Off	<b>Self test after power on</b>
	 (red)	Flashing (1 Hz)	<b>Minor fault and/or connection time-out</b> Device has no connectin to the Master. Minor or recoverable fault: No data exchange with the Master. Connection timeout. No network power present.
	 (red)	On	<b>Critical fault or critical link failure</b> Critical connection failure; device has detected a network error: duplicate MAC-ID or severe error in CAN network (CAN-bus off).
 (off)	Off	<b>Device is not powered</b> - The device may not be powered. <b>Device is not on-line and/or no network power</b> - The device has not yet completed the Dup_MAC_ID test. - The device is powered, but the network power is missing.	

Table 84: LED states for the DeviceNet Slave protocol

LED state	Definition
Flashing (1 Hz)	The indicator turns on and off with a frequency of appr. 1 Hz: on for appr. 500 ms, followed by off for appr. 500 ms.
Flashing (2 Hz) green/red/off	The indicator turns on green on for 250 ms, then red on for 250 ms, then off.

Table 85: LED state definitions for the DeviceNet Slave protocol

## 8.26 AS Interface Master

For the AS-Interface Master protocol, the communication status LED **COM** can assume the states described below. This description is valid from stack version V2.3.







LED	Color	State	Meaning
COM	Duo LED red/green		
	 (green)	On	No configuration error, data exchange active
	 (green)	Flashing	Configuration error, data exchange active
	 (green)	Flickering	The communication is stopped.
	 (red/green)	Flashing	„Configuration mode“ active
	 (red)	Flashing	AS-Interface power fail
	 (red)	On	Heavy system error or hardware failure
	 (off)	Off	No configuration found for this channel

Table 86: LEDs states for the AS-Interface Master protocol

LED State	Definition
On	The indicator is constantly on.
Off	The indicator is constantly off.
Flashing	The indicator turns on and off cyclically in slowly changing phases.
Flickering	The indicator turns on and off cyclically in rapidly changing phases.

Table 87: LED state definitions for the AS-Interface Master protocol

## 8.27 CC-Link Slave

For the CC-Link Slave protocol, the communication status LEDs **L-RUN** and **L-ERR** can assume the states described below. This description is valid from stack version V2.9.





LED	Color	State	Meaning
L RUN	LED green		
	 (green)	On	After participating in the network, the device receives both refresh and polling signals or just the refresh signal normally.
	 (off)	Off	1. Before participating in the network 2. Unable to detect carrier 3. Timeout 4. Resetting hardware
L ERR	LED red		
	 (red)	Blinking	The switch setting has been changed from the setting at the reset cancellation (blinks for 0.4 sec.).
	 (red)	On	1. CRC error 2. Address parameter error (0,65 or greater is set including the number of occupied stations) 3. Baud rate switch setting error during cancellation of reset (5 or greater)
	 (off)	Off	1. Normal communication 2. Resetting hardware

Table 88: LED states for the CC-Link Slave protocol

# 9 Device Connections and Switches

## 9.1 Ethernet Interface

For the Ethernet interface use RJ45 plugs and twisted pair cable of category 5 (CAT5) or higher, which consists of 4 twisted cores and has a maximum transmission rate of 100 MBit/s (CAT5).

### 9.1.1 Ethernet Pin Assignment at the RJ45 Socket

#### 100 BASE-TX and 10 BASE-T

For the PC cards CIFX 50-RE, CIFX 50E-RE, CIFX 50E-RE\ET, CIFX 70E-RE, CIFX 70E-RE\MR, CIFX 100EH-RE\CUBE:



**Note:** The device supports the **Auto Crossover** function. Due to this fact RX and TX can be switched. The following figure shows the RJ45 standard pin assignment.

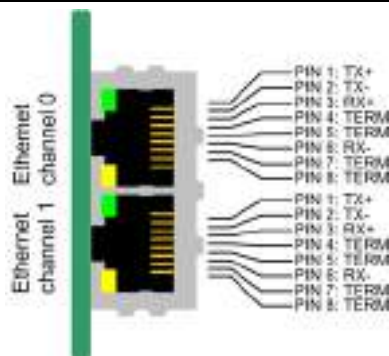

Figure 59: Ethernet Pin Assignment at the RJ45 Socket for cifX or AIFX

Pin	Signal	Meaning
1	TX+	Transmit Data +
2	TX-	Transmit Data -
3	RX+	Receive Data +
4	Term 1	Connected to each other and terminated to PE through RC circuit*
5	Term 1	
6	RX-	Receive Data -
7	Term 2	Connected to each other and terminated to PE through RC circuit*
8	Term 2	
		* Bob Smith Termination

Table 89: Ethernet Pin Assignment at the RJ45 Socket for cifX or AIFX



#### **Further Notes:**

- (1) The RJ45 socket is only for use in LAN, not for telecommunication circuits.
- (2) With loaded EtherCAT Master firmware only the RJ45 channel 0 can be used, channel 1 is deactivated. Beginning with the EtherCAT Master firmware version 3 channel 1 can be reactivated if redundancy is activated. For the Open Modbus/TCP firmware with V2.3.4.0 and higher both RJ45channels can be used.

**1000BASE-T**

For the PC cards CIFX 50E-CCIES, CIFX 70E-CCIES:

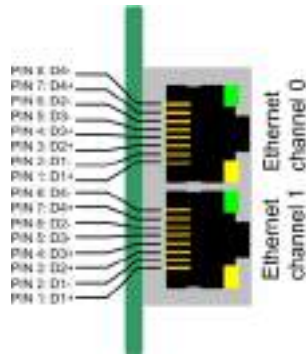

Figure 60: Ethernet Pin Assignment at the RJ45 Socket (1000 MBit/s)

Pin	Signal	Meaning
1	D1+	Transmit/receive data positive channel 1
2	D1-	Transmit/receive data negative channel 1
3	D2+	Transmit/receive data positive channel 2
4	D3+	Transmit/receive data positive channel 3
5	D3-	Transmit/receive data negative channel 3
6	D2-	Transmit/receive data negative channel 2
7	D4+	Transmit/receive data positive channel 4
8	D4-	Transmit/receive data negative channel 4
Use of Bob Smith Termination		

Table 90: Ethernet Pin Assignment at the RJ45 Socket (1000 MBit/s)



## 9.1.2 Ethernet Connection Data

	100 BASE-TX and 10 BASE-T	1000 BASE-T
<b>Medium</b>	2 x 2 Twisted-Pair copper cable, Cat5 (100 MBit/s)	Copper cable*, Cat6, Cat6A, Cat7, Cat7A, (1 Gbit/s) *Fully occupied cable (all 8 cable cores)
<b>Length of cable</b>	Max. 100 m	Max. 100 m
<b>Transmission rate</b>	10 MBit/s/100 MBit/s	1 Gbit/s

Table 91: Ethernet Connection Data

## 9.1.3 Use of Hubs and Switches

For the corresponding communication systems, the use of hubs and/or switches is either forbidden or allowed. The following table shows the acceptable use of hubs and switches by each communication system:

Communication System	Hub	Switch
<b>EtherCAT</b>	forbidden	only allowed between EtherCAT Master and first EtherCAT Slave (100 MBit/s, Full Duplex)
<b>EtherNet/IP</b>	allowed	allowed (10 MBit/s/100 MBit/s, Full or Half Duplex, Auto-Negotiation)
<b>Open Modbus/TCP</b>	allowed	allowed (10 MBit/s/100 MBit/s, Full or Half Duplex, Auto-Negotiation)
<b>POWELINK</b>	allowed	forbidden
<b>PROFINET IO</b>	forbidden	Only allowed if the switch supports 'Priority Tagging' and LLDP (100 MBit/s, Full Duplex)
<b>Sercos</b>	forbidden	forbidden
<b>VARAN*</b>	forbidden	forbidden

Table 92: Use of Hubs and Switches

\*Instead of hubs and switches VARAN uses splitter. [3]

## 9.2 PROFIBUS Interface

Isolated RS-485 interface:

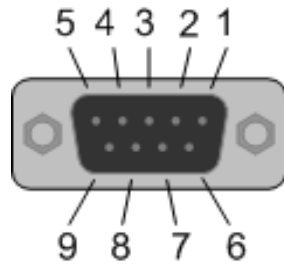

Figure 61: PROFIBUS Interface (DSub female connector, 9 pin), X400

Connection with DSub female connector	Signal	Meaning
3	RxD/TxD-P	Receive/Send Data-P respectively connection B plug
5	DGND	Reference potential
6	VP	Positive supply voltage
8	RxD/TxD-N	Receive/Send Data-N respectively connection A plug

Table 93: PROFIBUS Interface, X400

## 9.3 CANopen Interface

Isolated ISO 11898 interface:

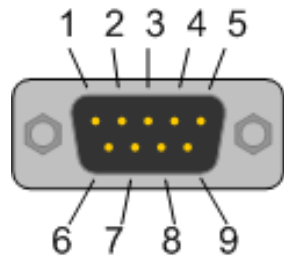

Figure 62: CANopen Interface (DSub male connector, 9 pin), X400

Connection with DSub male connector	Signal	Description
2	CAN_L	CAN_Low Bus Line
3	CAN_GND	CAN Ground
7	CAN_H	CAN High Bus Line
1, 4, 5, 6, 8, 9		<b>Do not connect!</b>

Table 94: CANopen Interface, X400

## 9.4 DeviceNet Interface

Isolated ISO 11898 interface:

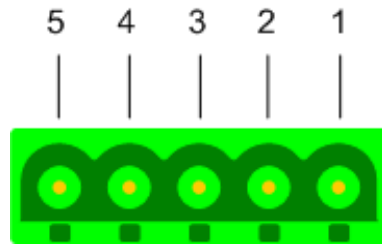

Figure 63: DeviceNet Interface (CombiCon male Connector, 5 pin), X360

Connection with CombiCon male connector	Signal	Color	Description
1	V-	Black	Reference potential DeviceNet supply voltage
2	CAN_L	Blue	CAN Low-Signal
3	Drain		Shield
4	CAN_H	White	CAN High-Signal
5	V+	Red	+24 V DeviceNet supply voltage

Table 95: DeviceNet Interface, X360

## 9.5 AS-Interface Interface

The AS-Interface Master conforms to Complete Specification 2.11 (Annex B, Version 2.0) the profile M3 (Full Extended Master).

AS-Interface interface according to IEC 364-4-41.

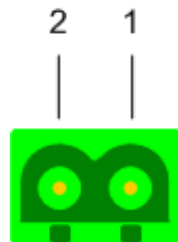

Figure 64: AS-Interface Interface (CombiCon male Connector, 2 pin)

Connection with CombiCon male connector	Signal	Description
1	AS-i +	AS-Interface positive voltage
2	AS-i -	AS-Interface negative voltage

Table 96: AS-Interface Interface

## 9.6 CC-Link Interface

Isolated RS-485 interface:

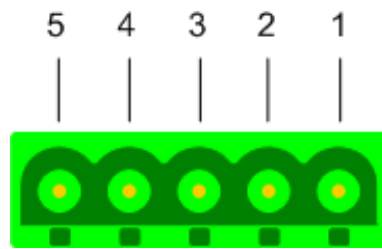

Figure 65: CC-Link Interface (CombiCon male Connector, 5 pin)

Connection with Screw terminal Connector	Signal	Meaning
1	DA	Data A
2	DB	Data B
3	DG	Data Ground
4	SLD	Shield
5	FG	Field Ground

Table 97: CC-Link Interface

## 9.7 Rotary Switch for Slot Number (Card ID)

Device revisions equipped with a **Rotary Switch Slot Number (Card ID)** are listed separately in section *Hardware: PC Cards cifX* in *Table 2* on page 10.

The **Rotary Switch Slot Number (Card ID)** serves to set the **Slot Number (Card ID)** of the PC cards cifX.

The figure below describes possible switch positions of the **Rotary Switch Slot Number (Card ID)**.



Switch Position	Meaning
0	The value 0 means: <ul style="list-style-type: none"> <li>▪ no <b>Slot Number (Card ID)</b>, i. e. the <b>Slot Number (Card ID)</b> is not used,</li> <li>▪ for downwards compatibility purposes,</li> <li>▪ characterizes PC cards cifX not equipped with a <b>Rotary Switch Slot Number (Card ID)</b>; i. e. these PC cards cifX are identified via its device number and serial number.</li> </ul>
	Example Rotary Switch Slot Number (Card ID) <b>Switch Position 0</b>
1 ... 9	corresponds to the <b>Slot Number (Card ID)</b> 1 ... 9
	Example Rotary Switch Slot Number (Card ID) <b>Switch Position 1</b>

Table 98: Rotary Switch for Slot Number (Card ID), S1

### 9.7.1 Set Slot Number (Card ID)

If the Slot Number (Card ID) shall not be used:

- set the value 0.

Or

If the Slot Number (Card ID) shall be used:

- Set a value from 1 to 9.



For further information about the **Slot Number (Card ID)** refer to section *The Function „Slot Number (Card ID)“* (page 39) or to the user manual **Software Installation for the PC Cards cifX**, sections *Slot Number (Card ID) in the cifX Device Driver Setup* and *Slot Number (Card ID) in the Configuration Software*.

### 9.7.2 Note for Device Exchange Service (Replacement Case):



**Important:** For PC cards cifX with **Rotary Switch Slot Number (Card ID)** in terms of a device exchange service (replacement case) you must set at the replacement card cifX the same **Slot Number (Card ID)** as at the preceding cifX. Then the same firmware and configuration is loaded into the replacement card cifX, as into the preceding cifX.

### 9.7.3 Rotary Switch Slot Number PC Cards cifX Low Profile

The *Table 99* below shows the **Rotary Switch Slot Number (Card ID)** of the PC cards cifX Low Profile PCI Express in switch position 0 and 1.

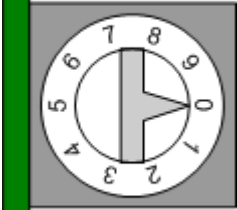
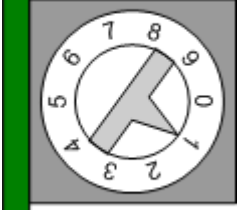
	Description
	<p>Rotary Switch Slot Number (Card ID) <b>Switch Position 0</b></p>
	<p>Rotary Switch Slot Number (Card ID) <b>Switch Position 1</b></p>

*Table 99: Rotary Switch Slot Number (Card ID) PC Cards cifX Low Profile PCI Express*

## 9.8 SYNC Connector (Pin-Assignment, Hardware/Firmware)

### 9.8.1 Pin Assignment SYNC Connector, X51 (CIFX 50 50E 70E)

Only for:

CIFX 50-RE (from hardware Rev. 3 on), CIFX 50E-RE, CIFX 50E-RE\ET, CIFX 70E-RE

Pin	Signal
1	GND
2	IO_SYNC0
3	IO_SYNC1

Table 100: Pin Assignment for SYNC Connector, X51

### 9.8.2 Pin Assignment SYNC Connector, J1 (CIFX 100EH)

Only for: CIFX 100EH-RE\CUBE.

Pin	Signal
1	IO_SYNC0
2	<i>Jumper set:</i> SYNC signal is transferred to the PCI Express Bus Pin B24*
	<i>Jumper not set:</i> static high 3.3 V (with pull-up)
3	IO_SYNC1

Table 101: Pin Assignment for SYNC Connector, J1



#### Note! \*

- If the jumper is set on Pin1-Pin2, then the **IO\_SYNC0** signal will be transferred to the PCI Express Bus X2 (pin B24).

Or

- If the jumper is set on Pin2-Pin3, then the **IO\_SYNC1** signal will be transferred to the PCI Express Bus X2 (pin B24).

Or

- If the no jumper is set, then the signal at the PCI Express Bus X2 pin B24 will be static High **3.3 V** (with pull-up).

Compare section *Pin Assignment for PCI Express Bus CIFX 100EH-RE\CUBE* on page 146.

### 9.8.3 Items on Hardware

Item	Explanation
SYNC Signal	3.3 V (LVTTTL), maximum load 6 mA
Connector	<p><u>SYNC connector, X51</u> (for the PC cards cifX, as indicated under section <i>Pin Assignment SYNC Connector, X51 (CIFX 50 50E 70E)</i> on page 143.)            Female connector, 3 pin, pitch spacing 1.25 mm (for example, the type Molex series 51021) and female crimp contacts in design (e. g. type Molex series 50079/50058)</p> <p><u>SYNC connector, J1</u> (for CIFX 100EH-RE\CUBE)            Male Connector with jumper, 3 pin, pitch spacing 2,54 mm</p>
Max. Cable Length	<p>Recommendation: Max. 50 mm</p> <p><b>Note:</b> Take EMC into consideration for the cable laying</p>

Table 102: SYNC Connector: SYNC Signal, Connector, Max. Cable Length

### 9.8.4 Items on Firmware

The firmware determines the input signal or output signal. The following table shows the meaning of the SYNC signals for each protocol.

Protocol	Signal IO_SYNC0 Input/Output	Signal IO_SYNC1 Input/Output	From Firmware Version	Remarks
EtherCAT Slave	SYNC 0 Output	SYNC 1 Output	-	Configurable
Sercos Master	External trigger to start bus cycle Input Rising edge	-	2.0.8.0	-
Sercos Slave	CON_CLK Output	DIV_CLK Output	3.0.10.0	Configurable

Table 103: Meaning of the SYNC Signals for each Protocol



## 9.9 Pin Assignment at the PCI Bus

### 9.9.1 Overview

For the PC cards cifX *PCI*, *PCI Express* and *Low Profile PCI Express* the table below gives an overview about the pin assignment at the PCI bus.

PC Card cifX	Hardware Revision	PCI Bus Type	PCI Bus [Pins]	Pin Assignment at the PCI Bus		PCI Specification					
				acc. to standard	compare section, page						
CIFX 50-RE CIFX 50-DP CIFX 50-CO CIFX 50-DN CIFX 50-CC CIFX 50-2DP CIFX 50-2DP\CO CIFX 50-2DP\DN CIFX 50-2CO CIFX 50-2CO\DN CIFX 50-2DN CIFX 50-2ASM	6 6 6 6 2 3 2 1 2 1 2 2	PCI	124	yes	-	[bus spec 1]					
CIFX 50E-RE CIFX 50E-RE\ET CIFX 50E-CCIE CIFX 50E-DP CIFX 50E-CO CIFX 50E-DN CIFX 50E-CC CIFX 50E-2DP CIFX 50E-2DP\CO CIFX 50E-2DP\DN CIFX 50E-2CO CIFX 50E-2CO\DN CIFX 50E-2DN CIFX 50E-2ASM	6 2 1 6 5 5 4 1 1 1 1 1 1 1 5						PCI Express	36	yes	-	[bus spec 2, Rev. 2.0], [bus spec 3]
CIFX 70E-RE CIFX 70E-RE\MR CIFX 50E-CCIE CIFX 70E-DP CIFX 70E-DP\MR CIFX 70E-CO CIFX 70E-COMR CIFX 70E-DN CIFX 70E-DN\MR	1 1 1 1 1 1 1 1 1 1										
CIFX 100EH-RE\CUBE	4	PCI Express	64	no	<i>Pin Assignment for PCI Express Bus CIFX 100EH-RE\CUBE, 146</i>	[bus spec 2, Rev. 2.0], [bus spec 3]					

Table 104: Pin Assignment at the PCI Bus

### 9.9.2 References PCI Specifications

No.	Specification	Revision	Version	Date	www
[bus spec 1]	PCI Local Bus Specification	2.3	-	February 21, 2003	pcisig.com
[bus spec 2]	PCI Express® Base Specification	2.0	-	January 15, 2007	
[bus spec 3]	PCI Express® Card Electromechanical Specification	2.0	-	April 11, 2007	

Table 105: References PCI Specifications

### 9.9.3 Pin Assignment for PCI Express Bus CIFX 100EH-RE\CUBE

Only for: CIFX 100EH-RE\CUBE (x1 = One Lane)<sup>2</sup>

PCI Express Bus X2 (Side B)			PCI Express Bus X1 (Side A)		
Pin	Name	Description	Pin	Name	Description
B1	n. u.	(not used)	A1	PRSNT1#	Hot-Plug presence detect
B2	n. u.	(not used)	A2	n. u.	(not used)
B3	n. u.	(not used)	A3	n. u.	(not used)
B4	GND	Ground	A4	GND	Ground
B5	n. u.	(not used)	A5	JTAG-TCK	JTAG Test Clock
B6	n. u.	(not used)	A6	JTAG-TDI	JTAG Test Data Input
B7	GND	Ground	A7	JTAG-TDO	JTAG Test Data Output
B8	3V3	3.3V Power	A8	JTAG-TMS	JTAG Test Mode Select Input
B9	JTAG-TRST#	JTAG Test Reset	A9	3V3	3.3V Power
B10	n. v.	(not used)	A10	3V3	3.3V Power
B11	n. u.	(not used)	A11	PERST#	PCIe Reset
Key					
B12	n. u.	(not used)	A12	GND	Ground
B13	GND	Ground	A13	PCIe_CLK+	PCIe Clock differential pair
B14	PCIe_TP	Transmitter Lane, differential pair	A14	PCIe_CLK-	
B15	PCIe_TN		A15	GND	Ground
B16	GND	Ground	A16	PCIe_RP	Receiver Lane, differential pair
B17	PRSNT2#	Hot-Plug presence detect	A17	PCIe_RN	
B18	GND	Ground	A18	GND	Ground
B19	n. u.	(not used)	A19	n. u.	(not used)
B20	n. u.	(not used)	A20	n. u.	(not used)
B21	n. u.	(not used)	A21	n. u.	(not used)
B22	n. u.	(not used)	A22	n. u.	(not used)
B23	GND	Ground	A23	n. u.	(not used)
B24	IO_SYNC0 / IO_SYNC1 / 3.3V <sup>3</sup>	Real-Time Ethernet SYNC <sup>4</sup>	A24	n. u.	(not used)
B25	GND	Ground	A25	n. u.	(not used)
B26	SPI_CS#	ID Chip Select	A26	n. u.	(not used)
B27	SPI_MOSI	ID Slave In	A27	n. u.	(not used)
B28	SPI_MISO	ID Slave Out	A28	n. u.	(not used)
B29	SPI_CLK	ID Clock	A29	n. u.	(not used)
B30	GND	Ground	A30	n. u.	(not used)
B31	n. u.	(not used)	A31	n. u.	(not used)
B32	n. u.	(not used)	A32	n. u.	(not used)

Table 106: Pin Assignment for PCI Express-Bus CIFX 100EH-RE\CUBE

<sup>2</sup>Pinning A19 to A32 / B19 to B32 not standard conform [bus spec 3, page 73-74].

<sup>3</sup>If at the SYNC connector J1 the jumper is set, the IO\_SYNC signal is transferred to the PCI Express Bus X2 pin B24 (jumper on pin1-pin2(J1): **IO\_SYNC0**, pin2-pin3(J1): **IO\_SYNC1**). If no jumper is set, the signal is **3,3V** static High (with Pull-up). Refer to section *Pin Assignment SYNC Connector, J1 (CIFX 100EH)*, on page 111.

<sup>4</sup>in 3V3 logic.

# 10 Technical Data

## 10.1 Technical Data PC Cards cifX



**Note:** All technical data are temporarily and can be altered without notice.

### 10.1.1 CIFX 50-RE

CIFX 50-RE	Parameter	Value
Part	Name	CIFX 50-RE
	Part No.	1250.100
	Description	PC Card cifX PCI Real-Time Ethernet Master or Slave
	Function	Communication interface with PCI and Ethernet interface
Communication Controller	Type	netX 500 processor
Integrated Memory	RAM	8 MB SDRAM
	FLASH	4 MB serial Flash EPROM
	Size of the Dual-Port Memory	64 KByte
System Interface	Bus Type	PCI, according to [bus spec 1], refer to section <i>Overview</i> , page 145.
	Transmission Rate	33 MHz
	Data Access	DPM or DMA (Direct Memory Access)
	Width for the data access to the Dual-Port Memory (DPM)	32-Bit
Ethernet Communication	Supported Real-Time Ethernet communication systems (determined by the loaded firmware)	CC-Link IE Field Basic Slave
		EtherCAT Master, EtherCAT Slave
		EtherNet/IP Scanner (Master), EtherNet/IP Adapter (Slave),
		Open Modbus/TCP
		POWERLINK Controlled Node/Slave
		PROFINET IO-Controller (Master), PROFINET IO-Device (Slave)
		Sercos Master, Sercos Slave
	VARAN Client (Slave)	
Ethernet Frame Types	Ethernet II	
Ethernet Interface	Transmission rate	100 MBit/s, 10 MBit/s (depending on loaded firmware)
	Interface Type	100 BASE-TX, 10 BASE-T (depending on loaded firmware), refer to section <i>Ethernet Interface</i> , page 135.
	Galvanic Isolation	isolated
	Isolation Voltage	1000 VDC (tested for 1 minute)
	Half duplex/Full duplex	depending on loaded firmware, supported (at 100 MBit/s)
	Auto-Negotiation	depending on loaded firmware
	Auto-Crossover	depending on loaded firmware
	Connector	2* RJ45 Socket
	Channel 0 and 1	With loaded EtherCAT Master firmware only the RJ45 channel 0 can be used, channel 1 is deactivated. Beginning with the EtherCAT Master firmware version 3 channel 1 can be reactivated if redundancy is activated. For Open Modbus/TCP with V2.3.4.0 and higher both

CIFX 50-RE	Parameter	Value	
		RJ45 channels can be used.	
Display	LED Display	<p><b>SYS</b> System Status LED</p> <p>The meaning of the following LEDs depends on the loaded firmware:</p> <p><b>COM 0</b> LED Communication Status 0 (duo LED)</p> <p><b>COM 1</b> LED Communication Status 1 (duo LED)</p> <p><b>LED yellow</b> at RJ45Ch0 and RJ45Ch1, for Ethernet Link status, Ethernet Activity status and additional status</p> <p><b>LED green</b></p> <p>Refer to chapter <i>LED Descriptions</i>, page 102.</p>	
Power supply	Supply Voltage	+3.3 V dc $\pm 5\%$ , refer to section <i>Power Supply and Host Interface</i> , page 44.	
	Current consumption at 3.3 V	650 mA (maximum)	
	Connector	Via PCI Bus	
Operation	Rotary Switch Slot Number (Card ID)	To set the Slot Number (Card ID)	
Environmental Conditions		CIFX 50-RE (to Rev. 5)	CIFX 50-RE (Rev. 6)
	Operating temperature range*	0 °C ... +55 °C	0 °C ... +70 °C
	*Air flow during measurement	0,5m/s	
	Storage temperature range	-40 °C ... +85 °C	
	Humidity	10 ... 95% relative humidity, no condensation permitted	
	Environment	For UL compliant usage: The device must be used in a pollution degree 2 environment.	
Device	Dimensions (L x W x H)	120,0 x 86 x 18,5 mm (from hardware revision 3)	
	Mounting/Installation	PCI slot (3.3 V), refer to section <i>Slot for the PC Cards cifX PCI, PCIe and Low Profile PCIe</i> , page 43.	
	RoHS	Yes	
CE Sign	CE Sign	Yes	
	Emission	EN 55011:2009 + A1:2010, CISPR 11:2009, Class A (Radio disturbance characteristics - Limits and methods of measurement)	
	Immunity	EN 61000-4-2:2009 (Electrostatic discharge test) EN 61000-4-3:2006 + A1:2008 + A2:2010 (Radiated, radio-frequency, electromagnetic field test) EN 61000-4-4:2004 + A1:2010 (Burst Electrical fast transients/burst test) EN 61000-4-5:2006 (Surge test) EN 61000-4-6:2009 (to conducted disturbances, induced by radio- frequency fields) EN 61000-4-8:2010 (power frequency magnetic field test) EN 61000-6-2:2005 + B1:2011 (for industrial environments)	
UL Certification	The device CIFX 50-RE is certified according to UL 508.	UL-File-Nr. E221530	
Configuration	Configuration Software Master and Slave	SYCON.net	
	Configuration Software Slave	netX Configuration Tool	

Table 107: Technical Data CIFX 50-RE

### 10.1.2 CIFX 50E-RE, CIFX 50E-RE\ET

CIFX 50E-RE, CIFX 50E-RE\ET	Parameter	Value	
Part	Name	CIFX 50E-RE	CIFX 50E-RE\ET
	Part No.	1251.100	1251.105
	Description	PC Card cifX PCI Express Real-Time Ethernet Master or Slave	
	Function	Communication interface with PCI Express and Ethernet interface	
Communication Controller	Type	netX 500 processor	
Integrated Memory	RAM	8 MB SDRAM	
	FLASH	4 MB serial Flash EPROM	
	Size of the Dual-Port Memory	64 KByte	
System Interface	Bus Type	PCI Express, One Lane Port, according to [bus spec 2, Rev. 2.0] and [bus spec 3], refer to section <i>Overview</i> , page 145.	
	Transmission Rate	2 GBit/s	
	Data Access	DPM or DMA* (Direct Memory Access); *beginning from Hardware Revision 4	
	Width for the data access to the Dual-Port Memory (DPM)	32-Bit	
Ethernet Communication	Supported Real-Time Ethernet communication systems (determined by the loaded firmware)	CC-Link IE Field Basic Slave	
		EtherCAT Master, EtherCAT Slave	
		EtherNet/IP Scanner (Master), EtherNet/IP Adapter (Slave),	
		Open Modbus/TCP	
		POWERLINK Controlled Node/Slave	
		PROFINET IO-Controller (Master), PROFINET IO-Device (Slave)	
		Sercos Master, Sercos Slave	
	VARAN Client (Slave)		
Ethernet Frame Types	Ethernet II		
Ethernet Interface	Transmission rate	100 MBit/s, 10 MBit/s (depending on loaded firmware)	
	Interface Type	100 BASE-TX, 10 BASE-T (depending on loaded firmware), refer to section <i>Ethernet Interface</i> , page 135.	
	Galvanic Isolation	isolated	
	Isolation Voltage	1000 VDC (tested for 1 minute)	
	Half duplex/Full duplex	depending on loaded firmware, supported (at 100 MBit/s)	
	Auto-Negotiation	depending on loaded firmware	
	Auto-Crossover	depending on loaded firmware	
	Connector	2* RJ45 Socket	
Channel 0 and 1	With loaded EtherCAT Master firmware only the RJ45 channel 0 can be used, channel 1 is deactivated. Beginning with the EtherCAT Master firmware version 3 channel 1 can be reactivated if redundancy is activated. For Open Modbus/TCP with V2.3.4.0 and higher both RJ45 channels can be used.		

CIFX 50E-RE, CIFX 50E-RE\ET	Parameter	Value	
Display	LED Display	<p><b>SYS</b> System Status LED</p> <p>The meaning of the following LEDs depends on the loaded firmware:</p> <p><b>COM 0</b> LED Communication Status 0 (duo LED)</p> <p><b>COM 1</b> LED Communication Status 1 (duo LED)</p> <p><b>LED yellow</b> at RJ45Ch0 and RJ45Ch1, for Ethernet Link status, Ethernet Activity status and additional status</p> <p><b>LED green</b></p> <p>Refer to chapter <i>LED Descriptions</i>, page 102.</p>	
Power supply	Supply Voltage	+3.3 V dc $\pm$ 5 %, refer to section <i>Power Supply and Host Interface</i> , page 44.	
	Current consumption at 3.3 V	800 mA (maximum)	
	Connector	Via PCI Express Bus	
Operation	Rotary Switch Slot Number (Card ID)	To set the Slot Number (Card ID)	
Environmental Conditions		CIFX 50E-RE	CIFX 50E-RE\ET
	Operating temperature range*	0 °C ... +55 °C	0 °C ... +70 °C
	*Air flow during measurement	0,5m/s	
	Storage temperature range	-40 °C ... +85 °C	
	Humidity	10 ... 95% relative humidity, no condensation permitted	
	Environment	For UL compliant usage: The device must be used in a pollution degree 2 environment.	
Device	Dimensions (L x W x H)	120,0 x 86 x 18,5 mm (from hardware revision 4)	
	Mounting/Installation	PCI Express x1 slot (3.3 V), refer to section <i>Slot for the PC Cards cifX PCI, PCIe and Low Profile PCIe</i> , page 43.	
	RoHS	Yes	
CE Sign	CE Sign	Yes	
	Emission	EN 55011:2009 + A1:2010, CISPR 11:2009, Class A (Radio disturbance characteristics - Limits and methods of measurement)	
	Immunity	EN 61000-4-2:2009 (Electrostatic discharge test) EN 61000-4-3:2006 + A1:2008 + A2:2010 (Radiated, radio-frequency, electromagnetic field test) EN 61000-4-4:2004 + A1:2010 (Burst Electrical fast transients/burst test) EN 61000-4-5:2006 (Surge test) EN 61000-4-6:2009 (to conducted disturbances, induced by radio- frequency fields) EN 61000-4-8:2010 (power frequency magnetic field test) EN 61000-6-2:2005 + B1:2011 (for industrial environments)	
UL Certification	The device CIFX 50E-RE is certified according to UL 508.	UL-File-Nr. E221530	
Configuration	Configuration Software Master and Slave	SYCON.net	
	Configuration Software Slave	netX Configuration Tool	

Table 108: Technical Data CIFX 50E-RE, CIFX 50E-RE\ET

### 10.1.3 CIFX 50E-CCIES, CIFX 70E-CCIES

CIFX 50E-CCIES, CIFX 70E-CCIES	Parameter	Value	
Part	Name	CIFX 50E-CCIES	CIFX 70E-CCIES
	Part No.	1251.700	1259.700
	Description	PC Card cifX PCI Express CC-Link IE Field Slave	
	Function	Communication interface with PCI Express and Ethernet interface	
Communication Controllers	Type	netX 100 processor CP520 (CC-Link IE Communication Controller)	
Integrated Memory	RAM	SDRAM 64MBIT	
	FLASH	4 MB or 32 MBIT serial Flash EPROM	
	Size of the Dual-Port Memory	64 KByte	
System Interface	Bus Type	PCI Express, One Lane Port, according to [bus spec 2, Rev. 2.0] and [bus spec 3], refer to section <i>Overview</i> , page 145.	
	Transmission Rate	2 GBit/s	
	Data Access	DPM or DMA (Direct Memory Access)	
	Width for the data access to the Dual-Port Memory (DPM)	32-Bit	
Ethernet Communication	Supported Real-Time Ethernet communication system	CC-Link IE Field Slave	
	Ethernet Frame Types	Ethernet II	
Ethernet Interface	Transmission rate	1 Gbit/s	
	Interface Type	1000 BASE-T, refer to section <i>Ethernet Interface</i> , p. 135.	
	Galvanic Isolation	isolated	
	Isolation Voltage	1000 VDC (getestet für 1 Minute)	
	Auto-Negotiation	Constantly on	
	Auto-Crossover	Constantly on	
	Connector	2* RJ45 Socket	
	Channel 0 and 1	Always 2 channels can be used.	
Display	LED Display For Details refer to section <i>CC-Link IE Field Slave</i> , page 106.	<b>SYS</b>	System Status LED
		<b>RUN</b>	Run
		<b>RD</b>	Reception status o the data
		<b>SD</b>	Sending status o the data
		<b>D-LINK</b>	Data link
		<b>ERR</b>	Error
		<b>USER</b>	User-defined status
		At RJ45Ch0 and RJ45Ch1:	
		<b>LINK</b> (LED yellow)	Link status (for Ethernet)
		<b>L-ERR</b> (LED green)	Error status of the received data, the line and the loopback (for Ethernet)
Power supply	Supply Voltage	+3.3 V dc $\pm 5\%$ , refer to section <i>Power Supply and Host Interface</i> , page 44.	
	Current consumption at 3.3 V	880 mA (typical)	
		1200 mA (maximum)	
Connector	Via PCI Express Bus		
Operation	Rotary Switch Slot Number (Card ID)	To set the Slot Number (Card ID)	

CIFX 50E-CCIES, CIFX 70E-CCIES	Parameter	Value	
Environmental Conditions	Operating temperature range*	CIFX 50E-CCIES	CIFX 70E-CCIES
		-25 °C ... +70 °C	-25 °C ... +70 °C
	*Air flow during measurment	0,5m/s	
	Storage temperature range	-40 °C ... +85 °C	
	Humidity	10 ... 95% relative humidity, no condensation permitted	
Device	Dimensions (L x W x H)	120,0 x 69,0 x 18,5 mm (length incl. front plate)	
	Mounting/Installation	PCI Express x1 slot (3.3 V), refer to section <i>Slot for the PC Cards cifX PCI, PCIe and Low Profile PCIe</i> , page 43.	
	RoHS	Yes	
CE Sign	CE Sign	Yes	
	Emission	Refer to CE declaration of conformity	
	Immunity	Refer to CE declaration of conformity	
Configuration	Configuration Software	SYCON.net	

Table 109: Technical Data CIFX 50E-CCIES, CIFX 70E-CCIES



### 10.1.4 CIFX 50-DP

CIFX 50-DP	Parameter	Value
Part	Name	CIFX 50-DP
	Part No.	1250.410
	Description	PC Card cifX PCI PROFIBUS DP Master or Slave and PROFIBUS MPI Device
	Function	Communication interface with PCI and PROFIBUS interface
Communication Controller	Type	netX 100 processor
Integrated Memory	RAM	8 MB SDRAM
	FLASH	4 MB serial Flash EPROM
	Size of the Dual-Port Memory	64 KByte
System Interface	Bus Type	PCI, according to [bus spec 1], refer to section <i>Overview</i> , page 145.
	Transmission Rate	33 MHz
	Data Access	DPM or DMA (Direct Memory Access)
	Width for the data access to the Dual-Port Memory (DPM)	32-Bit
PROFIBUS Communication	Supported communication standard/ protocol (determined by the loaded firmware)	PROFIBUS DP Master, PROFIBUS DP Slave, PROFIBUS MPI Device
PROFIBUS Interface	Transmission rate	9,6 kBit/s, 19,2 kBit/s, 31,25 kBit/s, 45,45 kBit/s, 93,75 kBit/s, 187,5 kBit/s, 500 kBit/s, 1,5 MBit/s, 3 MBit/s, 6 MBit/s, 12 MBit/s
	Interface Type	RS 485, according EN 50170, refer to section <i>PROFIBUS Interface</i> page 138.
	Galvanic Isolation	isolated
	Isolation Voltage	1000 VDC (tested for 1 minute)
	Connector	DSub female Connector, 9 pin
Display	LED Display	<p><b>SYS</b> System Status LED</p> <p><b>COM</b> LED Communication Status (duo LED)</p> <p>The meaning of the COM LED depends on the loaded firmware. Refer to chapter <i>LED Descriptions</i>, page 102.</p>
Power supply	Supply Voltage	+3.3 V dc $\pm 5\%$ , refer to section <i>Power Supply and Host Interface</i> , page 44.
	Current consumption at 3.3 V	700 mA (maximum)
	Connector	Via PCI Bus
Operation	Rotary Switch Slot Number (Card ID)	To set the Slot Number (Card ID)
Environmental Conditions	Operating temperature range*	-20 °C ... +70 °C (acc. to UL: 0 °C ... +55 °C)
	*Air flow during measurement	0,5m/s
	Storage temperature range	-40 °C ... +85 °C
	Humidity	10 ... 95% relative humidity, no condensation permitted
	Environment	For UL compliant usage: The device must be used in a pollution degree 2 environment.
Device	Dimensions (L x W x H)	120,0 x 86 x 18,5 mm (from hardware revision 5)
	Mounting/Installation	PCI slot (3.3 V), refer to section <i>Slot for the PC Cards cifX PCI, PCIe and Low Profile PCIe</i> , page 43.
	RoHS	Yes

CIFX 50-DP	Parameter	Value
CE Sign	CE Sign	Yes
	Emission	EN 55011:2009 + A1:2010, CISPR 11:2009, Class A (Radio disturbance characteristics - Limits and methods of measurement)
	Immunity	EN 61000-4-2:2009 (Electrostatic discharge test) EN 61000-4-3:2006 + A1:2008 + A2:2010 (Radiated, radio-frequency, electromagnetic field test) EN 61000-4-4:2004 + A1:2010 (Burst Electrical fast transients/burst test) EN 61000-4-5:2006 (Surge test) EN 61000-4-6:2009 (to conducted disturbances, induced by radio- frequency fields) EN 61000-4-8:2010 (power frequency magnetic field test) EN 61000-6-2:2005 + B1:2011 (for industrial environments)
UL Certification	The device CIFX 50-DP is certified according to UL 508.	UL-File-Nr. E221530
Configuration	Configuration Software Master and Slave	SYCON.net
	Configuration Software Slave	netX Configuration Tool

Table 110: Technical Data CIFX 50-DP

### 10.1.5 CIFX 50E-DP

CIFX 50E-DP	Parameter	Value
Part	Name	CIFX 50E-DP
	Part No.	1251.410
	Description	PC Card cifX PCI Express PROFIBUS DP Master or Slave and PROFIBUS MPI Device
	Function	Communication interface with PCI Express and PROFIBUS interface
Communication Controller	Type	netX 100 processor
Integrated Memory	RAM	8 MB SDRAM
	FLASH	4 MB serial Flash EPROM
	Size of the Dual-Port Memory	64 KByte
System Interface	Bus Type	PCI Express, One Lane Port, according to [bus spec 2, Rev. 2.0] and [bus spec 3], refer to section <i>Overview</i> , page 145.
	Transmission Rate	2 GBit/s
	Data Access	DPM or DMA* (Direct Memory Access); *beginning from Hardware Revision 5
	Width for the data access to the Dual-Port Memory (DPM)	32-Bit
PROFIBUS Communication	Supported communication standard/ protocol (determined by the loaded firmware)	PROFIBUS DP Master, PROFIBUS DP Slave, PROFIBUS MPI Device
PROFIBUS Interface	Transmission rate	9,6 kBit/s, 19,2 kBit/s, 31,25 kBit/s, 45,45 kBit/s, 93,75 kBit/s, 187,5 kBit/s, 500 kBit/s, 1,5 MBit/s, 3 MBit/s, 6 MBit/s, 12 MBit/s
	Interface Type	RS 485, refer to section <i>PROFIBUS Interface</i> page 138.
	Galvanic Isolation	isolated
	Isolation Voltage	1000 VDC (tested for 1 minute)

CIFX 50E-DP	Parameter	Value
	Connector	DSub female Connector, 9 pin
Display	LED Display	<b>SYS</b> System Status LED <b>COM</b> LED Communication Status (duo LED) The meaning of the COM LED depends on the loaded firmware. Refer to chapter <i>LED Descriptions</i> , page 102.
Power supply	Supply Voltage	+3.3 V dc $\pm 5\%$ , refer to section <i>Power Supply and Host Interface</i> , page 44.
	Current consumption at 3.3 V	800 mA (maximum)
	Connector	Via PCI Express Bus
Operation	Rotary Switch Slot Number (Card ID)	To set the Slot Number (Card ID)
Environmental Conditions	Operating temperature range*	-20 °C ... +70 °C (acc. to UL: 0 °C ... +55 °C)
	*Air flow during measurement	0,5m/s
	Storage temperature range	-40 °C ... +85 °C
	Humidity	10 ... 95% relative humidity, no condensation permitted
	Environment	For UL compliant usage: The device must be used in a pollution degree 2 environment.
Device	Dimensions (L x W x H)	120,0 x 86 x 18,5 mm (from hardware revision 5)
	Mounting/Installation	PCI Express x1 slot (3.3 V), refer to section <i>Slot for the PC Cards cifX PCI, PCIe and Low Profile PCIe</i> , page 43.
	RoHS	Yes
CE Sign	CE Sign	Yes
	Emission	EN 55011:2009 + A1:2010, CISPR 11:2009, Class A (Radio disturbance characteristics - Limits and methods of measurement)
	Immunity	EN 61000-4-2:2009 (Electrostatic discharge test) EN 61000-4-3:2006 + A1:2008 + A2:2010 (Radiated, radio-frequency, electromagnetic field test) EN 61000-4-4:2004 + A1:2010 (Burst Electrical fast transients/burst test) EN 61000-4-5:2006 (Surge test) EN 61000-4-6:2009 (to conducted disturbances, induced by radio- frequency fields) EN 61000-4-8:2010 (power frequency magnetic field test) EN 61000-6-2:2005 + B1:2011 (for industrial environments)
UL Certification	The device CIFX 50E-DP is certified according to UL 508.	UL-File-Nr. E221530
Configuration	Configuration Software Master and Slave	SYCON.net
	Configuration Software Slave	netX Configuration Tool

Table 111: Technical Data CIFX 50E-DP

### 10.1.6 CIFX 50-CO

CIFX 50-CO	Parameter	Value
Part	Name	CIFX 50-CO
	Part No.	1250.500
	Description	PC Card cifX PCI CANopen Master or Slave
	Function	Communication interface with PCI and CANopen interface
Communication Controller	Type	netX 100 processor
Integrated Memory	RAM	8 MB SDRAM
	FLASH	4 MB serial Flash EPROM
	Size of the Dual-Port Memory	64 KByte
System Interface	Bus Type	PCI, according to [bus spec 1], refer to section <i>Overview</i> , page 145.
	Transmission Rate	33 MHz
	Data Access	DPM or DMA (Direct Memory Access)
	Width for the data access to the Dual-Port Memory (DPM)	32-Bit
CANopen Communication	Supported communication standard/ protocol (determined by the loaded firmware)	CANopen Master, CANopen Slave
CANopen Interface	Transmission rate	10 kBit/s, 20 kBit/s, 50 kBit/s, 100 kBit/s, 125 kBit/s, 250 kBit/s, 500 kBit/s, 800 kBit/s, 1 MBit/s
	Interface Type	ISO-11898, refer to section <i>CANopen Interface</i> , page 138.
	Galvanic Isolation	optically isolated
	Isolation Voltage	1000 VDC (tested for 1 minute)
	Connector	DSub male Connector, 9 pin
Display	LED Display	<p><b>SYS</b> System Status LED</p> <p><b>CAN</b> CANopen Status (duo LED)</p> <p>The meaning of the CAN LED depends on the loaded firmware. Refer to chapter <i>LED Descriptions</i>, page 102.</p>
Power supply	Supply Voltage	+3.3 V dc $\pm 5\%$ , refer to section <i>Power Supply and Host Interface</i> , page 44.
	Current consumption at 3.3 V	650 mA (maximum)
	Connector	Via PCI Bus
Operation	Rotary Switch Slot Number (Card ID)	To set the Slot Number (Card ID)
Environmental Conditions	Operating temperature range*	-20 °C ... +70 °C (acc. to UL: 0 °C ... +55 °C)
	*Air flow during measurement	0,5m/s
	Storage temperature range	-40 °C ... +85 °C
	Humidity	10 ... 95% relative humidity, no condensation permitted
	Environment	For UL compliant usage: The device must be used in a pollution degree 2 environment.
Device	Dimensions (L x W x H)	120,0 x 86 x 18,5 mm (from hardware revision 5)
	Mounting/Installation	PCI slot (3.3 V), refer to section <i>Slot for the PC Cards cifX PCI, PCIe and Low Profile PCIe</i> , page 43.
	RoHS	Yes
CE Sign	CE Sign	Yes
	Emission	EN 55011:2009 + A1:2010, CISPR 11:2009, Class A (Radio disturbance characteristics - Limits and methods of measurement)

CIFX 50-CO	Parameter	Value
	Immunity	EN 61000-4-2:2009 (Electrostatic discharge test) EN 61000-4-3:2006 + A1:2008 + A2:2010 (Radiated, radio-frequency, electromagnetic field test) EN 61000-4-4:2004 + A1:2010 (Burst Electrical fast transients/burst test) EN 61000-4-5:2006 (Surge test) EN 61000-4-6:2009 (to conducted disturbances, induced by radio- frequency fields) EN 61000-4-8:2010 (power frequency magnetic field test) EN 61000-6-2:2005 + B1:2011 (for industrial environments)
UL Certification	The device CIFX 50-CO is certified according to UL 508.	UL-File-Nr. E221530
Configuration	Configuration Software Master and Slave	SYCON.net
	Configuration Software Slave	netX Configuration Tool

Table 112: Technical Data CIFX 50-CO

### 10.1.7 CIFX 50E-CO

CIFX 50E-CO	Parameter	Value
Part	Name	CIFX 50E-CO
	Part No.	1251.500
	Description	PC Card cifX PCI ExpressCANopen Master or Slave
	Function	Communication interface with PCI Express and CANopen interface
Communication Controller	Type	netX 100 processor
Integrated Memory	RAM	8 MB SDRAM
	FLASH	4 MB serial Flash EPROM
	Size of the Dual-Port Memory	64 KByte
System Interface	Bus Type	PCI Express, One Lane Port, according to [bus spec 2, Rev. 2.0] and [bus spec 3], refer to section <i>Overview</i> , page 145.
	Transmission Rate	2 GBit/s
	Data Access	DPM or DMA* (Direct Memory Access); *beginning from Hardware Revision 4
	Width for the data access to the Dual-Port Memory (DPM)	32-Bit
CANopen Communication	Supported communication standard/ protocol (determined by the loaded firmware)	CANopen Master, CANopen Slave
CANopen Interface	Transmission rate	10 kBit/s, 20 kBit/s, 50 kBit/s, 100 kBit/s, 125 kBit/s, 250 kBit/s, 500 kBit/s, 800 kBit/s, 1 MBit/s
	Interface Type	ISO-11898, refer to section <i>CANopen Interface</i> , page 138.
	Galvanic Isolation	optically isolated
	Isolation Voltage	1000 VDC (tested for 1 minute)
	Connector	DSub male Connector, 9 pin
Display	LED Display	<b>SYS</b> System Status LED <b>CAN</b> CANopen Status (duo LED) The meaning of the CAN LED depends on the loaded

CIFX 50E-CO	Parameter	Value
		firmware. Refer to chapter <i>LED Descriptions</i> , page 102.
Power supply	Supply Voltage	+3.3 V dc $\pm 5\%$ , refer to section <i>Power Supply and Host Interface</i> , page 44.
	Current consumption at 3.3 V	800 mA (maximum)
	Connector	Via PCI Express Bus
Operation	Rotary Switch Slot Number (Card ID)	To set the Slot Number (Card ID)
Environmental Conditions	Operating temperature range*	-20 °C ... +70 °C (acc. to UL: 0 °C ... +55 °C)
	*Air flow during measurement	0,5m/s
	Storage temperature range	-40 °C ... +85 °C
	Humidity	10 ... 95% relative humidity, no condensation permitted
	Environment	For UL compliant usage: The device must be used in a pollution degree 2 environment.
Device	Dimensions (L x W x H)	120,0 x 86 x 18,5 mm (from hardware revision 4)
	Mounting/Installation	PCI Express x1 slot (3.3 V), refer to section <i>Slot for the PC Cards cifX PCI, PCIe and Low Profile PCIe</i> , page 43.
	RoHS	Yes
CE Sign	CE Sign	Yes
	Emission	EN 55011:2009 + A1:2010, CISPR 11:2009, Class A (Radio disturbance characteristics - Limits and methods of measurement)
	Immunity	EN 61000-4-2:2009 (Electrostatic discharge test) EN 61000-4-3:2006 + A1:2008 + A2:2010 (Radiated, radio-frequency, electromagnetic field test) EN 61000-4-4:2004 + A1:2010 (Burst Electrical fast transients/burst test) EN 61000-4-5:2006 (Surge test) EN 61000-4-6:2009 (to conducted disturbances, induced by radio- frequency fields) EN 61000-4-8:2010 (power frequency magnetic field test) EN 61000-6-2:2005 + B1:2011 (for industrial environments)
UL Certification	The device CIFX 50E-CO is certified according to UL 508.	UL-File-Nr. E221530
Configuration	Configuration Software Master and Slave	SYCON.net
	Configuration Software Slave	netX Configuration Tool

Table 113: Technical Data CIFX 50E-CO

### 10.1.8 CIFX 50-DN

CIFX 50-DN	Parameter	Value
Part	Name	CIFX 50-DN
	Part No.	1250.510
	Description	PC Card cifX PCI DeviceNet Master or Slave
	Function	Communication interface with PCI and DeviceNet interface
Communication Controller	Type	netX 100 processor
Integrated Memory	RAM	8 MB SDRAM
	FLASH	4 MB serial Flash EPROM

CIFX 50-DN	Parameter	Value
	Size of the Dual-Port Memory	64 KByte
System Interface	Bus Type	PCI, according to [bus spec 1], refer to section <i>Overview</i> , page 145.
	Transmission Rate	33 MHz
	Data Access	DPM or DMA (Direct Memory Access)
	Width for the data access to the Dual-Port Memory (DPM)	32-Bit
DeviceNet Communication	Supported communication standard/ protocol (determined by the loaded firmware)	DeviceNet Master, DeviceNet Slave
DeviceNet Interface	Transmission rate	125 kBit/s, 250 kBit/s, 500 kBit/s
	Interface Type	ISO-11898 according to DeviceNet specification, refer to section <i>DeviceNet Interface</i> , page 139.
	Galvanic Isolation	optically isolated
	Isolation Voltage	1000 VDC (tested for 1 minute)
	Connector	CombiCon male Connector, 5 pin
Display	LED Display	<p><b>SYS</b> System Status LED</p> <p><b>MNS</b> Module Network Status (duo LED)</p> <p>The meaning of the MNS LED depends on the loaded firmware. Refer to chapter <i>LED Descriptions</i>, page 102.</p>
Power supply	Supply Voltage	+3.3 V dc $\pm 5\%$ , refer to section <i>Power Supply and Host Interface</i> , page 44.
	Current consumption at 3.3 V	650 mA (maximum)
	Connector	Via PCI Bus
Operation	Rotary Switch Slot Number (Card ID)	To set the Slot Number (Card ID)
Environmental Conditions	Operating temperature range*	-20 °C ... +70 °C (acc. to UL: 0 °C ... +55 °C)
	*Air flow during measurement	0,5m/s
	Storage temperature range	-40 °C ... +85 °C
	Humidity	10 ... 95% relative humidity, no condensation permitted
	Environment	For UL compliant usage: The device must be used in a pollution degree 2 environment.
Device	Dimensions (L x W x H)	120,0 x 86 x 18,5 mm (from hardware revision 5)
	Mounting/Installation	PCI slot (3.3 V), refer to section <i>Slot for the PC Cards cifX PCI, PCIe and Low Profile PCIe</i> , page 43.
	RoHS	Yes
CE Sign	CE Sign	Yes
	Emission	EN 55011:2009 + A1:2010, CISPR 11:2009, Class A (Radio disturbance characteristics - Limits and methods of measurement)
	Immunity	<p>EN 61000-4-2:2009 (Electrostatic discharge test)</p> <p>EN 61000-4-3:2006 + A1:2008 + A2:2010 (Radiated, radio-frequency, electromagnetic field test)</p> <p>EN 61000-4-4:2004 + A1:2010 (Burst Electrical fast transients/burst test)</p> <p>EN 61000-4-5:2006 (Surge test)</p> <p>EN 61000-4-6:2009 (to conducted disturbances, induced by radio- frequency fields)</p> <p>EN 61000-4-8:2010 (power frequency magnetic field test)</p> <p>EN 61000-6-2:2005 + B1:2011 (for industrial</p>

CIFX 50-DN	Parameter	Value
		environments)
UL Certification	The device CIFX 50-DN is certified according to UL 508.	UL-File-Nr. E221530
Configuration	Configuration Software Master and Slave	SYCON.net
	Configuration Software Slave	netX Configuration Tool

Table 114: Technical Data CIFX 50-DN

### 10.1.9 CIFX 50E-DN

CIFX 50E-DN	Parameter	Value
Part	Name	CIFX 50E-DN
	Part No.	1251.510
	Description	PC Card cifX PCI ExpressDeviceNet Master or Slave
	Function	Communication interface with PCI Express and DeviceNet interface
Communication Controller	Type	netX 100 processor
Integrated Memory	RAM	8 MB SDRAM
	FLASH	4 MB serial Flash EPROM
	Size of the Dual-Port Memory	64 KByte
System Interface	Bus Type	PCI Express, One Lane Port, according to [bus spec 2, Rev. 2.0] and [bus spec 3], refer to section <i>Overview</i> , page 145.
	Transmission Rate	2 GBit/s
	Data Access	DPM or DMA* (Direct Memory Access); *beginning from Hardware Revision 4
	Width for the data access to the Dual-Port Memory (DPM)	32-Bit
DeviceNet Communication	Supported communication standard/ protocol (determined by the loaded firmware)	DeviceNet Master, DeviceNet Slave
DeviceNet Interface	Transmission rate	125 kBit/s, 250 kBit/s, 500 kBit/s
	Interface Type	ISO-11898 according to DeviceNet specification, refer to section <i>DeviceNet Interface</i> , page 139.
	Galvanic Isolation	optically isolated
	Isolation Voltage	1000 VDC (tested for 1 minute)
	Connector	CombiCon male Connector, 5 pin
Display	LED Display	<b>SYS</b> System Status LED <b>MNS</b> Module Network Status (duo LED) The meaning of the MNS LED depends on the loaded firmware. Refer to chapter <i>LED Descriptions</i> , page 102..
Power supply	Supply Voltage	+3.3 V dc ±5 %, refer to section <i>Power Supply and Host Interface</i> , page 44.
	Current consumption at 3.3 V	800 mA (maximum)
	Connector	Via PCI Express Bus
Operation	Rotary Switch Slot Number (Card ID)	To set the Slot Number (Card ID)
Environmental Conditions	Operating temperature range*	-20 °C ... +70 °C (acc. to UL: 0 °C ... +55 °C)
	*Air flow during measurment	0,5m/s
	Storage temperature range	-40 °C ... +85 °C



CIFX 50E-DN	Parameter	Value
	Humidity	10 ... 95% relative humidity, no condensation permitted
	Environment	For UL compliant usage: The device must be used in a pollution degree 2 environment.
Device	Dimensions (L x W x H)	120,0 x 86 x 18,5 mm (from hardware revision 4)
	Mounting/Installation	PCI Express x1 slot (3.3 V), refer to section <i>Slot for the PC Cards cifX PCI, PCIe and Low Profile PCIe</i> , page 43.
	RoHS	Yes
CE Sign	CE Sign	Yes
	Emission	EN 55011:2009 + A1:2010, CISPR 11:2009, Class A (Radio disturbance characteristics - Limits and methods of measurement)
	Immunity	EN 61000-4-2:2009 (Electrostatic discharge test) EN 61000-4-3:2006 + A1:2008 + A2:2010 (Radiated, radio-frequency, electromagnetic field test) EN 61000-4-4:2004 + A1:2010 (Burst Electrical fast transients/burst test) EN 61000-4-5:2006 (Surge test) EN 61000-4-6:2009 (to conducted disturbances, induced by radio- frequency fields) EN 61000-4-8:2010 (power frequency magnetic field test) EN 61000-6-2:2005 + B1:2011 (for industrial environments)
UL Certification	The device CIFX 50E-DN is certified according to UL 508.	UL-File-Nr. E221530
Configuration	Configuration Software Master and Slave	SYCON.net
	Configuration Software Slave	netX Configuration Tool

Table 115: Technical Data CIFX 50E-DN

### 10.1.10 CIFX 50-CC

CIFX 50-CC	Parameter	Value
Part	Name	CIFX 50-CC
	Part No.	1250.740
	Description	PC Card cifX PCI CC-Link Slave
	Function	Communication interface with PCI and CC-Link interface
Communication Controller	Type	netX 100 processor
Integrated Memory	RAM	8 MB SDRAM
	FLASH	4 MB serial Flash EPROM
	Size of the Dual-Port Memory	64 KByte
System Interface	Bus Type	PCI, according to [bus spec 1], refer to section <i>Overview</i> , page 145.
	Transmission Rate	33 MHz
	Data Access	DPM or DMA (Direct Memory Access)
	Width for the data access to the Dual-Port Memory (DPM)	32-Bit
CC-Link Communication	Supported communication standard/ protocol (determined by the loaded firmware)	CC-Link Slave
CC-Link Interface	Transmission rate	156 kBit/s, 625 kBit/s, 2500 kBit/s, 5 MBit/s, 10 MBit/s

CIFX 50-CC	Parameter	Value
	Interface Type	RS-485, refer to section <i>CC-Link Interface</i> , page 140.
	Galvanic Isolation	optically isolated
	Isolation Voltage	1000 VDC (tested for 1 minute)
	Connector	CombiCon male Connector, 5 pin
Display	LED Display	<b>SYS</b> System Status LED <b>L RUN</b> LED L Run (Duo LED) <b>L ERR</b> LED L Error (Duo LED) Refer to chapter <i>LED Descriptions</i> , page 102.
Power supply	Supply Voltage	+3.3 V dc $\pm 5\%$ , refer to section <i>Power Supply and Host Interface</i> , page 44.
	Current consumption at 3.3 V	650 mA (maximum)
	Connector	Via PCI Bus
Operation	Rotary Switch Slot Number (Card ID)	To set the Slot Number (Card ID)
Environmental Conditions	Operating temperature range*	-20 °C ... +55 °C
	*Air flow during measurement	0,5m/s
	Storage temperature range	-40 °C ... +85 °C
	Humidity	10 ... 95% relative humidity, no condensation permitted
	Environment	For UL compliant usage: The device must be used in a pollution degree 2 environment.
Device	Dimensions (L x W x H)	120 x 85,4 x 18,5 mm (from hardware revision 2)
	Mounting/Installation	PCI slot (3.3 V), refer to section <i>Slot for the PC Cards cifX PCI, PCIe and Low Profile PCIe</i> , page 43.
	RoHS	Yes
CE Sign	CE Sign	Yes
	Emission	EN 55011:2009 + A1:2010, CISPR 11:2009, Class A (Radio disturbance characteristics - Limits and methods of measurement)
	Immunity	EN 61000-4-2:2009 (Electrostatic discharge test) EN 61000-4-3:2006 + A1:2008 + A2:2010 (Radiated, radio-frequency, electromagnetic field test) EN 61000-4-4:2004 + A1:2010 (Burst Electrical fast transients/burst test) EN 61000-4-5:2006 (Surge test) EN 61000-4-6:2009 (to conducted disturbances, induced by radio- frequency fields) EN 61000-4-8:2010 (power frequency magnetic field test) EN 61000-6-2:2005 + B1:2011 (for industrial environments)
UL Certification	The device CIFX 50-CC is certified according to UL 508.	UL-File-Nr. E221530
Configuration	Configuration Software	SYCON.net or netX Configuration Tool

Table 116: Technical Data CIFX 50-CC

### 10.1.11 CIFX 50E-CC

CIFX 50E-CC	Parameter	Value
Part	Name	CIFX 50E-CC
	Part No.	1251.740

CIFX 50E-CC	Parameter	Value
	Description	PC Card cifX PCI ExpressCC-Link Slave
	Function	Communication interface with PCI Express and CC-Link interface
Communication Controller	Type	netX 100 processor
Integrated Memory	RAM	8 MB SDRAM
	FLASH	4 MB serial Flash EPROM
	Size of the Dual-Port Memory	64 KByte
System Interface	Bus Type	PCI Express, One Lane Port, according to [bus spec 2, Rev. 2.0] and [bus spec 3], refer to section <i>Overview</i> , page 145.
	Transmission Rate	2 GBit/s
	Data Access	DPM or DMA* (Direct Memory Access); *beginning from Hardware Revision 3
	Width for the data access to the Dual-Port Memory (DPM)	32-Bit
CC-Link Communication	Supported communication standard/ protocol (determined by the loaded firmware)	CC-Link Slave
CC-Link Interface	Transmission rate	156 kBit/s, 625 kBit/s, 2500 kBit/s, 5 MBit/s, 10 MBit/s
	Interface Type	RS-485, refer to section <i>CC-Link Interface</i> , page 140.
	Galvanic Isolation	optically isolated
	Isolation Voltage	1000 VDC (tested for 1 minute)
	Connector	CombiCon male Connector, 5 pin
Display	LED Display	<b>SYS</b> System Status LED <b>L RUN</b> LED L Run (Duo LED) <b>L ERR</b> LED L Error (Duo LED) Refer to chapter <i>LED Descriptions</i> , page 102.
Power supply	Supply Voltage	+3.3 V dc $\pm$ 5 %, refer to section <i>Power Supply and Host Interface</i> , page 44.
	Current consumption at 3.3 V	800 mA (maximum)
	Connector	Via PCI Express Bus
Operation	Rotary Switch Slot Number (Card ID)	To set the Slot Number (Card ID)
Environmental Conditions	Operating temperature range*	0 °C ... +60 °C (acc. to UL: 0 °C ... +55 °C)
	*Air flow during measurment	0,5m/s
	Storage temperature range	-40 °C ... +85 °C
	Humidity	10 ... 95% relative humidity, no condensation permitted
	Environment	For UL compliant usage: The device must be used in a pollution degree 2 environment.
Device	Dimensions (L x W x H)	120 x 89,9 x 18,5 mm (from hardware revision 3)
	Mounting/Installation	PCI Express x1 slot (3.3 V), refer to section <i>Slot for the PC Cards cifX PCI, PCIe and Low Profile PCIe</i> , page 43.
	RoHS	Yes
CE Sign	CE Sign	Yes
	Emission	EN 55011:2009 + A1:2010, CISPR 11:2009, Class A (Radio disturbance characteristics - Limits and methods of measurement)
	Immunity	EN 61000-4-2:2009 (Electrostatic discharge test) EN 61000-4-3:2006 + A1:2008 + A2:2010 (Radiated,

CIFX 50E-CC	Parameter	Value
		radio-frequency, electromagnetic field test EN 61000-4-4:2004 + A1:2010 (Burst Electrical fast transients/burst test) EN 61000-4-5:2006 (Surge test) EN 61000-4-6:2009 (to conducted disturbances, induced by radio- frequency fields) EN 61000-4-8:2010 (power frequency magnetic field test) EN 61000-6-2:2005 + B1:2011 (for industrial environments)
UL Certification	The device CIFX 50E-CC is certified according to UL 508.	UL-File-Nr. E221530
Configuration	Configuration Software	SYCON.net or netX Configuration Tool

Table 117: Technical Data CIFX 50E-CC

### 10.1.12 CIFX 50-2DP

CIFX 50-2DP	Parameter	Value
Part	Name	CIFX 50-2DP
	Part No.	1252.410
	Description	PC Card cifX PCI 2 channel PROFIBUS DP Master or Slave
	Function	Communication interface with PCI and 2 x PROFIBUS interface
Communication Controller	Type	netX 100 processor
Integrated Memory	RAM	8 MB SDRAM
	FLASH	4 MB serial Flash EPROM
	Size of the Dual-Port Memory	64 KByte
System Interface	Bus Type	PCI, according to [bus spec 1], refer to section <i>Overview</i> , page 145.
	Transmission Rate	33 MHz
	Data Access	DPM or DMA (Direct Memory Access)
	Width for the data access to the Dual-Port Memory (DPM)	32-Bit
PROFIBUS Communication	Supported communication standard/ protocol (determined by the loaded firmware)	PROFIBUS DP Master, PROFIBUS DP Slave
PROFIBUS Interface	Transmission rate	9,6 kBit/s, 19,2 kBit/s, 31,25 kBit/s, 45,45 kBit/s, 93,75 kBit/s, 187,5 kBit/s, 500 kBit/s, 1,5 MBit/s, 3 MBit/s, 6 MBit/s, 12 MBit/s
	Interface Type	2 * RS 485, refer to section <i>PROFIBUS Interface</i> p. 138.
	Galvanic Isolation	isolated
	Isolation Voltage	1000 VDC (tested for 1 minute)
	Connector	DSub female Connector, 9 pin

CIFX 50-2DP	Parameter	Value
Display	LED Display	<p><b>SYS</b> System Status LED</p> <p><b>COM 0</b> LED Communication Status 0 (duo LED) for channel X1</p> <p><b>COM 1</b> LED Communication Status 1 (duo LED) for channel X2</p> <p>The meaning of the LEDs COM0 and COM1 depends on the loaded firmware. Refer to ch. <i>LED Descriptions</i>, p. 102.</p>
Power supply	Supply Voltage	+3.3 V dc $\pm 5\%$ , refer to section <i>Power Supply and Host Interface</i> , page 44.
	Current consumption at 3.3 V	700 mA (maximum)
	Connector	Via PCI Bus
Operation	Rotary Switch Slot Number (Card ID)	To set the Slot Number (Card ID)
Environmental Conditions	Operating temperature range*	-20 °C ... +70 °C (acc. to UL: 0 °C ... +55 °C)
	*Air flow during measurement	0,5m/s
	Storage temperature range	-40 °C ... +85 °C
	Humidity	10 ... 95% relative humidity, no condensation permitted
	Environment	For UL compliant usage: The device must be used in a pollution degree 2 environment.
Device	Dimensions (L x W x H)	120 x 94,5 x 18,5 mm
	Mounting/Installation	PCI slot (3.3 V), refer to section <i>Slot for the PC Cards cifX PCI, PCIe and Low Profile PCIe</i> , page 43.
	RoHS	Yes
CE Sign	CE Sign	Yes
	Emission	EN 55011:2009 + A1:2010, CISPR 11:2009, Class A (Radio disturbance characteristics - Limits and methods of measurement)
	Immunity	<p>EN 61000-4-2:2009 (Electrostatic discharge test)</p> <p>EN 61000-4-3:2006 + A1:2008 + A2:2010 (Radiated, radio-frequency, electromagnetic field test)</p> <p>EN 61000-4-4:2004 + A1:2010 (Burst Electrical fast transients/burst test)</p> <p>EN 61000-4-5:2006 (Surge test)</p> <p>EN 61000-4-6:2009 (to conducted disturbances, induced by radio- frequency fields)</p> <p>EN 61000-4-8:2010 (power frequency magnetic field test)</p> <p>EN 61000-6-2:2005 + B1:2011 (for industrial environments)</p>
UL Certification	The device CIFX 50-2DP is certified according to UL 508.	UL-File-Nr. E221530
Configuration	Configuration Software Master	SYCON.net

Table 118: Technical Data CIFX 50-2DP

### 10.1.13 CIFX 50E-2DP

CIFX 50E-2DP	Parameter	Value
Part	Name	CIFX 50E-2DP
	Part No.	1253.410
	Description	PC Card cifX PCI Express 2 channel PROFIBUS DP Master or Slave

CIFX 50E-2DP	Parameter	Value
	Function	Communication interface with PCI Express and 2 x PROFIBUS interface
Communication Controller	Type	netX 100 processor
Integrated Memory	RAM	8 MB SDRAM
	FLASH	4 MB serial Flash EPROM
	Size of the Dual-Port Memory	64 KByte
System Interface	Bus Type	PCI Express, One Lane Port, according to [bus spec 2, Rev. 2.0] and [bus spec 3], refer to section <i>Overview</i> , page 145.
	Transmission Rate	2 GBit/s
	Data Access	DPM or DMA (Direct Memory Access)
	Width for the data access to the Dual-Port Memory (DPM)	32-Bit
PROFIBUS Communication	Supported communication standard/ protocol (determined by the loaded firmware)	PROFIBUS DP Master, PROFIBUS DP Slave
PROFIBUS Interface	Transmission rate	9,6 kBit/s, 19,2 kBit/s, 31,25 kBit/s, 45,45 kBit/s, 93,75 kBit/s, 187,5 kBit/s, 500 kBit/s, 1,5 MBit/s, 3 MBit/s, 6 MBit/s, 12 MBit/s
	Interface Type	RS 485, refer to section <i>PROFIBUS Interface</i> page 138.
	Galvanic Isolation	isolated
	Isolation Voltage	1000 VDC (tested for 1 minute)
	Connector	DSub female Connector, 9 pin
Display	LED Display	<p><b>SYS</b> System Status LED</p> <p><b>COM 0</b> LED Communication Status 0 (duo LED) for channel X1</p> <p><b>COM 1</b> LED Communication Status 1 (duo LED) for channel X2</p> <p>The meaning of the LEDs COM0 and COM1 depends on the loaded firmware. Refer to ch. <i>LED Descriptions</i>, p. 102.</p>
Power supply	Supply Voltage	+3.3 V dc $\pm 5\%$ , refer to section <i>Power Supply and Host Interface</i> , page 44.
	Current consumption at 3.3 V	840 mA (maximum)
	Connector	Via PCI Express Bus
Operation	Rotary Switch Slot Number (Card ID)	To set the Slot Number (Card ID)
Environmental Conditions	Operating temperature range*	-20 °C ... +70 °C
	*Air flow during measurment	0,5m/s
	Storage temperature range	-40 °C ... +85 °C
	Humidity	10 ... 95% relative humidity, no condensation permitted
	Environment	For UL compliant usage: The device must be used in a pollution degree 2 environment.
Device	Dimensions (L x W x H)	120,0 x 95 x 21,5 mm
	Mounting/Installation	PCI Express x1 slot (3.3 V), refer to section <i>Slot for the PC Cards cifX PCI, PCIe and Low Profile PCIe</i> , page 43.
	RoHS	Yes
CE Sign	CE Sign	Yes

CIFX 50E-2DP	Parameter	Value
	Emission	EN 55011:2009 + A1:2010, CISPR 11:2009, Class A (Radio disturbance characteristics - Limits and methods of measurement)
	Immunity	EN 61000-4-2:2009 (Electrostatic discharge test) EN 61000-4-3:2006 + A1:2008 + A2:2010 (Radiated, radio-frequency, electromagnetic field test) EN 61000-4-4:2004 + A1:2010 (Burst Electrical fast transients/burst test) EN 61000-4-5:2006 (Surge test) EN 61000-4-6:2009 (to conducted disturbances, induced by radio- frequency fields) EN 61000-4-8:2010 (power frequency magnetic field test) EN 61000-6-2:2005 + B1:2011 (for industrial environments)
Configuration	Configuration Software Master and Slave	SYCON.net
	Configuration Software Slave	netX Configuration Tool

Table 119: Technical Data CIFX 50E-DP

### 10.1.14 CIFX 50-2DP\CO

CIFX 50-2DP\CO	Parameter	Value
Part	Name	CIFX 50-2DP\CO
	Part No.	1252.470
	Description	PC Card cifX PCI 2 channel - Channel X0: PROFIBUS DP Master or Slave, Channel X1: CANopen Master or Slave
	Function	Communication interface with PCI, 1 x PROFIBUS and 1 x CANopen interface
Communication Controller	Type	netX 100 processor
Integrated Memory	RAM	8 MB SDRAM
	FLASH	4 MB serial Flash EPROM
	Size of the Dual-Port Memory	64 KByte
System Interface	Bus Type	PCI, according to [bus spec 1], refer to section <i>Overview</i> , page 145.
	Transmission Rate	33 MHz
	Data Access	DPM or DMA (Direct Memory Access)
	Width for the data access to the Dual-Port Memory (DPM)	32-Bit
PROFIBUS Communication	Supported communication standard/ protocol (determined by the loaded firmware)	PROFIBUS DP Master, PROFIBUS DP Slave
PROFIBUS Interface	Transmission rate	9,6 kBit/s, 19,2 kBit/s, 31,25 kBit/s, 45,45 kBit/s, 93,75 kBit/s, 187,5 kBit/s, 500 kBit/s, 1,5 MBit/s, 3 MBit/s, 6 MBit/s, 12 MBit/s
	Interface Type	2 * RS 485, refer to section <i>PROFIBUS Interface</i> p. 138.
	Galvanic Isolation	isolated
	Isolation Voltage	1000 VDC (tested for 1 minute)
	Connector	DSub female Connector, 9 pin
CANopen Communication	Supported communication standard/ protocol (determined by the loaded firmware)	CANopen Master, CANopen Slave
CANopen Interface	Transmission rate	10 kBit/s, 20 kBit/s, 50 kBit/s, 100 kBit/s, 125 kBit/s, 250 kBit/s, 500 kBit/s, 800 kBit/s, 1 MBit/s
	Interface Type	ISO-11898, refer to section <i>CANopen Interface</i> , page 138.
	Galvanic Isolation	optically isolated
	Isolation Voltage	1000 VDC (tested for 1 minute)
	Connector	DSub male Connector, 9 pin
Display	LED Display	<b>SYS</b> System Status LED <b>COM 0</b> LED Communication Status 0 (duo LED) for channel X1 <b>CAN 1</b> CANopen Status 1 (duo LED) for channel X2 The meaning of the LEDs COM0 and CAN1 depends on the loaded firmware. Refer to chapter <i>LED Descriptions</i> , page 102.
Power supply	Supply Voltage	+3.3 V dc $\pm 5\%$ , refer to section <i>Power Supply and Host Interface</i> , page 44.
	Current consumption at 3.3 V	700 mA (maximum)
	Connector	Via PCI Bus
Operation	Rotary Switch Slot Number (Card ID)	To set the Slot Number (Card ID)



CIFX 50-2DP\CO	Parameter	Value
Environmental Conditions	Operating temperature range*	-20 °C ... +70°C
	*Air flow during measurment	0,5m/s
	Storage temperature range	-40 °C ... +85 °C
	Humidity	10 ... 95% relative humidity, no condensation permitted
	Environment	For UL compliant usage: The device must be used in a pollution degree 2 environment.
Device	Dimensions (L x W x H)	120 x 94,5 x 18,5 mm
	Mounting/Installation	PCI slot (3.3 V), refer to section <i>Slot for the PC Cards cifX PCI, PCIe and Low Profile PCIe</i> , page 43.
	RoHS	Yes
CE Sign	CE Sign	Yes
	Emission	EN 55011:2009 + A1:2010, CISPR 11:2009, Class A (Radio disturbance characteristics - Limits and methods of measurement)
	Immunity	EN 61000-4-2:2009 (Electrostatic discharge test) EN 61000-4-3:2006 + A1:2008 + A2:2010 (Radiated, radio-frequency, electromagnetic field test) EN 61000-4-4:2004 + A1:2010 (Burst Electrical fast transients/burst test) EN 61000-4-5:2006 (Surge test) EN 61000-4-6:2009 (to conducted disturbances, induced by radio- frequency fields) EN 61000-4-8:2010 (power frequency magnetic field test) EN 61000-6-2:2005 + B1:2011 (for industrial environments)
Configuration	Configuration Software Master	SYCON.net

Table 120: Technical Data CIFX 50-2DP\CO

### 10.1.15 CIFX 50E-2DP\CO

CIFX 50E-2DP\CO	Parameter	Value
Part	Name	CIFX 50E-2DP\CO
	Part No.	1253.470
	Description	PC Card cifX PCI 2 channel - Channel X0: PROFIBUS DP Master or Slave, Channel X1: CANopen Master or Slave
	Function	Communication interface with PCI Express, 1 x PROFIBUS and 1 x CANopen interface
Communication Controller	Type	netX 100 processor
Integrated Memory	RAM	8 MB SDRAM
	FLASH	4 MB serial Flash EPROM
	Size of the Dual-Port Memory	64 KByte
System Interface	Bus Type	PCI Express, One Lane Port, according to [bus spec 2, Rev. 2.0] and [bus spec 3], refer to section <i>Overview</i> , page 145.
	Transmission Rate	2 GBit/s
	Data Access	DPM or DMA (Direct Memory Access)
	Width for the data access to the Dual-Port Memory (DPM)	32-Bit

CIFX 50E-2DP\CO	Parameter	Value
PROFIBUS Communication	Supported communication standard/ protocol (determined by the loaded firmware)	PROFIBUS DP Master, PROFIBUS DP Slave
PROFIBUS Interface	Transmission rate	9,6 kBit/s, 19,2 kBit/s, 31,25 kBit/s, 45,45 kBit/s, 93,75 kBit/s, 187,5 kBit/s, 500 kBit/s, 1,5 MBit/s, 3 MBit/s, 6 MBit/s, 12 MBit/s
	Interface Type	2 * RS 485, refer to section <i>PROFIBUS Interface</i> p. 138.
	Galvanic Isolation	isolated
	Isolation Voltage	1000 VDC (tested for 1 minute)
	Connector	DSub female Connector, 9 pin
CANopen Communication	Supported communication standard/ protocol (determined by the loaded firmware)	CANopen Master, CANopen Slave
CANopen Interface	Transmission rate	10 kBit/s, 20 kBit/s, 50 kBit/s, 100 kBit/s, 125 kBit/s, 250 kBit/s, 500 kBit/s, 800 kBit/s, 1 MBit/s
	Interface Type	ISO-11898, refer to section <i>CANopen Interface</i> , page 138.
	Galvanic Isolation	optically isolated
	Isolation Voltage	1000 VDC (tested for 1 minute)
	Connector	DSub male Connector, 9 pin
Display	LED Display	<p><b>SYS</b> System Status LED</p> <p><b>COM 0</b> LED Communication Status 0 (duo LED) for channel X1</p> <p><b>CAN 1</b> CANopen Status 1 (duo LED) for channel X2</p> <p>The meaning of the LEDs COM0 and CAN1 depends on the loaded firmware. Refer to chapter <i>LED Descriptions</i>, page 102.</p>
Power supply	Supply Voltage	+3.3 V dc $\pm 5\%$ , refer to section <i>Power Supply and Host Interface</i> , page 44.
	Current consumption at 3.3 V	750 mA (maximum)
	Connector	Via PCI Express Bus
Operation	Rotary Switch Slot Number (Card ID)	To set the Slot Number (Card ID)
Environmental Conditions	Operating temperature range*	-20 °C ... +70°C
	*Air flow during measurement	0,5m/s
	Storage temperature range	-40 °C ... +85 °C
	Humidity	10 ... 95% relative humidity, no condensation permitted
	Environment	For UL compliant usage: The device must be used in a pollution degree 2 environment.
Device	Dimensions (L x W x H)	120,0 x 95 x 21,5 mm
	Mounting/Installation	PCI slot (3.3 V), refer to section <i>Slot for the PC Cards cifX PCI, PCIe and Low Profile PCIe</i> , page 43.
	RoHS	Yes
CE Sign	CE Sign	Yes
	Emission	EN 55011:2009 + A1:2010, CISPR 11:2009, Class A (Radio disturbance characteristics - Limits and methods of measurement)
	Immunity	EN 61000-4-2:2009 (Electrostatic discharge test) EN 61000-4-3:2006 + A1:2008 + A2:2010 (Radiated, radio-frequency, electromagnetic field test) EN 61000-4-4:2004 + A1:2010 (Burst Electrical fast transients/burst test)

CIFX 50E-2DP\CO	Parameter	Value
		EN 61000-4-5:2006 (Surge test) EN 61000-4-6:2009 (to conducted disturbances, induced by radio- frequency fields) EN 61000-4-8:2010 (power frequency magnetic field test) EN 61000-6-2:2005 + B1:2011 (for industrial environments)
Configuration	Configuration Software Master	SYCON.net

Table 121: Technical Data CIFX 50E-2DP\CO

### 10.1.16 CIFX 50-2DP\DN

CIFX 50-2DP\DN	Parameter	Value
Part	Name	CIFX 50-2DP\DN
	Part No.	1252.480
	Description	PC Card cifX PCI 2 channel - Channel X0: PROFIBUS DP Master or Slave, Channel X1: DeviceNet Master or Slave
	Function	Communication interface with PCI, 1 x PROFIBUS and 1 x DeviceNet interface
Communication Controller	Type	netX 100 processor
Integrated Memory	RAM	8 MB SDRAM
	FLASH	4 MB serial Flash EPROM
	Size of the Dual-Port Memory	64 KByte
System Interface	Bus Type	PCI, according to [bus spec 1], refer to section <i>Overview</i> , page 145.
	Transmission Rate	33 MHz
	Data Access	DPM or DMA (Direct Memory Access)
	Width for the data access to the Dual-Port Memory (DPM)	32-Bit
PROFIBUS Communication	Supported communication standard/ protocol (determined by the loaded firmware)	PROFIBUS DP Master, PROFIBUS DP Slave
PROFIBUS Interface	Transmission rate	9,6 kBit/s, 19,2 kBit/s, 31,25 kBit/s, 45,45 kBit/s, 93,75 kBit/s, 187,5 kBit/s, 500 kBit/s, 1,5 MBit/s, 3 MBit/s, 6 MBit/s, 12 MBit/s
	Interface Type	2 * RS 485, refer to section <i>PROFIBUS Interface</i> p. 138.
	Galvanic Isolation	isolated
	Isolation Voltage	1000 VDC (tested for 1 minute)
	Connector	DSub female Connector, 9 pin
DeviceNet Communication	Supported communication standard/ protocol (determined by the loaded firmware)	DeviceNet Master, DeviceNet Slave
DeviceNet Interface	Transmission rate	125 kBit/s, 250 kBit/s, 500 kBit/s
	Interface Type	ISO-11898 according to DeviceNet specification, refer to section <i>DeviceNet Interface</i> , page 139.
	Galvanic Isolation	optically isolated
	Isolation Voltage	1000 VDC (tested for 1 minute)
	Connector	CombiCon male Connector, 5 pin
Display	LED Display	<b>SYS</b> System Status LED <b>COM 0</b> LED Communication Status 0 (duo LED) for channel X1

CIFX 50-2DP\DN	Parameter	Value
		<b>MNS 1</b> DeviceNet-Status 1 (duo LED) for channel X2 The meaning of the LEDs COM0 and MNS1 depends on the loaded firmware. Refer to chapter <i>LED Descriptions</i> , page 102.
Power supply	Supply Voltage	+3.3 V dc $\pm 5\%$ , refer to section <i>Power Supply and Host Interface</i> , page 44.
	Current consumption at 3.3 V	700 mA (maximum)
	Connector	Via PCI Bus
Operation	Rotary Switch Slot Number (Card ID)	To set the Slot Number (Card ID)
Environmental Conditions	Operating temperature range*	-20 °C ... +70 °C
	*Air flow during measurment	0,5m/s
	Storage temperature range	-40 °C ... +85 °C
	Humidity	10 ... 95% relative humidity, no condensation permitted
	Environment	For UL compliant usage: The device must be used in a pollution degree 2 environment.
Device	Dimensions (L x W x H)	120 x 94,5 x 18,5 mm
	Mounting/Installation	PCI slot (3.3 V), refer to section <i>Slot for the PC Cards cifX PCI, PCIe and Low Profile PCIe</i> , page 43.
	RoHS	Yes
CE Sign	CE Sign	Yes
	Emission	EN 55011:2009 + A1:2010, CISPR 11:2009, Class A (Radio disturbance characteristics - Limits and methods of measurement)
	Immunity	EN 61000-4-2:2009 (Electrostatic discharge test) EN 61000-4-3:2006 + A1:2008 + A2:2010 (Radiated, radio-frequency, electromagnetic field test) EN 61000-4-4:2004 + A1:2010 (Burst Electrical fast transients/burst test) EN 61000-4-5:2006 (Surge test) EN 61000-4-6:2009 (to conducted disturbances, induced by radio- frequency fields) EN 61000-4-8:2010 (power frequency magnetic field test) EN 61000-6-2:2005 + B1:2011 (for industrial environments)
Configuration	Configuration Software Master	SYCON.net

Table 122: Technical Data CIFX 50-2DP\DN

### 10.1.17 CIFX 50E-2DP\DN

CIFX 50E-2DP\DN	Parameter	Value
Part	Name	CIFX 50E-2DP\DN
	Part No.	1253.480
	Description	PC Card cifX PCI 2 channel - Channel X0: PROFIBUS DP Master or Slave, Channel X1: DeviceNet Master or Slave
	Function	Communication interface with PCI Express, 1 x PROFIBUS and 1 x DeviceNet interface
Communication Controller	Type	netX 100 processor
Integrated Memory	RAM	8 MB SDRAM

CIFX 50E-2DP\DN	Parameter	Value
	FLASH	4 MB serial Flash EPROM
	Size of the Dual-Port Memory	64 KByte
System Interface	Bus Type	PCI Express, One Lane Port, according to [bus spec 2, Rev. 2.0] and [bus spec 3], refer to section <i>Overview</i> , page 145.
	Transmission Rate	2 GBit/s
	Data Access	DPM or DMA (Direct Memory Access)
	Width for the data access to the Dual-Port Memory (DPM)	32-Bit
PROFIBUS Communication	Supported communication standard/ protocol (determined by the loaded firmware)	PROFIBUS DP Master, PROFIBUS DP Slave
PROFIBUS Interface	Transmission rate	9,6 kBit/s, 19,2 kBit/s, 31,25 kBit/s, 45,45 kBit/s, 93,75 kBit/s, 187,5 kBit/s, 500 kBit/s, 1,5 MBit/s, 3 MBit/s, 6 MBit/s, 12 MBit/s
	Interface Type	2 * RS 485, refer to section <i>PROFIBUS Interface</i> p. 138.
	Galvanic Isolation	isolated
	Isolation Voltage	1000 VDC (tested for 1 minute)
	Connector	DSub female Connector, 9 pin
DeviceNet Communication	Supported communication standard/ protocol (determined by the loaded firmware)	DeviceNet Master, DeviceNet Slave
DeviceNet Interface	Transmission rate	125 kBit/s, 250 kBit/s, 500 kBit/s
	Interface Type	ISO-11898 according to DeviceNet specification, refer to section <i>DeviceNet Interface</i> , page 139.
	Galvanic Isolation	optically isolated
	Isolation Voltage	1000 VDC (tested for 1 minute)
	Connector	CombiCon male Connector, 5 pin
Display	LED Display	<p><b>SYS</b> System Status LED</p> <p><b>COM 0</b> LED Communication Status 0 (duo LED) for channel X1</p> <p><b>MNS 1</b> DeviceNet-Status 1 (duo LED) for channel X2</p> <p>The meaning of the LEDs COM0 and MNS1 depends on the loaded firmware. Refer to chapter <i>LED Descriptions</i>, page 102.</p>
Power supply	Supply Voltage	+3.3 V dc $\pm$ 5 %, refer to section <i>Power Supply and Host Interface</i> , page 44.
	Current consumption at 3.3 V	800 mA (maximum)
	Connector	Via PCI Express Bus
Operation	Rotary Switch Slot Number (Card ID)	To set the Slot Number (Card ID)
Environmental Conditions	Operating temperature range*	-20 °C ... +70 °C
	*Air flow during measurment	0,5m/s
	Storage temperature range	-40 °C ... +85 °C
	Humidity	10 ... 95% relative humidity, no condensation permitted
	Environment	For UL compliant usage: The device must be used in a pollution degree 2 environment.
Device	Dimensions (L x W x H)	120,0 x 95 x 21,5 mm
	Mounting/Installation	PCI slot (3.3 V), refer to section <i>Slot for the PC Cards cifX PCI, PCIe and Low Profile PCIe</i> , page 43.
	RoHS	Yes

CIFX 50E-2DP\DN	Parameter	Value
CE Sign	CE Sign	Yes
	Emission	EN 55011:2009 + A1:2010, CISPR 11:2009, Class A (Radio disturbance characteristics - Limits and methods of measurement)
	Immunity	EN 61000-4-2:2009 (Electrostatic discharge test) EN 61000-4-3:2006 + A1:2008 + A2:2010 (Radiated, radio-frequency, electromagnetic field test) EN 61000-4-4:2004 + A1:2010 (Burst Electrical fast transients/burst test) EN 61000-4-5:2006 (Surge test) EN 61000-4-6:2009 (to conducted disturbances, induced by radio- frequency fields) EN 61000-4-8:2010 (power frequency magnetic field test) EN 61000-6-2:2005 + B1:2011 (for industrial environments)
Configuration	Configuration Software Master	SYCON.net

Table 123: Technical Data CIFX 50-2DP\DN

### 10.1.18 CIFX 50-2CO

CIFX 50-2CO	Parameter	Value
Part	Name	CIFX 50-2CO
	Part No.	1252.500
	Description	PC Card cifX PCI 2 channel CANopen Master or Slave
	Function	Communication interface with PCI and 2 x CANopen interface
Communication Controller	Type	netX 100 processor
Integrated Memory	RAM	8 MB SDRAM
	FLASH	4 MB serial Flash EPROM
	Size of the Dual-Port Memory	64 KByte
System Interface	Bus Type	PCI, according to [bus spec 1], refer to section <i>Overview</i> , page 145.
	Transmission Rate	33 MHz
	Data Access	DPM or DMA (Direct Memory Access)
	Width for the data access to the Dual-Port Memory (DPM)	32-Bit
CANopen Communication	Supported communication standard/ protocol (determined by the loaded firmware)	CANopen Master, CANopen Slave
CANopen Interface	Transmission rate	10 kBit/s, 20 kBit/s, 50 kBit/s, 100 kBit/s, 125 kBit/s, 250 kBit/s, 500 kBit/s, 800 kBit/s, 1 MBit/s
	Interface Type	ISO-11898, refer to section <i>CANopen Interface</i> , page 138.
	Galvanic Isolation	optically isolated
	Isolation Voltage	1000 VDC (tested for 1 minute)
	Connector	DSub male Connector, 9 pin
Display	LED Display	<b>SYS</b> System Status LED <b>CAN 0</b> CANopen Status 0 (duo LED) for channel X1 <b>CAN 1</b> CANopen Status 1 (duo LED) for channel X2 The meaning of the LEDs CAN0 and CAN1 depends on the loaded firmware. Refer to chapter <i>LED Descriptions</i> , page 102.

CIFX 50-2CO	Parameter	Value
Power supply	Supply Voltage	+3.3 V dc $\pm$ 5 %, refer to section <i>Power Supply and Host Interface</i> , page 44.
	Current consumption at 3.3 V	700 mA (maximum)
	Connector	Via PCI Bus
Operation	Rotary Switch Slot Number (Card ID)	To set the Slot Number (Card ID)
Environmental Conditions	Operating temperature range*	-20 °C ... +70 °C
	*Air flow during measurement	0,5m/s
	Storage temperature range	-40 °C ... +85 °C
	Humidity	10 ... 95% relative humidity, no condensation permitted
	Environment	For UL compliant usage: The device must be used in a pollution degree 2 environment.
Device	Dimensions (L x W x H)	120 x 94,5 x 18,5 mm
	Mounting/Installation	PCI slot (3.3 V), refer to section <i>Slot for the PC Cards cifX PCI, PCIe and Low Profile PCIe</i> , page 43.
	RoHS	Yes
CE Sign	CE Sign	Yes
	Emission	EN 55011:2009 + A1:2010, CISPR 11:2009, Class A (Radio disturbance characteristics - Limits and methods of measurement)
	Immunity	EN 61000-4-2:2009 (Electrostatic discharge test) EN 61000-4-3:2006 + A1:2008 + A2:2010 (Radiated, radio-frequency, electromagnetic field test) EN 61000-4-4:2004 + A1:2010 (Burst Electrical fast transients/burst test) EN 61000-4-5:2006 (Surge test) EN 61000-4-6:2009 (to conducted disturbances, induced by radio- frequency fields) EN 61000-4-8:2010 (power frequency magnetic field test) EN 61000-6-2:2005 + B1:2011 (for industrial environments)
Configuration	Configuration Software Master	SYCON.net

Table 124: Technical Data CIFX 50-2CO

### 10.1.19 CIFX 50E-2CO

CIFX 50E-2CO	Parameter	Value
Part	Name	CIFX 50E-2CO
	Part No.	1253.500
	Description	PC Card cifX PCI Express 2 channel CANopen Master or Slave
	Function	Communication interface with PCI Express and 2 x CANopen interface
Communication Controller	Type	netX 100 processor
Integrated Memory	RAM	8 MB SDRAM
	FLASH	4 MB serial Flash EPROM
	Size of the Dual-Port Memory	64 KByte
System Interface	Bus Type	PCI Express, One Lane Port, according to [bus spec 2, Rev. 2.0] and [bus spec 3], refer to section <i>Overview</i> , page 145.

CIFX 50E-2CO	Parameter	Value
	Transmission Rate	2 GBit/s
	Data Access	DPM or DMA* (Direct Memory Access); *beginning from Hardware Revision 4
	Width for the data access to the Dual-Port Memory (DPM)	32-Bit
CANopen Communication	Supported communication standard/ protocol (determined by the loaded firmware)	CANopen Master, CANopen Slave
CANopen Interface	Transmission rate	10 kBit/s, 20 kBit/s, 50 kBit/s, 100 kBit/s, 125 kBit/s, 250 kBit/s, 500 kBit/s, 800 kBit/s, 1 MBit/s
	Interface Type	ISO-11898, refer to section <i>CANopen Interface</i> , page 138.
	Galvanic Isolation	optically isolated
	Isolation Voltage	1000 VDC (tested for 1 minute)
	Connector	DSub male Connector, 9 pin
Display	LED Display	<p><b>SYS</b>            System Status LED</p> <p><b>CAN 0</b>        CANopen Status 0 (duo LED) for channel X1</p> <p><b>CAN 1</b>        CANopen Status 1 (duo LED) for channel X2</p> <p>The meaning of the LEDs CAN0 and CAN1 depends on the loaded firmware. Refer to chapter <i>LED Descriptions</i>, page 102.</p>
Power supply	Supply Voltage	+3.3 V dc $\pm$ 5 %, refer to section <i>Power Supply and Host Interface</i> , page 44.
	Current consumption at 3.3 V	750 mA (maximum)
	Connector	Via PCI Express Bus
Operation	Rotary Switch Slot Number (Card ID)	To set the Slot Number (Card ID)
Environmental Conditions	Operating temperature range*	-20 °C ... +70 °C
	*Air flow during measurement	0,5m/s
	Storage temperature range	-40 °C ... +85 °C
	Humidity	10 ... 95% relative humidity, no condensation permitted
	Environment	For UL compliant usage: The device must be used in a pollution degree 2 environment.
Device	Dimensions (L x W x H)	120,0 x 95 x 21,5 mm
	Mounting/Installation	PCI Express x1 slot (3.3 V), refer to section <i>Slot for the PC Cards cifX PCI, PCIe and Low Profile PCIe</i> , page 43.
	RoHS	Yes
CE Sign	CE Sign	Yes
	Emission	EN 55011:2009 + A1:2010, CISPR 11:2009, Class A (Radio disturbance characteristics - Limits and methods of measurement)
	Immunity	<p>EN 61000-4-2:2009 (Electrostatic discharge test)</p> <p>EN 61000-4-3:2006 + A1:2008 + A2:2010 (Radiated, radio-frequency, electromagnetic field test)</p> <p>EN 61000-4-4:2004 + A1:2010 (Burst Electrical fast transients/burst test)</p> <p>EN 61000-4-5:2006 (Surge test)</p> <p>EN 61000-4-6:2009 (to conducted disturbances, induced by radio- frequency fields)</p> <p>EN 61000-4-8:2010 (power frequency magnetic field test)</p>



CIFX 50E-2CO	Parameter	Value
		EN 61000-6-2:2005 + B1:2011 (for industrial environments)
Configuration	Configuration Software Master and Slave	SYCON.net
	Configuration Software Slave	netX Configuration Tool

Table 125: Technical Data CIFX 50E-2CO

### 10.1.20 CIFX 50-2CO\DN

CIFX 50-2CO\DN	Parameter	Value
Part	Name	CIFX 50-2CO\DN
	Part No.	1252.570
	Description	PC Card cifX PCI 2 channel - Channel X0: CANopen Master or Slave, Channel X1: DeviceNet Master or Slave
	Function	Communication interface with PCI, 1 x CANopen and 1 x DeviceNet interface
Communication Controller	Type	netX 100 processor
Integrated Memory	RAM	8 MB SDRAM
	FLASH	4 MB serial Flash EPROM
	Size of the Dual-Port Memory	64 KByte
System Interface	Bus Type	PCI, according to [bus spec 1], refer to section <i>Overview</i> , page 145.
	Transmission Rate	33 MHz
	Data Access	DPM or DMA (Direct Memory Access)
	Width for the data access to the Dual-Port Memory (DPM)	32-Bit
CANopen Communication	Supported communication standard/ protocol (determined by the loaded firmware)	CANopen Master, CANopen Slave
CANopen Interface	Transmission rate	10 kBit/s, 20 kBit/s, 50 kBit/s, 100 kBit/s, 125 kBit/s, 250 kBit/s, 500 kBit/s, 800 kBit/s, 1 MBit/s
	Interface Type	ISO-11898, refer to section <i>CANopen Interface</i> , page 138.
	Galvanic Isolation	optically isolated
	Isolation Voltage	1000 VDC (tested for 1 minute)
	Connector	DSub male Connector, 9 pin
DeviceNet Communication	Supported communication standard/ protocol (determined by the loaded firmware)	DeviceNet Master, DeviceNet Slave
DeviceNet Interface	Transmission rate	125 kBit/s, 250 kBit/s, 500 kBit/s
	Interface Type	ISO-11898 according to DeviceNet specification, refer to section <i>DeviceNet Interface</i> , page 139.
	Galvanic Isolation	optically isolated
	Isolation Voltage	1000 VDC (tested for 1 minute)
	Connector	CombiCon male Connector, 5 pin
Display	LED Display	<p><b>SYS</b> System Status LED</p> <p><b>CAN 0</b> CANopen Status 0 (duo LED) for channel X1</p> <p><b>MNS 1</b> CANopen Status 1 (duo LED) for channel X2</p> <p>The meaning of the LEDs CAN0 and MNS1 depends on the loaded firmware. Refer to chapter <i>LED Descriptions</i>, page 102.</p>

CIFX 50-2CO\DN	Parameter	Value
Power supply	Supply Voltage	+3.3 V dc $\pm$ 5 %, refer to section <i>Power Supply and Host Interface</i> , page 44.
	Current consumption at 3.3 V	700 mA (maximum)
	Connector	Via PCI Bus
Operation	Rotary Switch Slot Number (Card ID)	To set the Slot Number (Card ID)
Environmental Conditions	Operating temperature range*	-20 °C ... +70 °C
	*Air flow during measurement	0,5m/s
	Storage temperature range	-40 °C ... +85 °C
	Humidity	10 ... 95% relative humidity, no condensation permitted
	Environment	For UL compliant usage: The device must be used in a pollution degree 2 environment.
Device	Dimensions (L x W x H)	120 x 94,5 x 18,5 mm
	Mounting/Installation	PCI slot (3.3 V), refer to section <i>Slot for the PC Cards cifX PCI, PCIe and Low Profile PCIe</i> , page 43.
	RoHS	Yes
CE Sign	CE Sign	Yes
	Emission	EN 55011:2009 + A1:2010, CISPR 11:2009, Class A (Radio disturbance characteristics - Limits and methods of measurement)
	Immunity	EN 61000-4-2:2009 (Electrostatic discharge test) EN 61000-4-3:2006 + A1:2008 + A2:2010 (Radiated, radio-frequency, electromagnetic field test) EN 61000-4-4:2004 + A1:2010 (Burst Electrical fast transients/burst test) EN 61000-4-5:2006 (Surge test) EN 61000-4-6:2009 (to conducted disturbances, induced by radio- frequency fields) EN 61000-4-8:2010 (power frequency magnetic field test) EN 61000-6-2:2005 + B1:2011 (for industrial environments)
Configuration	Configuration Software Master	SYCON.net

Table 126: Technical Data CIFX 50-2CO\DN

### 10.1.21 CIFX 50E-2CO\DN

CIFX 50E-2CO\DN	Parameter	Value
Part	Name	CIFX 50E-2CO\DN
	Part No.	1253.570
	Description	PC Card cifX PCI 2 channel - Channel X0: CANopen Master or Slave, Channel X1: DeviceNet Master or Slave
	Function	Communication interface with PCI Express, 1 x CANopen and 1 x DeviceNet interface
Communication Controller	Type	netX 100 processor
Integrated Memory	RAM	8 MB SDRAM
	FLASH	4 MB serial Flash EPROM
	Size of the Dual-Port Memory	64 KByte
System Interface	Bus Type	PCI Express, One Lane Port, according to [bus spec 2, Rev. 2.0] and [bus spec 3], refer to section <i>Overview</i> ,

CIFX 50E-2CO\DN	Parameter	Value
		page 145.
	Transmission Rate	2 GBit/s
	Data Access	DPM or DMA (Direct Memory Access)
	Width for the data access to the Dual-Port Memory (DPM)	32-Bit
CANopen Communication	Supported communication standard/ protocol (determined by the loaded firmware)	CANopen Master, CANopen Slave
CANopen Interface	Transmission rate	10 kBit/s, 20 kBit/s, 50 kBit/s, 100 kBit/s, 125 kBit/s, 250 kBit/s, 500 kBit/s, 800 kBit/s, 1 MBit/s
	Interface Type	ISO-11898, refer to section <i>CANopen Interface</i> , page 138.
	Galvanic Isolation	optically isolated
	Isolation Voltage	1000 VDC (tested for 1 minute)
	Connector	DSub male Connector, 9 pin
DeviceNet Communication	Supported communication standard/ protocol (determined by the loaded firmware)	DeviceNet Master, DeviceNet Slave
DeviceNet Interface	Transmission rate	125 kBit/s, 250 kBit/s, 500 kBit/s
	Interface Type	ISO-11898 according to DeviceNet specification, refer to section <i>DeviceNet Interface</i> , page 139.
	Galvanic Isolation	optically isolated
	Isolation Voltage	1000 VDC (tested for 1 minute)
	Connector	CombiCon male Connector, 5 pin
Display	LED Display	<p><b>SYS</b> System Status LED</p> <p><b>CAN 0</b> CANopen Status 0 (duo LED) for channel X1</p> <p><b>MNS 1</b> CANopen Status 1 (duo LED) for channel X2</p> <p>The meaning of the LEDs CAN0 and MNS1 depends on the loaded firmware. Refer to chapter <i>LED Descriptions</i>, page 102.</p>
Power supply	Supply Voltage	+3.3 V dc $\pm 5\%$ , refer to section <i>Power Supply and Host Interface</i> , page 44.
	Current consumption at 3.3 V	780 mA (maximum)
	Connector	Via PCI Express Bus
Operation	Rotary Switch Slot Number (Card ID)	To set the Slot Number (Card ID)
Environmental Conditions	Operating temperature range*	-20 °C ... +70 °C
	*Air flow during measurement	0,5m/s
	Storage temperature range	-40 °C ... +85 °C
	Humidity	10 ... 95% relative humidity, no condensation permitted
	Environment	For UL compliant usage: The device must be used in a pollution degree 2 environment.
Device	Dimensions (L x W x H)	120,0 x 95 x 21,5 mm
	Mounting/Installation	PCI slot (3.3 V), refer to section <i>Slot for the PC Cards cifX PCI, PCIe and Low Profile PCIe</i> , page 43.
	RoHS	Yes
CE Sign	CE Sign	Yes
	Emission	EN 55011:2009 + A1:2010, CISPR 11:2009, Class A (Radio disturbance characteristics - Limits and methods of measurement)
	Immunity	EN 61000-4-2:2009 (Electrostatic discharge test)

CIFX 50E-2CO\DN	Parameter	Value
		EN 61000-4-3:2006 + A1:2008 + A2:2010 (Radiated, radio-frequency, electromagnetic field test) EN 61000-4-4:2004 + A1:2010 (Burst Electrical fast transients/burst test) EN 61000-4-5:2006 (Surge test) EN 61000-4-6:2009 (to conducted disturbances, induced by radio- frequency fields) EN 61000-4-8:2010 (power frequency magnetic field test) EN 61000-6-2:2005 + B1:2011 (for industrial environments)
Configuration	Configuration Software Master	SYCON.net

Table 127: Technical Data CIFX 50E-2CO\DN

### 10.1.22 CIFX 50-2DN

CIFX 50-2DN	Parameter	Value
Part	Name	CIFX 50-2DN
	Part No.	1252.510
	Description	PC Card cifX PCI 2 channel DeviceNet Master or Slave
	Function	Communication interface with PCI and 2 x DeviceNet interface
Communication Controller	Type	netX 100 processor
Integrated Memory	RAM	8 MB SDRAM
	FLASH	4 MB serial Flash EPROM
	Size of the Dual-Port Memory	64 KByte
System Interface	Bus Type	PCI, according to [bus spec 1], refer to section <i>Overview</i> , page 145.
	Transmission Rate	33 MHz
	Data Access	DPM or DMA (Direct Memory Access)
	Width for the data access to the Dual-Port Memory (DPM)	32-Bit
DeviceNet Communication	Supported communication standard/ protocol (determined by the loaded firmware)	DeviceNet Master, DeviceNet Slave
DeviceNet Interface	Transmission rate	125 kBit/s, 250 kBit/s, 500 kBit/s
	Interface Type	ISO-11898 according to DeviceNet specification, refer to section <i>DeviceNet Interface</i> , page 139.
	Galvanic Isolation	optically isolated
	Isolation Voltage	1000 VDC (tested for 1 minute)
	Connector	CombiCon male Connector, 5 pin
Display	LED Display	<b>SYS</b> System Status LED <b>MNS 0</b> Module Network Status 0 (duo LED) for channel X1 <b>MNS 1</b> Module Network Status 1 (duo LED) for channel X2  The meaning of the LEDs MNS 0 and MNS 1 depends on the loaded firmware. Refer to chapter <i>LED Descriptions</i> , page 102.
Power supply	Supply Voltage	+3.3 V dc ±5 %, refer to section <i>Power Supply and Host Interface</i> , page 44.

CIFX 50-2DN	Parameter	Value
	Current consumption at 3.3 V	700 mA (maximum)
	Connector	Via PCI Bus
Operation	Rotary Switch Slot Number (Card ID)	To set the Slot Number (Card ID)
Environmental Conditions	Operating temperature range*	-20 °C ... +70 °C
	*Air flow during measurement	0,5m/s
	Storage temperature range	-40 °C ... +85 °C
	Humidity	10 ... 95% relative humidity, no condensation permitted
	Environment	For UL compliant usage: The device must be used in a pollution degree 2 environment.
Device	Dimensions (L x W x H)	120 x 94,5 x 18,5 mm
	Mounting/Installation	PCI slot (3.3 V), refer to section <i>Slot for the PC Cards cifX PCI, PCIe and Low Profile PCIe</i> , page 43.
	RoHS	Yes
CE Sign	CE Sign	Yes
	Emission	EN 55011:2009 + A1:2010, CISPR 11:2009, Class A (Radio disturbance characteristics - Limits and methods of measurement)
	Immunity	EN 61000-4-2:2009 (Electrostatic discharge test) EN 61000-4-3:2006 + A1:2008 + A2:2010 (Radiated, radio-frequency, electromagnetic field test) EN 61000-4-4:2004 + A1:2010 (Burst Electrical fast transients/burst test) EN 61000-4-5:2006 (Surge test) EN 61000-4-6:2009 (to conducted disturbances, induced by radio- frequency fields) EN 61000-4-8:2010 (power frequency magnetic field test) EN 61000-6-2:2005 + B1:2011 (for industrial environments)
Configuration	Configuration Software Master	SYCON.net

Table 128: Technical Data CIFX 50-2DN

### 10.1.23 CIFX 50E-2DN

CIFX 50E-2DN	Parameter	Value
Part	Name	CIFX 50E-2DN
	Part No.	1253.510
	Description	PC Card cifX PCI 2 channel ExpressDeviceNet Master or Slave
	Function	Communication interface with PCI Express and 2x DeviceNet interface
Communication Controller	Type	netX 100 processor
Integrated Memory	RAM	8 MB SDRAM
	FLASH	4 MB serial Flash EPROM
	Size of the Dual-Port Memory	64 KByte
System Interface	Bus Type	PCI Express, One Lane Port, according to [bus spec 2, Rev. 2.0] and [bus spec 3], refer to section <i>Overview</i> , page 145.
	Transmission Rate	2 GBit/s

CIFX 50E-2DN	Parameter	Value
	Data Access	DPM or DMA (Direct Memory Access)
	Width for the data access to the Dual-Port Memory (DPM)	32-Bit
DeviceNet Communication	Supported communication standard/ protocol (determined by the loaded firmware)	DeviceNet Master, DeviceNet Slave
DeviceNet Interface	Transmission rate	125 kBit/s, 250 kBit/s, 500 kBit/s
	Interface Type	ISO-11898 according to DeviceNet specification, refer to section <i>DeviceNet Interface</i> , page 139.
	Galvanic Isolation	optically isolated
	Isolation Voltage	1000 VDC (tested for 1 minute)
	Connector	CombiCon male Connector, 5 pin
Display	LED Display	<p><b>SYS</b> System Status LED</p> <p><b>MNS 0</b> Module Network Status 0 (duo LED) for channel X1</p> <p><b>MNS 1</b> Module Network Status 1 (duo LED) for channel X2</p> <p>The meaning of the LEDs MNS 0 and MNS 1 depends on the loaded firmware. Refer to chapter <i>LED Descriptions</i>, page 102.</p>
Power supply	Supply Voltage	+3.3 V dc $\pm 5\%$ , refer to section <i>Power Supply and Host Interface</i> , page 44.
	Current consumption at 3.3 V	880 mA (maximum)
	Connector	Via PCI Express Bus
Operation	Rotary Switch Slot Number (Card ID)	To set the Slot Number (Card ID)
Environmental Conditions	Operating temperature range*	-20 °C ... +70 °C
	*Air flow during measurement	0,5m/s
	Storage temperature range	-40 °C ... +85 °C
	Humidity	10 ... 95% relative humidity, no condensation permitted
	Environment	For UL compliant usage: The device must be used in a pollution degree 2 environment.
Device	Dimensions (L x W x H)	120,0 x 95 x 21,5 mm
	Mounting/Installation	PCI Express x1 slot (3.3 V), refer to section <i>Slot for the PC Cards cifX PCI, PCIe and Low Profile PCIe</i> , page 43.
	RoHS	Yes
CE Sign	CE Sign	Yes
	Emission	EN 55011:2009 + A1:2010, CISPR 11:2009, Class A (Radio disturbance characteristics - Limits and methods of measurement)
	Immunity	EN 61000-4-2:2009 (Electrostatic discharge test) EN 61000-4-3:2006 + A1:2008 + A2:2010 (Radiated, radio-frequency, electromagnetic field test) EN 61000-4-4:2004 + A1:2010 (Burst Electrical fast transients/burst test) EN 61000-4-5:2006 (Surge test) EN 61000-4-6:2009 (to conducted disturbances, induced by radio- frequency fields) EN 61000-4-8:2010 (power frequency magnetic field test) EN 61000-6-2:2005 + B1:2011 (for industrial environments)

CIFX 50E-2DN	Parameter	Value
Configuration	Configuration Software Master and Slave	SYCON.net
	Configuration Software Slave	netX Configuration Tool

Table 129: Technical Data CIFX 50E-2DN

### 10.1.24 CIFX 50-2ASM

CIFX 50-2ASM	Parameter	Value
Part	Name	CIFX 50-2ASM
	Part No.	1252.630
	Description	PC Card cifX PCI 2 channel AS-Interface Master
	Function	Communication interface with PCI and 2 x AS-Interface interface
Communication Controller	Type	netX 100 processor
Integrated Memory	RAM	8 MB SDRAM
	FLASH	4 MB serial Flash EPROM
	Size of the Dual-Port Memory	64 KByte
System Interface	Bus Type	PCI, according to [bus spec 1], refer to section <i>Overview</i> , page 145.
	Transmission Rate	33 MHz
	Data Access	DPM or DMA (Direct Memory Access)
	Width for the data access to the Dual-Port Memory (DPM)	32-Bit
AS-Interface Communication	Supported communication standard/ protocol (determined by the loaded firmware)	AS-Interface Master
AS-Interface Interface	Transmission rate	166,67 kBit/s
	Interface Type	2 *, acc. to IEC 364-4-41, refer to section <i>AS-Interface Interface</i> , page 139.
	Galvanic Isolation	optically isolated
	Isolation Voltage	1000 VDC (tested for 1 minute)
	Connector	CombiCon male Connector, 2 pin
Display	LED Display	<b>SYS</b> System Status LED <b>COM1</b> LED channel X1 (duo LED) <b>COM2</b> LED channel X2 (duo LED) Refer to chapter <i>LED Descriptions</i> , page 102.
Power supply	Supply Voltage	+3.3 V dc ±5 %, refer to section <i>Power Supply and Host Interface</i> , page 44.
	Current consumption at 3.3 V	700 mA (maximum)
	Connector	Via PCI Bus
Operation	Rotary Switch Slot Number (Card ID)	To set the Slot Number (Card ID)
Environmental Conditions	Operating temperature range*	-20 °C ... +55 °C
	*Air flow during measurement	0,5m/s
	Storage temperature range	-40 °C ... +85 °C
	Humidity	10 ... 95% relative humidity, no condensation permitted
	Environment	For UL compliant usage: The device must be used in a pollution degree 2 environment.

CIFX 50-2ASM	Parameter	Value
Device	Dimensions (L x W x H)	120 x 94,5 x 18,5 mm
	Mounting/Installation	PCI slot (3.3 V), refer to section <i>Slot for the PC Cards cifX PCI, PCIe and Low Profile PCIe</i> , page 43.
	RoHS	Yes
CE Sign	CE Sign	Yes
	Emission	EN 55011:2009 + A1:2010, CISPR 11:2009, Class A (Radio disturbance characteristics - Limits and methods of measurement)
	Immunity	EN 61000-4-2:2009 (Electrostatic discharge test) EN 61000-4-3:2006 + A1:2008 + A2:2010 (Radiated, radio-frequency, electromagnetic field test) EN 61000-4-4:2004 + A1:2010 (Burst Electrical fast transients/burst test) EN 61000-4-5:2006 (Surge test) EN 61000-4-6:2009 (to conducted disturbances, induced by radio- frequency fields) EN 61000-4-8:2010 (power frequency magnetic field test) EN 61000-6-2:2005 + B1:2011 (for industrial environments)
UL Certification	The device CIFX 50-2ASM is certified according to UL 508.	UL-File-Nr. E221530
Configuration	Configuration Software	SYCON.net

Table 130: Technical Data CIFX 50-2ASM

### 10.1.25 CIFX 50E-2ASM

CIFX 50E-2ASM	Parameter	Value
Part	Name	CIFX 50E-2ASM
	Part No.	1253.630
	Description	PC Card cifX PCI Express2 channel AS-Interface Master
	Function	Communication interface with PCI Express and 2 x AS-Interface interface
Communication Controller	Type	netX 500 processor (since hardware revision 04 netX 500; before netX 100)
Integrated Memory	RAM	8 MB SDRAM
	FLASH	4 MB serial Flash EPROM
	Size of the Dual-Port Memory	64 KByte
System Interface	Bus Type	PCI Express, One Lane Port, according to [bus spec 2, Rev. 2.0] and [bus spec 3], refer to section <i>Overview</i> , page 145.
	Transmission Rate	2 GBit/s
	Data Access	DPM or DMA* (Direct Memory Access); *beginning from Hardware Revision 4
	Width for the data access to the Dual-Port Memory (DPM)	32-Bit
AS-Interface Communication	Supported communication standard/ protocol (determined by the loaded firmware)	AS-Interface Master
AS-Interface Interface	Transmission rate	166,67 kBit/s
	Interface Type	2 *, acc. to IEC 364-4-41, refer to section <i>AS-Interface Interface</i> , page 139.
	Galvanic Isolation	optically isolated



CIFX 50E-2ASM	Parameter	Value
	Isolation Voltage	1000 VDC (tested for 1 minute)
	Connector	CombiCon male Connector, 2 pin
Display	LED Display	<b>SYS</b> System Status LED <b>COM1</b> LED channel X1 (duo LED) <b>COM2</b> LED channel X2 (duo LED) Refer to ch. <i>LED Descriptions</i> , p. 102.
Power supply	Supply Voltage	+3.3 V dc $\pm 5\%$ , refer to section <i>Power Supply and Host Interface</i> , page 44.
	Current consumption at 3.3 V	800 mA (maximum)
	Connector	Via PCI Express Bus
Operation	Rotary Switch Slot Number (Card ID)	To set the Slot Number (Card ID)
Environmental Conditions	Operating temperature range*	0 °C ... +55 °C
	*Air flow during measurement	0,5m/s
	Storage temperature range	-40 °C ... +85 °C
	Humidity	10 ... 95% relative humidity, no condensation permitted
	Environment	For UL compliant usage: The device must be used in a pollution degree 2 environment.
Device	Dimensions (L x W x H)	120 x 94,5 x 18,5 mm
	Mounting/Installation	PCI Express x1 slot (3.3 V), refer to section <i>Slot for the PC Cards cifX PCI, PCIe and Low Profile PCIe</i> , page 43.
	RoHS	Yes
CE Sign	CE Sign	Yes
	Emission	EN 55011:2009 + A1:2010, CISPR 11:2009, Class A (Radio disturbance characteristics - Limits and methods of measurement)
	Immunity	EN 61000-4-2:2009 (Electrostatic discharge test) EN 61000-4-3:2006 + A1:2008 + A2:2010 (Radiated, radio-frequency, electromagnetic field test) EN 61000-4-4:2004 + A1:2010 (Burst Electrical fast transients/burst test) EN 61000-4-5:2006 (Surge test) EN 61000-4-6:2009 (to conducted disturbances, induced by radio- frequency fields) EN 61000-4-8:2010 (power frequency magnetic field test) EN 61000-6-2:2005 + B1:2011 (for industrial environments)
UL Certification	The device CIFX 50E-2ASM is certified according to UL 508.	UL-File-Nr. E221530
Configuration	Configuration Software	SYCON.net

Table 131: Technical Data CIFX 50E-2ASM

### 10.1.26 CIFX 70E-RE, CIFX 70E-REMR

CIFX 70E-RE, CIFX 70E-REMR	Parameter	Value
Part	Name	CIFX 70E-RE      CIFX 70E-REMR
	Part No.	1.259.100      1.259.103
	Description	PC Card cifX Low Profile PCI Express Real-Time-Ethernet Master or Slave (Low Profile PCIe with RTE), (and

CIFX 70E-RE, CIFX 70E-RE\MR	Parameter	Value
		variants with additional MRAM ,MR')
	Function	Communication interface with PCI Express and Ethernet interface
Communication Controller	Type	netX 100 processor
Integrated Memory	RAM	8 MB SDRAM
	FLASH	4 MB serial Flash EPROM
	Size of the Dual-Port Memory	64 KByte
	MRAM (only CIFX 70E-RE\MR)	128Kbyte (= 64K Words); <b>Note:</b> Using the cifX Device Driver (from Version 1.1.1.0) access to this memory is possible and it can be used as a remanent memory.
System Interface	Bus Type	PCI Express, One Lane Port, according to [bus spec 2, Rev. 2.0] and [bus spec 3], refer to section <i>Overview</i> , page 145.
	Transmission Rate	2 GBit/s
	Data Access	DPM or DMA (Direct Memory Access)
	Width for the data access to the Dual-Port Memory (DPM)	32-Bit
Ethernet Communication	Supported Real-Time Ethernet communication systems (determined by the loaded firmware)	CC-Link IE Field Basic Slave
		EtherCAT Master, EtherCAT Slave
		EtherNet/IP Scanner (Master), EtherNet/IP Adapter (Slave),
		Open Modbus/TCP
		POWERLINK Controlled Node/Slave
		PROFINET IO-Controller (Master), PROFINET IO-Device (Slave)
		Sercos Master, Sercos Slave
	VARAN Client (Slave)	
Ethernet Frame Types	Ethernet II	
Ethernet Interface	Transmission rate	100 MBit/s, 10 MBit/s (depending on loaded firmware)
	Interface Type	100 BASE-TX, 10 BASE-T (depending on loaded firmware), refer to section <i>Ethernet Interface</i> , page 135.
	Galvanic Isolation	isolated
	Isolation Voltage	1000 VDC (tested for 1 minute)
	Half duplex/Full duplex	depending on loaded firmware, supported (at 100 MBit/s)
	Auto-Negotiation	depending on loaded firmware
	Auto-Crossover	depending on loaded firmware
	Connector	2* RJ45 Socket
Channel 0 and 1	With loaded EtherCAT Master firmware only the RJ45 channel 0 can be used, channel 1 is deactivated. Beginning with the EtherCAT Master firmware version 3 channel 1 can be reactivated if redundancy is activated. For Open Modbus/TCP with V2.3.4.0 and higher both RJ45 channels can be used.	
Display	LED Display	<b>SYS</b> System Status LED
		The meaning of the following LEDs depends on the loaded firmware: <b>COM 0</b> LED Communication Status 0 (duo LED)

CIFX 70E-RE, CIFX 70E-RE\MR	Parameter	Value
		<b>COM 1</b> LED Communication Status 1 (duo LED) <b>LED yellow</b> at RJ45Ch0 and RJ45Ch1, <b>LED green</b> for Ethernet Link status, Ethernet Activity status and additional status Refer to chapter <i>LED Descriptions</i> , page 102.
Power supply	Supply Voltage	+3.3 V dc $\pm 5\%$ , refer to section <i>Power Supply and Host Interface</i> , page 44.
	Current consumption at 3.3 V	800 mA (maximum)
	Connector	Via PCI Express Bus
Operation	Rotary Switch Slot Number (Card ID)	To set the Slot Number (Card ID)
Environmental Conditions	Operating temperature range*	0 °C ... +65 °C
	*Air flow during measurment	0,5m/s
	Storage temperature range	-40 °C ... +85 °C
	Humidity	10 ... 95% relative humidity, no condensation permitted
Device	Dimensions (L x W x H)	119,0 x 69,0 x 18,5 mm
	Mounting/Installation	PCI Express x4 slot (3.3 V), refer to section <i>Slot for the PC Cards cifX PCI, PCIe and Low Profile PCIe</i> , page 43.
	RoHS	Yes
CE Sign	CE Sign	Yes
	Emission	EN 55011:2009 + A1:2010, CISPR 11:2009, Class A (Radio disturbance characteristics - Limits and methods of measurement)
	Immunity	EN 61000-4-2:2009 (Electrostatic discharge test) EN 61000-4-3:2006 + A1:2008 + A2:2010 (Radiated, radio-frequency, electromagnetic field test) EN 61000-4-4:2004 + A1:2010 (Burst Electrical fast transients/burst test) EN 61000-4-5:2006 (Surge test) EN 61000-4-6:2009 (to conducted disturbances, induced by radio- frequency fields) EN 61000-4-8:2010 (power frequency magnetic field test) EN 61000-6-2:2005 + B1:2011 (for industrial environments)
Configuration	Configuration Software Master and Slave	SYCON.net
	Configuration Software Slave	netX Configuration Tool

Table 132: Technical Data CIFX 70E-RE, CIFX 70E-RE\MR

### 10.1.27 CIFX 100EH-RE\CUBE

CIFX 100EH-RE	Parameter	Value
Part	Name	CIFX 100EH-RE
	Part No.	9016.090
	Description	PC Card cifX PCI Express for Real-Time Ethernet Master or Slave, (low-profile card) exclusively for the installing in KEBA KeControl industry PCs series CP 3XX (Cube).
	Function	Communication interface with PCI Express and Ethernet interface
Communication Controller	Type	netX 100 processor
Integrated Memory	RAM	8 MB SDRAM
	FLASH	4 MB serial Flash EPROM
	Size of the Dual-Port Memory	64 KByte
System Interface	Bus Type	PCI Express, One Lane Port*, (refer to section <i>Overview</i> , page 145 and <i>Pin Assignment for PCI Express Bus CIFX 100EH-RE\CUBE</i> , page 146.  *The PC card CIFX 100EH-RE\CUBE can be used for x4 connectors, but not a real x4 connection (mechanical deviation from the standard, it is used only 1 lane).
	Transmission Rate	2 GBit/s
	Data Access	DPM or DMA (Direct Memory Access)
	Width for the data access to the Dual-Port Memory (DPM)	32-Bit
Ethernet Communication	Supported Real-Time Ethernet communication systems (determined by the loaded firmware)	EtherCAT Master, EtherCAT Slave
		EtherNet/IP Scanner (Master), EtherNet/IP Adapter (Slave),
		Open Modbus/TCP
		POWERLINK Controlled Node/Slave
		PROFINET IO-Controller (Master), PROFINET IO-Device (Slave)
		Sercos Master, Sercos Slave
	VARAN Client (Slave)	
Ethernet Frame Types	Ethernet II	
Ethernet Interface	Transmission rate	100 MBit/s, 10 MBit/s (depending on loaded firmware)
	Interface Type	100 BASE-TX, 10 BASE-T (depending on loaded firmware), refer to section <i>Ethernet Interface</i> , page 135.
	Galvanic Isolation	isolated
	Isolation Voltage	1000 VDC (tested for 1 minute)
	Half duplex/Full duplex	depending on loaded firmware, supported (at 100 MBit/s)
	Auto-Negotiation	depending on loaded firmware
	Auto-Crossover	depending on loaded firmware
	Connector	2* RJ45 Socket
Channel 0 and 1	With loaded EtherCAT Master firmware only the RJ45 channel 0 can be used, channel 1 is deactivated. Beginning with the EtherCAT Master firmware version 3 channel 1 can be reactivated if redundancy is activated. For Open Modbus/TCP with V2.3.4.0 and higher both RJ45 channels can be used.	

CIFX 100EH-RE	Parameter	Value
Display	LED Display	<p><b>SYS</b> System Status LED</p> <p>The meaning of the following LEDs depends on the loaded firmware:</p> <p><b>COM 0</b> LED Communication Status 0 (duo LED)</p> <p><b>COM 1</b> LED Communication Status 1 (duo LED)</p> <p><b>LED yellow</b> at RJ45Ch0 and RJ45Ch1, for Ethernet Link status, Ethernet Activity status and additional status</p> <p><b>LED green</b></p> <p>Refer to chapter <i>LED Descriptions</i>, page 102.</p>
Power supply	Supply Voltage	+3.3 V dc $\pm 5\%$ , refer to section <i>Power Supply and Host Interface</i> , page 44.
	Current consumption at 3.3 V	800 mA (maximum)
	Connector	Via PCI Express Bus
Operation	Rotary Switch Slot Number (Card ID)	To set the Slot Number (Card ID)
Environmental Conditions	Operating temperature range*	0 °C ... +65 °C
	*Air flow during measurment	0,5m/s
	Storage temperature range	-40 °C ... +85 °C
	Humidity	10 ... 95% relative humidity, no condensation permitted
	Environment	For UL compliant usage: The device must be used in a pollution degree 2 environment.
Device	Dimensions (L x W x H)	110,0 x 69,0 x 18,5 mm
	Mounting/Installation	PCI Express x4 slot (3.3 V), refer to section <i>Slot for the PC Cards cifX PCI, PCIe and Low Profile PCIe</i> , page 43. x4 <sup>5</sup> = Four Lane; In the PCI Express x4 slot only lane 0 is used. For further details refer to section <i>Pin Assignment for PCI Express Bus CIFX 100EH-RE\CUBE</i> on page 146.
	Master License	NXLIC Master (Part No 8211.000)
	RoHS	Yes
CE Sign	CE Sign	Yes
	Emission	EN 55011:2009 + A1:2010, CISPR 11:2009, Class A (Radio disturbance characteristics - Limits and methods of measurement)
	Immunity	EN 61000-4-2:2009 (Electrostatic discharge test) EN 61000-4-3:2006 + A1:2008 + A2:2010 (Radiated, radio-frequency, electromagnetic field test) EN 61000-4-4:2004 + A1:2010 (Burst Electrical fast transients/burst test) EN 61000-4-5:2006 (Surge test) EN 61000-4-6:2009 (to conducted disturbances, induced by radio- frequency fields) EN 61000-4-8:2010 (power frequency magnetic field test) EN 61000-6-2:2005 + B1:2011 (for industrial environments)
UL Certification	The device CIFX 100EH-RE\CUBE is certified according to UL 508.	UL-File-Nr. E221530

<sup>5</sup> The term "x4" refers to the convention of the PCI Express specifications [bus spec 3] to the number of lanes in the slot.

CIFX 100EH-RE	Parameter	Value
Configuration	Configuration Software Master and Slave	SYCON.net
	Configuration Software Slave	netX Configuration Tool

Table 133: Technical Data CIFX 100EH-RE\CUBE

### 10.1.28 CIFX 70E-DP, CIFX 70E-DP\MR

CIFX 70E-DP, CIFX 70E-DP\MR	Parameter	Value
Part	Name	CIFX 70E-DP                      CIFX 70E-DP\MR
	Part No.	1259.410                              1259.413
	Description	PC Card cifX Low Profile PCI Express PROFIBUS DP Master or Slave and PROFIBUS MPI Device (Low Profile PCIe with PROFIBUS), (and variants with additional MRAM ,MR')
	Function	Communication interface with PCI Express and PROFIBUS interface
Communication Controller	Type	netX 100 processor
Integrated Memory	RAM	8 MB SDRAM
	FLASH	4 MB serial Flash EPROM
	Size of the Dual-Port Memory	64 KByte
	MRAM (only CIFX 70E-DP\MR)	128Kbyte (= 64K Words); <b>Note:</b> Using the cifX Device Driver (from Version 1.1.1.0) access to this memory is possible and it can be used as a remanent memory.
System Interface	Bus Type	PCI Express, One Lane Port, according to [bus spec 2, Rev. 2.0] and [bus spec 3], refer to section <i>Overview</i> , page 145.
	Transmission Rate	2 GBit/s
	Data Access	DPM or DMA (Direct Memory Access)
	Width for the data access to the Dual-Port Memory (DPM)	32-Bit
PROFIBUS Communication	Supported communication standard/ protocol (determined by the loaded firmware)	PROFIBUS DP Master, PROFIBUS DP Slave, PROFIBUS MPI Device
PROFIBUS Interface	Transmission rate	9,6 kBit/s, 19,2 kBit/s, 31,25 kBit/s, 45,45 kBit/s, 93,75 kBit/s, 187,5 kBit/s, 500 kBit/s, 1,5 MBit/s, 3 MBit/s, 6 MBit/s, 12 MBit/s
	Interface Type	RS 485, refer to section <i>PROFIBUS Interface</i> , page 138.
	Galvanic Isolation	isolated
	Isolation Voltage	1000 VDC (tested for 1 minute)
	Connector	DSub female Connector, 9 pin
Display	LED Display	<b>SYS</b> System Status LED <b>COM</b> LED Communication Status (duo LED) The meaning of the COM LED depends on the loaded firmware. Refer to chapter <i>LED Descriptions</i> , page 102.
Power supply	Supply Voltage	+3.3 V dc ±5 %, refer to section <i>Power Supply and Host Interface</i> , page 44.
	Current consumption at 3.3 V	800 mA (maximum)
	Connector	Via PCI Express Bus
Operation	Rotary Switch Slot Number (Card ID)	To set the Slot Number (Card ID)

CIFX 70E-DP, CIFX 70E-DP\MR	Parameter	Value
Environmental Conditions	Operating temperature range*	0 °C ... +65 °C
	*Air flow during measurement	0,5m/s
	Storage temperature range	-40 °C ... +85 °C
	Humidity	10 ... 95% relative humidity, no condensation permitted
Device	Dimensions (L x W x H)	119,0 x 69,0 x 18,5 mm
	Mounting/Installation	PCI Express x1 slot (3.3 V), refer to section <i>Slot for the PC Cards cifX PCI, PCIe and Low Profile PCIe</i> , page 43.
	RoHS	Yes
CE Sign	CE Sign	Yes
	Emission	EN 55011:2009 + A1:2010, CISPR 11:2009, Class A (Radio disturbance characteristics - Limits and methods of measurement)
	Immunity	EN 61000-4-2:2009 (Electrostatic discharge test) EN 61000-4-3:2006 + A1:2008 + A2:2010 (Radiated, radio-frequency, electromagnetic field test) EN 61000-4-4:2004 + A1:2010 (Burst Electrical fast transients/burst test) EN 61000-4-5:2006 (Surge test) EN 61000-4-6:2009 (to conducted disturbances, induced by radio- frequency fields) EN 61000-4-8:2010 (power frequency magnetic field test) EN 61000-6-2:2005 + B1:2011 (for industrial environments)
Configuration	Configuration Software Master and Slave	SYCON.net
	Configuration Software Slave	netX Configuration Tool

Table 134: Technical Data CIFX 70E-DP, CIFX 70E-DP\MR

### 10.1.29 CIFX 70E-CO, CIFX 70E-CO\MR

CIFX 70E-CO, CIFX 70E-CO\MR	Parameter	Value
Part	Name	CIFX 70E-CO                      CIFX 70E-CO\MR
	Part No.	1259.500                              1259.503
	Description	PC-Karte cifX Low Profile PCI Express CANopen Master or Slave (Low Profile PCIe mit CANopen), (and variants with additional MRAM ,MR')
	Function	Communication interface with PCI Express and CANopen interface
Communication Controller	Type	netX 100 processor
Integrated Memory	RAM	8 MB SDRAM
	FLASH	4 MB serial Flash EPROM
	Size of the Dual-Port Memory	64 KByte
	MRAM (only CIFX 70E-CO\MR)	128Kbyte (= 64K Words); <b>Note:</b> Using the cifX Device Driver (from Version 1.1.1.0) access to this memory is possible and it can be used as a remanent memory.
System Interface	Bus Type	PCI Express, One Lane Port, according to [bus spec 2, Rev. 2.0] and [bus spec 3], refer to section <i>Overview</i> , page 145.
	Transmission Rate	2 GBit/s

CIFX 70E-CO, CIFX 70E-CO\MR	Parameter	Value
	Data Access	DPM or DMA (Direct Memory Access)
	Width for the data access to the Dual-Port Memory (DPM)	32-Bit
CANopen Communication	Supported communication standard/ protocol (determined by the loaded firmware)	CANopen Master, CANopen Slave
CANopen Interface	Transmission rate	10 kBit/s, 20 kBit/s, 50 kBit/s, 100 kBit/s, 125 kBit/s, 250 kBit/s, 500 kBit/s, 800 kBit/s, 1 MBit/s
	Interface Type	ISO-11898, refer to section <i>CANopen Interface</i> , page 138.
	Galvanic Isolation	optically isolated
	Isolation Voltage	1000 VDC (tested for 1 minute)
	Connector	DSub male Connector, 9 pin
Display	LED Display	<b>SYS</b> System Status LED <b>CAN</b> CANopen Status (duo LED)
		The meaning of the CAN LED depends on the loaded firmware. Refer to chapter <i>LED Descriptions</i> , page 102.
Power supply	Supply Voltage	+3.3 V dc ±5 %, refer to section <i>Power Supply and Host Interface</i> , page 44.
	Current consumption at 3.3 V	800 mA (maximum)
	Connector	Via PCI Express Bus
Operation	Rotary Switch Slot Number (Card ID)	To set the Slot Number (Card ID)
Environmental Conditions	Operating temperature range*	0 °C ... +65 °C
	*Air flow during measurement	0,5m/s
	Storage temperature range	-40 °C ... +85 °C
	Humidity	10 ... 95% relative humidity, no condensation permitted
Device	Dimensions (L x W x H)	119,0 x 69,0 x 18,5 mm
	Mounting/Installation	PCI Express x1 slot (3.3 V), refer to section <i>Slot for the PC Cards cifX PCI, PCIe and Low Profile PCIe</i> , page 43.
	RoHS	Yes
CE Sign	CE Sign	Yes
	Emission	EN 55011:2009 + A1:2010, CISPR 11:2009, Class A (Radio disturbance characteristics - Limits and methods of measurement)
	Immunity	EN 61000-4-2:2009 (Electrostatic discharge test) EN 61000-4-3:2006 + A1:2008 + A2:2010 (Radiated, radio-frequency, electromagnetic field test) EN 61000-4-4:2004 + A1:2010 (Burst Electrical fast transients/burst test) EN 61000-4-5:2006 (Surge test) EN 61000-4-6:2009 (to conducted disturbances, induced by radio- frequency fields) EN 61000-4-8:2010 (power frequency magnetic field test) EN 61000-6-2:2005 + B1:2011 (for industrial environments)
Configuration	Configuration Software Master and Slave	SYCON.net
	Configuration Software Slave	netX Configuration Tool

Table 135: Technical Data CIFX 70E-CO, CIFX 70E-CO\MR



### 10.1.30 CIFX 70E-DN, CIFX 70E-DN\MR

CIFX 70E-DN, CIFX 70E-DN\MR	Parameter	Value	
Part	Name	CIFX 70E-DN	CIFX 70E-DN\MR
	Part No.	1259.510	1259.513
	Description	PC Card cifX Low Profile PCI Express DeviceNet Master or Slave (Low Profile PCIe with DeviceNet), (and variants with additional MRAM ,MR')	
	Function	Communication interface with PCI Express and DeviceNet interface	
Communication Controller	Type	netX 100 processor	
Integrated Memory	RAM	8 MB SDRAM	
	FLASH	4 MB serial Flash EPROM	
	Size of the Dual-Port Memory	64 KByte	
	MRAM (only CIFX 70E-DN\MR)	128Kbyte (= 64K Words); <b>Note:</b> Using the cifX Device Driver (from Version 1.1.1.0) access to this memory is possible and it can be used as a remanent memory.	
System Interface	Bus Type	PCI Express, One Lane Port, according to [bus spec 2, Rev. 2.0] and [bus spec 3], refer to section <i>Overview</i> , page 145.	
	Transmission Rate	2 GBit/s	
	Data Access	DPM or DMA (Direct Memory Access)	
	Width for the data access to the Dual-Port Memory (DPM)	32-Bit	
DeviceNet Communication	Supported communication standard/ protocol (determined by the loaded firmware)	DeviceNet Master, DeviceNet Slave	
DeviceNet Interface	Transmission rate	125 kBit/s, 250 kBit/s, 500 kBit/s	
	Interface Type	ISO-11898 according to DeviceNet specification, refer to section <i>DeviceNet Interface</i> , page 139.	
	Galvanic Isolation	optically isolated	
	Isolation Voltage	1000 VDC (tested for 1 minute)	
	Connector	CombiCon male Connector, 5 pin	
Display	LED Display	<b>SYS</b> System Status LED <b>MNS</b> Module Network Status (duo LED) The meaning of the MNS LED depends on the loaded firmware. Refer to chapter <i>LED Descriptions</i> , page 102.	
Power supply	Supply Voltage	+3.3 V dc $\pm 5\%$ , refer to section <i>Power Supply and Host Interface</i> , page 44.	
	Current consumption at 3.3 V	800 mA (maximum)	
	Connector	Via PCI Express Bus	
Operation	Rotary Switch Slot Number (Card ID)	To set the Slot Number (Card ID)	
Environmental Conditions	Operating temperature range*	0 °C ... +65 °C	
	*Air flow during measurment	0,5m/s	
	Storage temperature range	-40 °C ... +85 °C	
	Humidity	10 ... 95% relative humidity, no condensation permitted	
Device	Dimensions (L x W x H)	119,0 x 69,0 x 18,5 mm	
	Mounting/Installation	PCI Express x1 slot (3.3 V), refer to section <i>Slot for the PC Cards cifX PCI, PCIe and Low Profile PCIe</i> , page 43.	

CIFX 70E-DN, CIFX 70E-DNMR	Parameter	Value
	RoHS	Yes
CE Sign	CE Sign	Yes
	Emission	EN 55011:2009 + A1:2010, CISPR 11:2009, Class A (Radio disturbance characteristics - Limits and methods of measurement)
	Immunity	EN 61000-4-2:2009 (Electrostatic discharge test) EN 61000-4-3:2006 + A1:2008 + A2:2010 (Radiated, radio-frequency, electromagnetic field test) EN 61000-4-4:2004 + A1:2010 (Burst Electrical fast transients/burst test) EN 61000-4-5:2006 (Surge test) EN 61000-4-6:2009 (to conducted disturbances, induced by radio- frequency fields) EN 61000-4-8:2010 (power frequency magnetic field test) EN 61000-6-2:2005 + B1:2011 (for industrial environments)
Configuration	Configuration Software Master and Slave	SYCON.net
	Configuration Software Slave	netX Configuration Tool

Table 136: Technical Data CIFX 70E-DN, CIFX 70E-DNMR

## 10.2 PCI IDs PC Cards cifX on the PCI Bus

On the PCI bus the PC Cards cifX have the following PCI IDs:

PCI IDs	Value
VendorID	0x15CF
DeviceID	0x0000
Subsystem Vendor ID	0x0000
Subsystem Device ID	0x0000

Table 137: PCI IDs PC Cards cifX on the PCI Bus

## 10.3 Supported PCI-Bus Commands

From the following table you can see which PCI bus commands are supported by the Hilscher PC Cards cifX *PCI*, *PCI Express* and *Low Profile PCI Express*.

C/BE3#	C/BE2#	C/BE1#	C/BE0#	Command Type	supported
0	0	0	0	Interrupt Acknowledge	no
0	0	0	1	Special Cycle	no
0	0	1	0	I/O Read	✓
0	0	1	1	I/O Write	✓
0	1	0	0	Reserved	no
0	1	0	1	Reserved	no
0	1	1	0	Memory Read	✓
0	1	1	1	Memory Write	✓
1	0	0	0	Reserved	no
1	0	0	1	Reserved	no
1	0	1	0	Configuration Read	✓
1	0	1	1	Configuration Write	✓
1	1	0	0	Memory Read Multiple	no
1	1	0	1	Dual Address Cycle	no
1	1	1	0	Memory Read Line	no
1	1	1	1	Memory Write and Invalidate	no

Table 138: Supported / not supported PCI Bus Commands

**C/BE** = Bus Command and Byte Enable Signal of PCI

## 10.4 Technical Data of the Communication Protocols

### 10.4.1 CC-Link IE Field Basic Slave

Parameter	Description
Maximum number of cyclic input data	RY data: 128 bytes (1024 bits) RWw data: 512 words (16 bit)
Maximum number of cyclic output data	RX data: 128 bytes (1024 bits) RWr data: 512 words (16 bit)
Occupied stations	1 ... 16 (1 station has 64 bits RY data, 32 words RWw data, 64 bits RX data, and 32 words RWr data.)
Acyclic communication	SLMP Server and Client
Data transport layer	Ethernet II, IEEE 802.3
Baud rate	100 MBit/s
Reference to firmware / stack version	V1.1
<b>Ports</b>	
Cyclic data	61450 (UDP)
Discovery and SLMP Server	61451 (UDP)
SLMP Parameter	45237 (UDP)
SLMP Communication	20000 (UDP)

Table 139: Technical data CC-Link IE Field Basic Slave protocol

### 10.4.2 CC-Link IE Field Slave

Parameter	Description
Station types	Remote Device Station, Intelligent Device Station
Remote Device Station	
Maximum number of cyclic input data	RY data: 16 bytes (128 bits) RWw data: 64 words (each 16 bit)
Maximum number of cyclic output data	RX data: 16 bytes (128 bits) RWr data: 64 words (each 16 bit)
Intelligent Device Station	
Maximum number of cyclic input data	RY data: 256 bytes (2048 bits) RWw data: 1024 words (each 16 bit)
Maximum number of cyclic output data	RX data: 256 bytes (2048 bits) RWr data: 1024 words (each 16 bit)
Remote Device Station, Intelligent Device Station	
Acyclic communication	SLMP
Baud rate	1 GBit/s, full-duplex
Data transport layer	Ethernet II, IEEE 802.3
Reference to firmware/stack version	V1.1

Table 140: Technical data CC-Link IE Field Slave protocol

### 10.4.3 EtherCAT Master (V3)

Parameter	Description
Maximum number of EtherCAT slaves	Maximum 200 Slaves. The number of usable slaves depends on the available memory for the configuration file. See 'configuration file' below.
Maximum number of cyclic input data	5760 bytes
Maximum number of cyclic output data	5760 bytes
Minimum bus cycle time	250 µs, depending on the used number of slaves and the used number of cyclic input data and output data. Recommended is a cycle time of 1 ms and higher.
Acyclic communication	CoE (CANopen over EtherCAT) CoE-Upload, CoE-Download Maximum 1500 bytes
Functions	Get OD List Get object description Get entry description Emergency Slave diagnostics
Bus Scan	Supported
Redundancy	Supported, but not at the same time with Distributed Clocks
Distributed Clocks	Supported, but not at the same time with Redundancy
Topology	Line or ring
Baud rate	100 MBit/s
Data transport layer	Ethernet II, IEEE 802.3
Configuration File (ethercat.xml or config.nxd)	PC cards PCI, PCI Express, PCI Express Low Profile, Mini PCI, Compact PCI, Mini PCI Express, PCI-104 Real-Time Ethernet: Maximum 1 MByte PC cards PC/104 Real-Time Ethernet: Maximum 2 MByte
Limitations	The size of the bus configuration file is limited by the size of the RAM Disk (1 Mbyte) or FLASH disk (2 Mbyte). All CoE Uploads, Downloads and information services must fit in one TLR-Packet. Fragmentation is not supported Distubuted Clock and Redundancy can not be used at the same time.
Reference to firmware/stack version	V3.0

Table 141: Technical Data EtherCAT Master Protocol

### 10.4.4 EtherCAT Master (V4)

Parameter	Description
Maximum number of EtherCAT slaves	Maximum of 388 slaves, if RCX_GET_SLAVE_HANDLES_REQ service is used for determining number of slaves. The number of usable slaves depends on several parameters: the available memory for the configuration file (see 'configuration file' below), used cycle time, frame propagation time.
Maximum number of cyclic input data	Appr. 4600 bytes, if no LRW command (Logical Read Write) is used for process data
Maximum number of cyclic output data	Appr. 4600 bytes, if no LRW command (Logical Read Write) is used for process data
Acyclic communication	CoE (CANopen over EtherCAT): SDO, SDOINFO, Emergency FoE (File Access over EtherCAT) SoE (Servo Drive Profile over EtherCAT) EoE (Ethernet over EtherCAT) Configurable with SYCON.net: CoE If the file ETHERCAT.XML contains the appropriate configuration information (e.g. created with "EtherCAT Configurator"), following functions can be used: CoE, SoE, EoE
Mailbox protocols	CoE, EoE, FoE, SoE
Functions	Distributed Clocks Redundancy Slave diagnostics Bus scan
Minimum bus cycle time	250 µs, depending on the used number of slaves and the used number of cyclic input data and output data.
Topology	Line or ring
Slave station address range	1 – 14335
Data transport layer	Ethernet II, IEEE 802.3, 100 MBit/s, full-duplex
Configuration file (ETHERCAT.XML or CONFIG.NXD)	Maximum 1 MByte
Synchronization via ExtSync	Supported (not configurable with SYCON.net)
ENI Slave-to-Slave copy infos	Supported (not configurable with SYCON.net)
Hot Connect	Supported (not configurable with SYCON.net)
EoE (Ethernet over EtherCAT)	Via NDIS
Limitations	The size of the bus configuration file is limited by the size of the RAM disk (1 MByte) or Flash disk (3 MByte). Store-and-forward switches cannot be used within network topology due to hard receive timing model RCX_GET_SLAVE_HANDLES_REQ can only communicate up to 388 slaves. Process data is restricted by the dual-port memory to 5760 bytes.
Reference to firmware / stack version	V4.4

Table 142: Technical Data EtherCAT Master Protocol

### 10.4.5 EtherCAT Slave

Parameter	Description
Maximum number of cyclic input data	256* bytes
Maximum number of cyclic output data	256* bytes
Acyclic communication	SDO SDO Master-Slave SDO Slave-Slave (depending on Master capability)
Type	Complex Slave
Functions	Emergency
FMMUs	3
SYNC Manager	4
Distributed Clocks (DC)	Supported, 32 Bit
Baud rate	100 MBit/s
Data transport layer	Ethernet II, IEEE 802.3
Limitation	LRW is not supported
Reference to firmware/stack version	V2.5 and V4.7

Table 143: Technical Data EtherCAT Slave Protocol



**Note:** \* The loadable firmware supports for the number of cyclic input data and for cyclic output data in total up to 512 bytes. If more than 256 bytes for input data or for output data shall be exchanged via EtherCAT, then a customer specific XML file is necessary. Additionally the following formula applies: The sum of the input data length and the output data length may not exceed 512 bytes, where each length has to be rounded up to the next multiple of 4 for this calculation.

### 10.4.6 EtherNet/IP Scanner (Master)

Parameter	Description
Maximum number of EtherNet/IP connections	64 connections for implicit and explicit
Maximum number of total cyclic input data	5712 bytes
Maximum number of total cyclic output data	5760 bytes
Maximum number of cyclic input data	504 bytes per slave per telegram
Maximum number of cyclic output data	504 bytes per slave per telegram
IO Connection type	Cyclic, minimum 1 ms (depending on used number of connections and used number of input and output data)
Maximum number of unscheduled data	1400 bytes per telegram
UCMM, Class 3	Supported
Explicit Messages, Client and Server Services	Get_Attribute_Single/All Set_Attribute_Single/All
Quick connect	Supported
Predefined standard objects	Identity Object Message Route Object Assembly Object Connection Manager Ethernet Link Object TCP/IP Object DLR Object QoS Object
Maximal number of user specific objects	20
Network scan	Supported
Topology	Tree, Line, Ring
DLR (Device Level Ring)	Beacon based 'Ring Node'
ACD (Address Conflict Detection)	Supported
DHCP	Supported
BOOTP	Supported
Baud rates	10 and 100 MBit/s
Data transport layer	Ethernet II, IEEE 802.3
Switch function	Integrated
Limitations	CIP Sync Services are not implemented TAGs are not supported
Reference to firmware/stack version	V2.10

Table 144: Technical Data EtherNet/IP Scanner Protocol



### 10.4.7 EtherNet/IP Adapter (Slave)

Parameter	Description
Maximum number of input data	504 bytes
Maximum number of output data	504 bytes
IO connection types (implicit)	1 exclusive owner, 1 listen only, 1 input only
IO Connection trigger types	Cyclic, minimum 1 ms* Application Triggered, minimum 1 ms* Change Of State, minimum 1 ms* * depending on number of connections and number of input and output data
Explicit Messages	Connected and unconnected
Maximum number of connections	8, explicit and implicit connections
Unconnected Message Manager (UCMM)	Supported
Quick connect	Supported
Predefined standard objects	Identity Object Message Route Object Assembly Object Connection Manager DLR Object QoS Object TCP/IP Object Ethernet Link Object Time Sync Object
Reset services	Identity Object Reset Service of Type 0 and 1
Maximum number of user specific objects	20
DLR V2 (ring topology)	Supported
ACD (Address Conflict Detection)	Supported
DHCP	Supported
BOOTP	Supported
Baud rates	10 and 100 MBit/s
Duplex modes	Half duplex, Full duplex, Auto negotiation
MDI modes	MDI, MDI-X, Auto-MDIX
Data transport layer	Ethernet II, IEEE 802.3
Switch function	Integrated
Limitations	CIP Sync Services are not implemented TAGs are not supported
Reference to firmware/stack version	V2.13

Table 145: Technical Data EtherNet/IP Adapter Protocol

### 10.4.8 Open Modbus/TCP

Parameter	Description
Maximum number of input data	2880 Registers
Maximum number of output data	2880 Registers
Acyclic communication	Read/Write Register: - Maximum 125 Registers per Read Telegram (FC 3, 4, 23), - Maximum 121 Registers per Write Telegram (FC 23), - Maximum 123 Registers per Write Telegram (FC 16)  Read/Write Coil: - Maximum 2000 Coils per Read Telegram (FC 1, 2), - Maximum 1968 Coils per Write Telegram (FC 15)
Modbus Function Codes	1, 2, 3, 4, 5, 6, 7, 15, 16, 23*, 43  * Function Code 23 can be used via the packet API, but not with the Command Table.
Protocol Mode	Message Mode (Client Mode): - Client (using the Command Table: The data is stored in the I/O process data image) - Client (using the packet API: The I/O process data image is not used) - Server (using the packet API: The I/O process data image is not used)  I/O Mode (Server Mode): - Server (only) (The data is stored in the I/O process data image)
Command table (Configuration API only)	Max. 16 servers configurable Max. 256 commands
Baud rates	10 and 100 MBit/s
Data transport layer	Ethernet II, IEEE 802.3
Reference to firmware/stack version	V2.6

Table 146: Technical Data Open Modbus/TCP Protocol

### 10.4.9 POWERLINK Controlled Node/Slave (V2)

Parameter	Description
Maximum number of cyclic input data	1490 bytes
Maximum number of cyclic output data	1490 bytes
Acyclic data transfer	SDO Upload/Download
Functions	SDO over ASND and UDP
Baud rate	100 MBit/s, half-duplex
Data transport layer	Ethernet II, IEEE 802.3
Ethernet POWERLINK version	V 2
Limitation	No slave to slave communication
Reference to firmware/stack version	V2.1

Table 147: Technical Data POWERLINK Controlled Node Protocol

### 10.4.10 POWERLINK Controlled Node/Slave (V3)

Parameter	Description
Maximum number of cyclic input data	1490 bytes
Maximum number of cyclic output data	1490 bytes
Acyclic data transfer	SDO Upload/Download
Functions	SDO over ASND and UDP
Baud rate	100 MBit/s, half-duplex
Data transport layer	Ethernet II, IEEE 802.3
Ethernet POWERLINK version	V 2
Limitation	No slave to slave communication
Reference to firmware/stack version	V3.4

Table 148: Technical Data POWERLINK Controlled Node Protocol

### 10.4.11 PROFINET IO-Controller (V2)

Parameter	Description
Maximum number of PROFINET IO Devices	128
Maximum number of total cyclic input data	5712 bytes (including IOxS status bytes)
Maximum number of total cyclic output data	5760 bytes (including IOxS status bytes)
Maximum number of cyclic input data	1440 bytes per device (= IOCR data length including IOxS status bytes)
Maximum number of cyclic output data	1440 bytes per device (= IOCR data length including IOxS status bytes)
Acyclic communication	Read/Write Record Limited to 1392 bytes per telegram Limited to 4096 bytes per request
Alarm processing	yes, but requires handling in host application program
Diagnostic data	One 200 byte buffer per IO device
DCP functions via API	Name Assignment IO-Devices (DCP SET NameOfStation) Set IO-Devices IP (DCP SET IP) Signal IO-Device (DCP SET SIGNAL) Reset IO-Device to factory settings (DCP Reset FactorySettings) Bus scan (DCP IDENTIFY ALL)
Supported Protocols	RTC – Real Time Cyclic Protocol, Class 1 RTA – Real Time Acyclic Protocol DCP – Discovery and configuration Protocol CL-RPC – Connectionless Remote Procedure Call
Context management by CL-RPC	Supported
Minimum cycle time	1 ms Different IO-Devices can be configured with different cycle times
Functions	Fast Startup of PROFINET IO Devices supported
Baud rate	100 MBit/s Full-Duplex mode
Data transport layer	Ethernet II, IEEE 802.3
Configuration file	Maximum 1 MByte
Limitations	RT over UDP not supported Multicast communication not supported DHCP is not supported (neither for PROFINET IO-Controller nor for the IO-Devices) Only one IOCR per IO Device NameOfStation of IO Controller CANNOT be set using the DCP SET NameOfStation service but only at start-up while configuring the IO Controller The buffer for IO-Device diagnosis data will be overwritten in case of multiple diagnostic events. Only one (the last) event is stored at the same time. If a single event produces more than 200 bytes of diagnosis data, only the first 200 bytes will be taken care of. The usable (minimum) cycle time depends on the number of used IO Devices, the number of used input and output data. The cycle-time, the number of configured IO Devices and the amount of IO data depend on each other. For example it is not possible due to performance reasons to have 128 IO Devices communication with cycle-time 1ms. The size of the bus configuration file is limited by the size of the RAM Disk (1 MByte) WriteMultiple-Record service is not supported

Parameter	Description
Reference to firmware/stack version	V2.6

Table 149: Technical Data PROFINET IO RT Controller Protocol

### 10.4.12 PROFINET IO-Controller (V3)

Parameter	Description
Maximum number of ARs (Application Relation)	128 for RT communication 64 for IRT communication
Maximum number of cyclic input data	5652 bytes, including provider and consumer status
Maximum number of cyclic output data	5700 bytes, including provider and consumer status
Send clock	1 ms, 2 ms, 4 ms for RT mode 250 µs, 500 µs, 1 ms, 2 ms, 4 ms for IRT mode
Performance limits of ARs	Max. 8 ARs, if a send clock < 500 µs Max. 16 ARs, if a send clock < 1 ms Max. 64 ARs, if a send clock < 2 ms
Maximum number of submodules	2048
Maximum amount of data per IOCR	1440 bytes
Number of IOCRs per AR	1 Input IOCR 1 Output IOCR
Maximum amount of data for acyclic read/write record access	65536 bytes
Maximum amount of record data per AR	16384 bytes
Alarm processing (configurable)	Stack processes alarms automatically Applikation processes alarms
Maximum number of ARVendorBlock	256
Maximum size of ARVendorBlockData	512 bytes
Device Access AR CMI Timeout	20 s
Functions	Automatic Name Assignment Media Redundancy Client Media Redundancy Manager (requires license)
DCP function API	Name Assignment IO-Devices (DCP SET NameOfStation) Set IO-Devices IP (DCP SET IP) Signal IO-Device (DCP SET SIGNAL) Reset IO-Device to factory settings (DCP Reset FactorySettings) Bus scan (DCP IDENTIFY ALL) DCP GET
PROFINET specification	Implemented according to V2.3 ED2 MU3 Legacy Startup supported according to PROFINET specification V2.2

Parameter	Description
Limitations	<p>The size of the bus configuration file is limited by the size of the RAM Disk (1 Mbyte)</p> <p>The usable (minimum) cycle time depends on the number of used IO Devices, the number of used input and output data.</p> <p>RT over UDP not supported</p> <p>Multicast communication not supported</p> <p>DHCP is not supported (neither for PROFINET IO Controller nor for IO-Devices)</p> <p>Only one IOCR per IO-Device per direction</p> <p>One instance of DeviceAccess AR can be used at the same time only</p> <p>MRPD is not supported</p> <p>Planning of IRT is not done by the PROFINET IO Controller protocol stack</p> <p>Sync Slave is not supported</p> <p>One fragmented acyclic services can be used at the same time only</p> <p>Multiple MRP Managers are not supported</p> <p>One DCP Service can be used in parallel only</p> <p>Multiple Sync Masters are not supported</p>
Reference to firmware / stack version	V3.3

Table 150: Technical Data PROFINET IO Controller Protocol

### 10.4.13 PROFINET IO-Device (V3.4)

Parameter	Description
Maximum number of cyclic input data	1024 bytes
Maximum number of cyclic output data	1024 bytes
Acyclic communication	Read/Write Record, max. 1024 bytes per telegram
Alarm Types	Process Alarm, Diagnostic Alarm, Return of SubModule Alarm Plug Alarm (implicit), Pull Alarm (implicit)
Supported protocols	<p>RTC – Real Time Cyclic Protocol, Class 1 and 2 (unsynchronized), Class 3 (synchronized)</p> <p>RTA – Real Time Acyclic Protocol</p> <p>DCP – Discovery and configuration Protocol</p> <p>CL-RPC – Connectionless Remote Procedure Call</p> <p>LLDP – Link Layer Discovery Protocol</p> <p>SNMP – Simple Network Management Protocol</p> <p>MRP – MRP Client</p>
Used Protocols (subset)	UDP, IP, ARP, ICMP (Ping)
Topology recognition	LLDP, SNMP V1, MIB2, physical device
VLAN- and priority tagging	yes
Context Management by CL-RPC	Supported
Identification & Maintenance	Read and write of I&M1-4
Minimum cycle time	<p>1 ms for RTC1 and RTC2</p> <p>250 µs for RTC3</p>
Baud rate	100 MBit/s
Data transport layer	Ethernet II, IEEE 802.3
Limitations	<p>RT over UDP not supported</p> <p>Multicast communication not supported</p> <p>Only one device instance is supported</p>

	<p>DHCP is not supported</p> <p>IRT "flex" (synchronized RT Class 2) is not supported</p> <p>FastStartUp is not supported.</p> <p>Media Redundancy (except MRP client) is not supported</p> <p>Access to the submodule granular status bytes (IOCS) is not supported.</p> <p>The amount of configured IO-data influences the minimum cycle time that can be reached.</p> <p>Supervisor-AR is not supported, Supervisor-DA-AR is supported</p> <p>Only 1 Input-CR and 1 Output-CR are supported</p> <p>Multiple WriteRequests are not supported</p> <p>Using little endian (LSB-MSB) byte order for cyclic process data instead of default big endian (MSB-LSB) byte order may have a negative impact on minimum reachable cycle time</p>
Reference to firmware/stack version	V3.4.x.x

Table 151: Technical Data PROFINET IO RT IRT Device Protocol

### 10.4.14 PROFINET IO Device (V3.13)

Parameter	Description
Maximum number of cyclic input data	1440 bytes
Maximum number of cyclic output data	1440 bytes
Maximum number of submodules	255 submodules per Application Relation at the same time, 1000 submodules can be configured
Multiple Application Relations (AR)	The Stack can handle up to 8 IO-ARs, one Supervisor AR and one Supervisor-DA AR at the same time
Acyclic communication	Read/Write Record, max. 8 KB (fragmented)
Alarm Types	Process Alarm, Diagnostic Alarm, Return of SubModule Alarm, Plug Alarm (implicit), Pull Alarm (implicit), Update Alarm, Status Alarm, Isochronous Problem Alarm, Upload and Retrieval Notification Alarm
Supported protocols	<p>RTC – Real Time Cyclic Protocol, class 1 (unsynchronized), class 3 (synchronized)</p> <p>RTA – Real Time Acyclic Protocol</p> <p>DCP – Discovery and configuration Protocol</p> <p>CL-RPC – Connectionless Remote Procedure Call</p> <p>LLDP – Link Layer Discovery Protocol</p> <p>SNMP – Simple Network Management Protocol</p> <p>MRP – MRP Client</p>
Topology recognition	LLDP, SNMP V1, MIB2, physical device
Identification & Maintenance	Read and write of I&M0-5, Read of I&M5
Minimum cycle time	1 ms for RT_CLASS_1 250 µs for RT_CLASS_3
IRT Support	RT_CLASS_3
Media Redundancy	MRP client is supported
Asset Management	Max. 199 assets
PROFInergy	PROFInergy ASE implementation with one PE entity per submodule
Additional features	DCP, VLAN- and priority tagging, Shared Device (max. 1 RTC3 AR)
Baud rate	100 MBit/s
Data transport layer	Ethernet II, IEEE 802.3
PROFINET IO specification	V2.2 (legacy startup) and V2.3
Limitations	RT over UDP not supported.

	<p>Multicast communication not supported.</p> <p>Only one device instance is supported.</p> <p>DHCP is not supported.</p> <p>FastStartUp is not supported.</p> <p>The amount of configured IO-data influences the minimum cycle time that can be reached.</p> <p>Only 1 Input-CR and 1 Output-CR per AR are supported.</p> <p>Using little endian (LSB-MSB) byte order for cyclic process data instead of default big endian (MSB-LSB) byte order may have a negative impact on minimum reachable cycle time.</p> <p>System Redundancy (SR-AR) and Configuration-in-Run (CiR) are not supported.</p> <p>Max. 255 submodules can be used simultaneously within one specific Application Relation.</p> <p>SharedInput is not supported.</p> <p>MRPD is not supported.</p> <p>DFP and other HighPerformance-profile related features are not supported.</p> <p>PDEV functionality is only supported for submodules located in slot 0.</p> <p>Submodules can not be configured or used by an AR in subslot 0.</p> <p>DAP and PDEV submodules only supported in slot 0.</p> <p>Only one IO Supervisor AR is supported in parallel.</p>
Reference to firmware/stack version	V3.13

Table 152: Technical Data PROFINET IO RT IRT Device Protocol

### 10.4.15 Sercos Master

Parameter	Description
Maximum number of cyclic input data	5760 bytes (including Connection Control per Connection)
Maximum number of cyclic output data	5760 bytes (including Connection Control per Connection)
Maximum number of configured slave devices	511
Minimum cycle time	250 µs
Acyclic communication	Service channel: Read/Write/Commands
Functions	Bus Scan
Communication phases	NRT, CP0, CP1, CP2, CP3, CP4
Topology	Line and double ring
Redundancy	supported
NRT channel	supported
Hot-Plug	supported
Cross Communication	supported, but only if the master is configured by the host application program by packets.
Baud rate	100 MBit/s, full duplex
Data transport layer	Ethernet II, IEEE 802.3
Auto crossover	supported
Supported Sercos version	Communication Specification Version 1.3
TCP/IP stack	integrated
Reference to firmware/stack version	V2.1

Table 153: Technical Data Sercos Master Protocol



### 10.4.16 Sercos Slave

Parameter	Description
Maximum number of cyclic produced data	132 bytes (including Connection Control and IO Status)
Maximum number of cyclic consumed data	124 bytes (including Connection Control and IO Status)
Maximum number of slave devices	8
Sercos addresses	1 ... 511
Minimum cycle time	250 µs
Topology	Line and ring
Communication phases	NRT, CP0, CP1, CP2, CP3, CP4, HP0, HP1, HP2
Descriptors for connections (including Connection Control and IO Status/Control)	Max. 64
Acyclic Communication (Service Channel)	Read/Write/Standard Commands
Cross Communication (CC)	Supported
Baud rate	100 MBit/s
Data transport layer	Ethernet II, IEEE 802.3
Supported Sercos version	Communication Specification Version 1.1.2 and 1.3.1
Supported Sercos Communication Profiles	SCP_FixCFG Version 1.1.1 SCP_VarCFG Version 1.1.1 SCP_VarCFG Version 1.1.3 SCP_HP Version 1.1.1 SCP_SysTime Version 1.3
Supported User SCP Profiles	SCP_WD Version 1.1.1 SCP_Diag Version 1.1.1 SCP_RTb Version 1.1.1 SCP_Mux Version 1.1.1 SCP_Sig 1.1.1 SCP_ExtMuX 1.1.2 SCP_RTbListProd 1.3 SCP_RTbListCons 1.3 SCP_RTbWordProd 1.3 SCP_RTbWordCons 1.3 SCP_OvSBasic 1.3 SCP_WDCon 1.3
Supported FSP profiles	FSP_IO FSP_Drive FSP_Encoder
SCP Sync	Supported
SCP_NRT	Supported
S/IP	Supported
Identification LED	Supported
Storage location of object dictionary	Mixed mode
Limitations	Max. 2 connections: 1 for consumer and 1 for producer Modifications of the Service-Channel Object Dictionary will be volatile after reset (if it resides on device)
Reference to firmware/stack version	V3.5

Table 154: Technical Data Sercos Slave Protocol

### 10.4.17 VARAN Client (Slave)

Parameter	Description
Maximum number of cyclic input data	128 bytes
Maximum number of cyclic output data	128 bytes
Memory Area	Read Memory Area 1, Write Memory Area 1, Read Memory Area 2, Write Memory Area 2
Functions	Memory Read Memory Write
Integrated 2 port splitter for daisy chain topology	Supported
Baud rate	100 MBit/s
Data transport layer	Ethernet II, IEEE 802.3
VARAN protocol version	1.1.1.0
Limitations	Integrated EMAC for IP data exchange with client application not supported SPI single commands (optional feature) not supported
Reference to firmware/stack version	V1.1

Table 155: Technical Data VARAN Client Protocol

### 10.4.18 PROFIBUS DP Master

Parameter	Description
Maximum number of PROFIBUS DP slaves	125 (DPV0/DPV1)
Maximum number of total cyclic input data	5712 bytes
Maximum number of total cyclic output data	5760 bytes
Maximum number of cyclic input data	244 bytes per slave
Maximum number of cyclic output data	244 bytes per slave
Configuration data	Max. 244 bytes per slave
Parameterization data per slave	7 bytes standard parameter per slave Max. 237 bytes application specific parameters per slave
Acyclic communication	DPV1 class 1 read, write DPV1 class 1 alarm DPV1 class 2 initiate, read, write, data transport, abort
Maximum number of acyclic read/write	240 bytes per slave and telegram
Functions	Configuration in Run (CiR), requires host application program support Timestamp (Master functionality)
Redundancy	Supported, requires host application program support
Baud rate	9,6 kBits/s, 19,2 kBits/s, 31,25 kBits/s, 45,45 kBits/s 93,75 kBits/s, 187,5 kBits/s, 500 kBits/s, 1, 5 MBits/s, 3 MBits/s, 6 MBits/s, 12 MBit/s  Auto baud rate detection is not supported
Data transport layer	PROFIBUS FDL
Limitations	DPV2 isochronous mode and slave slave communication are not supported.  The redundancy function can not be used, if the master is configured by the host application program by packets.
Reference to firmware/stack version	V2.8

Table 156: Technical Data PROFIBUS DP Master Protocol

### 10.4.19 PROFIBUS DP Slave

Parameter	Description
Maximum number of cyclic input data	244 bytes
Maximum number of cyclic output data	244 bytes
Maximum number of acyclic data (read/write)	240 bytes/telegram
Maximum number of modules	24
Configuration data	Max. 244 bytes
Parameter data	237 bytes application specific parameters
Acyclic communication	DP V1 Class 1 Read/Write DP V1 Class 1 Alarm DP V1 Class 2 Read/Write/Data Transport
Baud rate	9,6 kBits/s, 19,2 kBits/s, 31,25 kBits/s, 45,45 kBits/s, 93,75 kBits/s, 187,5 kBits/s, 500 kBits/s, 1, 5 MBits/s, 3 MBits/s, 6 MBits/s, 12 MBit/s Auto baudrate detection is supported
Data transport layer	PROFIBUS FDL
Limitations	SSCY1S – Slave to slave communication state machine not implemented Data exchange broadcast not implemented I&M LR services other than Call-REQ/RES are not supported yet
Reference to firmware/stack version	V2.10

Table 157: Technical Data PROFIBUS DP Slave Protocol

### 10.4.20 PROFIBUS MPI

Parameter	Description
Maximum number of MPI connections	126
Maximum number of write data	216 bytes
Maximum number of read data	222 bytes
Functions	MPI Read/Write DB (data block), M (marker), Q (output), C (Counter), T (Timer) MPI Read I (Input) Data type bit to access to DB (data block), M (marker), Q (output) and I (Input, read only) MPI Connect (automatically when first read/write function is used) MPI Disconnect, MPI Disconnect All MPI Get OP Status MPI transparent (expert use only)
Baud rate	Fixed values ranging from 9,6 kBits/s to 12 MBit/s Auto-detection mode is supported
Data transport layer	PROFIBUS FDL
Reference to firmware/stack version	2.4

Table 158: Technical Data PROFIBUS-MPI Protocol

### 10.4.21 CANopen Master

Parameter	Description
Maximum number of CANopen nodes	126
Maximum number of cyclic input data	3584 bytes
Maximum number of cyclic output data	3584 bytes
Maximum number of receive PDOs	512
Maximum number of transmit PDOs	512
Exchange of process data	Via PDO transfer: - synchronized, - remotely requested and - event driven (change of date)
Acyclic communication	SDO Upload/Download, max. 512 bytes per request
Functions	Emergency message (consumer and producer) Node guarding / life guarding, heartbeat PDO mapping NMT Master SYNC protocol (producer) Simple boot-up process, reading object 1000H for identification
Baud rates	10 kBits/s, 20 kBits/s, 50 kBits/s, 100 kBits/s, 125 kBits/s, 250 kBits/s, 500 kBits/s, 800 kBits/s, 1 MBits/s
CAN layer 2 access	Send/receive via API supported (11 bit/29 bit)
Data transport layer	CAN Frames
CAN Frame type for CANopen	11 Bit
Reference to version	V2.14

Table 159: Technical Data CANopen Master Protocol

### 10.4.22 CANopen Slave

Parameter	Description
Maximum number of cyclic input data	512 bytes
Maximum number of cyclic output data	512 bytes
Maximum number of receive PDOs	64
Maximum number of transmit PDOs	64
Exchange of process data	Via PDO transfer - synchronized, - remotely requested and - event driven (change of date, event timer) On request of the host application program by packet
Acyclic communication	SDO upload/download (server only) Emergency message (producer) Timestamp (producer/consumer)
Functions	Node guarding / life guarding Heartbeat: 1 producer, max. 64 consumer PDO mapping NMT Slave SYNC protocol (consumer) Error behaviour (configurable): - in state operational: change to state pre-operational - in any state: no state change - in state operational or pre-operational: change to state stopped
Baud rates	10 kBits/s, 20 kBits/s, 50 kBits/s, 100 kBits/s, 125 kBits/s, 250 kBits/s, 500 kBits/s, 800 kBits/s, 1 MBits/s Auto baudrate detection is supported
CAN layer 2 access	Send/receive via API supported (11 bit/29 bit)
Data transport layer	CAN Frames
CAN Frame type for CANopen	11 Bit
Reference to firmware/stack version	V3.7

Table 160: Technical Data CANopen Slave Protocol

### 10.4.23 DeviceNet Master

Parameter	Description
Maximum number of DeviceNet slaves	63
Maximum number of total cyclic input data	3584 bytes
Maximum number of total cyclic output data	3584 bytes
Maximum number of cyclic input data	255 bytes/connection
Maximum number of cyclic output data	255 bytes/connection
Maximum Configuration data	1000 bytes/slave
Acyclic communication	Explicit connection All service codes are supported
Connections	Bit Strobe Change of State Cyclic Poll Explicit Peer-to-Peer Messaging
Function	Quick Connect
Fragmentation	Explicit and I/O
UCMM	Supported
Objects	Identity Object (Class Code 0x01) Message Router Object (Class Code 0x02) DeviceNet Object (Class Code 0x03) Connection Object (Class Code 0x05) Acknowledge Handler Object (Class Code 0x06)
Baud rates	125 kBits/s, 250 kBit/s, 500 kBit/s  Auto baudrate detection is not supported
Data transport layer	CAN frames
Reference to firmware/stack version	V2.4

Table 161: Technical Data DeviceNet Master Protocol



## 10.4.24 DeviceNet Slave

Parameter	Description
Maximum number of cyclic input data	255 bytes
Maximum number of cyclic output data	255 bytes
Acyclic communication	Get_Attribute_Single/All Max. 240 bytes per request Set_Attribute_Single/All Max. 240 bytes per request
Connections	Poll Change-of-state Cyclic Bit-strobe
Explicit messaging	Supported
Fragmentation	Explicit and I/O
UCMM	Not supported
Baud rates	125 kBits/s, 250 kBit/s, 500 kBit/s  Auto baudrate detection is not supported
Data transport layer	CAN frames
Reference to firmware/stack version	V2.5

Table 162: Technical Data DeviceNet Slave Protocol

### 10.4.25 AS-Interface Master

Parameter	Description
Maximum number of supported slaves	Max. 62 slaves
Maximum number of total cyclic input data	Max. 248 bits using digital slaves Max. 248 bytes using analog (transparent) slaves The maximum number depends on the used slave profiles
Maximum number of total cyclic output data	Max. 248 bits using digital slaves Max. 248 bytes using analog (transparent) slaves The maximum number depends on the used slave profiles
Maximum number of cyclic input data	Max. 4 Bit digital data Max. 4 channel with up to 16 bit analog data The maximum number depends on the used slave profiles
Maximum number of cyclic output data	Max. 4 Bit digital data Max. 4 channel with up to 16 bit analog data The maximum number depends on the used slave profiles
Parameterization data	4 bit per standard slave 3 bit per extended slave
Maximum number of acyclic read/write	Max. 220 bytes for string transfer
Functions	Support of data exchange via combined transaction types 1, 2, 3, 4 and 5 (CTT 1-5) Automatic address assignment Modification of address and Extended ID1-Code of Slave supported Profile for extended Master: M4
Baud rate	166,67 kBaud
AS-Interface specification	3.0 Revision 2
Limitations	'Synchronous Data I/O Mode' not supported
Reference to firmware/stack version	V2.4

Table 163: Technical Data AS-Interface Master Protocol

### 10.4.26 CC Link Slave

Parameter	Description
<b>Firmware works according to CC-Link Version 2.0:</b>	
Station Types	Remote Device Station (up to 4 occupied stations)
Maximum input data	368 bytes
Maximum output data	368 bytes
Input data remote device station	112 bytes (RY) and 256 bytes (RWw)
Output data remote device station	112 bytes (RX) and 256 bytes (RWr)
Extension cycles	1, 2, 4, 8
Baud rates	156 kBit/s, 625 kBit/s, 2500 kBit/s, 5 MBit/s, 10 MBit/s
Limitation	Intelligent Device Station not supported
<b>Firmware works according to CC-Link Version 1.11:</b>	
Station Types	Remote I/O station, Remote device station' (up to 4 occupied stations)
Maximum input data	48 bytes
Maximum output data	48 bytes
Input data remote I/O station	4 bytes (RY)
Output data remote I/O station	4 bytes (RX)
Input data remote device station	4 bytes (RY) and 8 bytes (RWw) per occupied station
Output data remote device station	4 bytes (RX) and 8 bytes (RWr) per occupied station
Baud rates	156 kBit/s, 625 kBit/s, 2500 kBit/s, 5 MBit/s, 10 MBit/s
Firmware	
Reference to firmware/stack version	V2.12

Table 164: Technical Data CC-Link-Slave-Protocol

# 11 Annex

## 11.1 Device Label with Matrix Code

You can identify your device by means of the device label.



**Note:** The position of the device label on your device can be seen from the device drawing.

The device label consists of a matrix code and the information contained therein in plain text.

The 2 D code (Data Matrix Code) contains the following information:

- ① Part number: 1234.567
- ② Hardware revision: 1
- ③ Serial number: 20000 (for mini matrix 20001)

The device label with matrix code can be designed as mini-sticker.

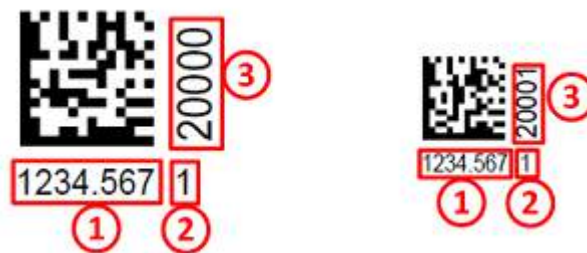

Figure 66: Example 2D Label (mini sticker on the right)

## 11.2 Tolerances of the shown Card Dimensions

The manufacturing tolerance of the printed circuit boards of the PC card cifX is  $\pm 0.1$  mm per milled PCB edge. For all dimensions of the PCB indicated on the drawings (in the sections *Dimensions PC Cards cifX PCI* and *PCI Express* from page 221 and *Dimensions PC Cards cifX Low Profile PCI Express* from page 254) thus results for the length L and the width W, a tolerance of  $\pm 0.1$  mm (per milled edge)  $\times 2 = \pm 0.2$  mm.

$$W = [\text{width of the board in mm}] \pm 0.2 \text{ mm}$$

$$L = [\text{length of the board in mm}] \pm 0.2 \text{ mm}$$

The depth T of the PCB depends on the highest part used or the circuit board plus the descenders. The thickness of the PCB is  $= 1.6 \text{ mm} \pm 10\%$ .



**Note:** The dimensions (L x W x D) specified in section *Technical Data PC Cards cifX* on page 147 (and also the identical values in the data sheet cifX and on the 'Hilscher Site') are rounded and unified for the respective types of card. Here the depth of the PC cards PCI (CIFX 50), PCI Express (CIFX 50E) or Low Profile PCI Express (CIFX 70E) has been equated to the rounded width of the front panel.

# 11.3 Dimensions PC Cards cifX PCI and PCI Express

## 11.3.1 CIFX 50-RE

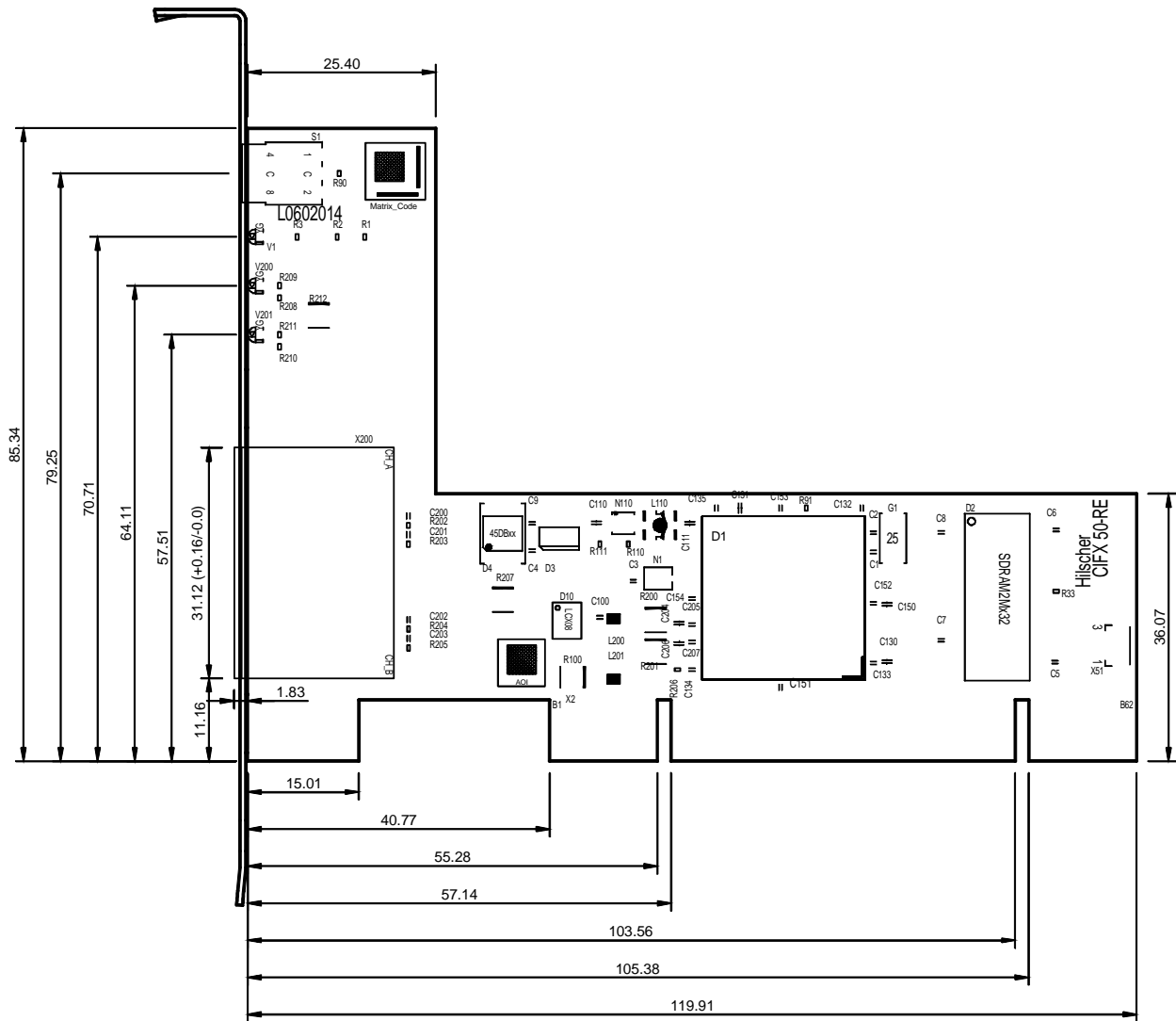



### 11.3.3 Front Panel CIFX 50-RE, CIFX 50E-RE or CIFX 50E-RE/ET

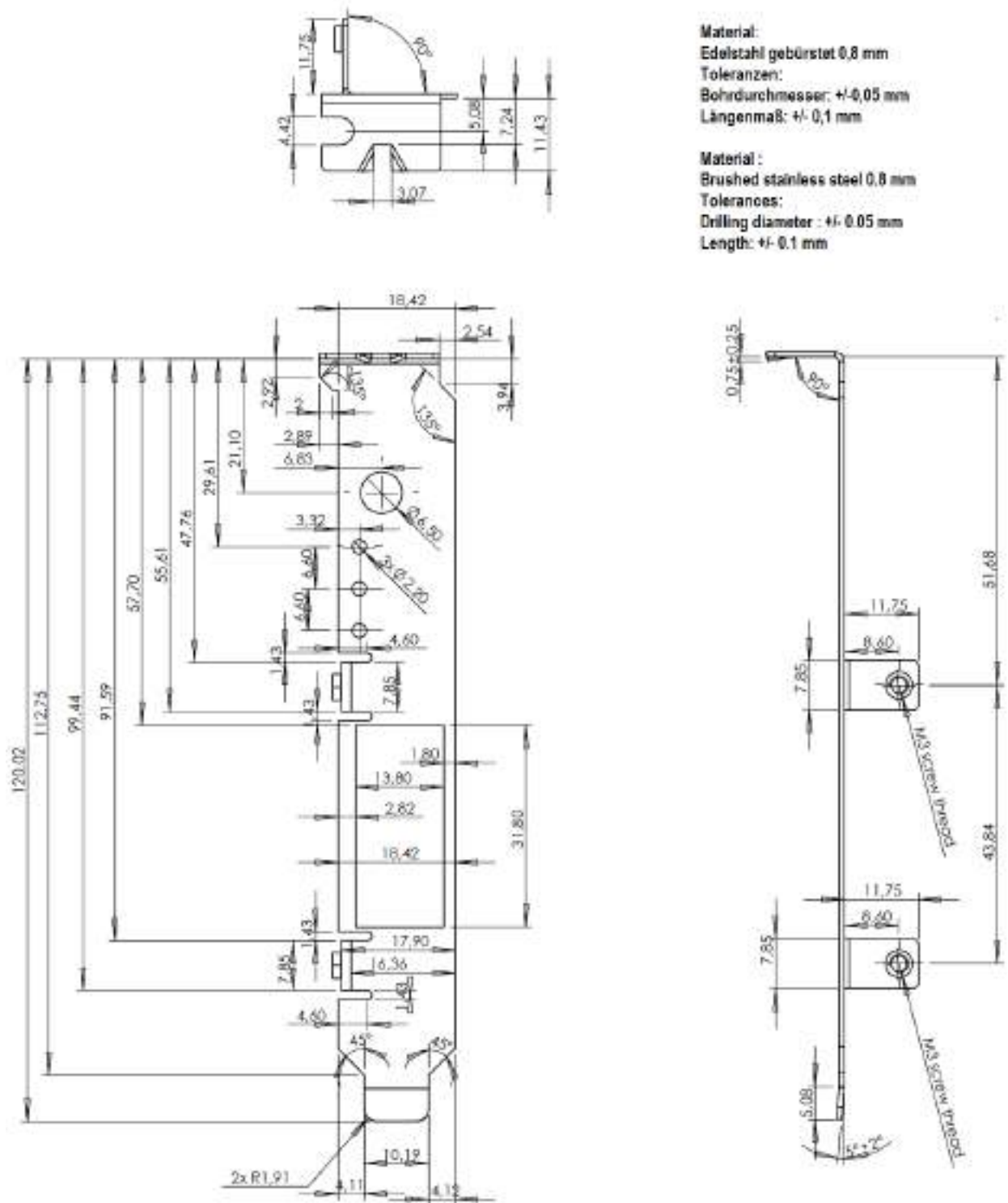

Figure 69: Dimensions Front Panel CIFX 50-RE, CIFX 50E-RE or CIFX 50E-RE/ET

### 11.3.4 CIFX 50E-CCIES

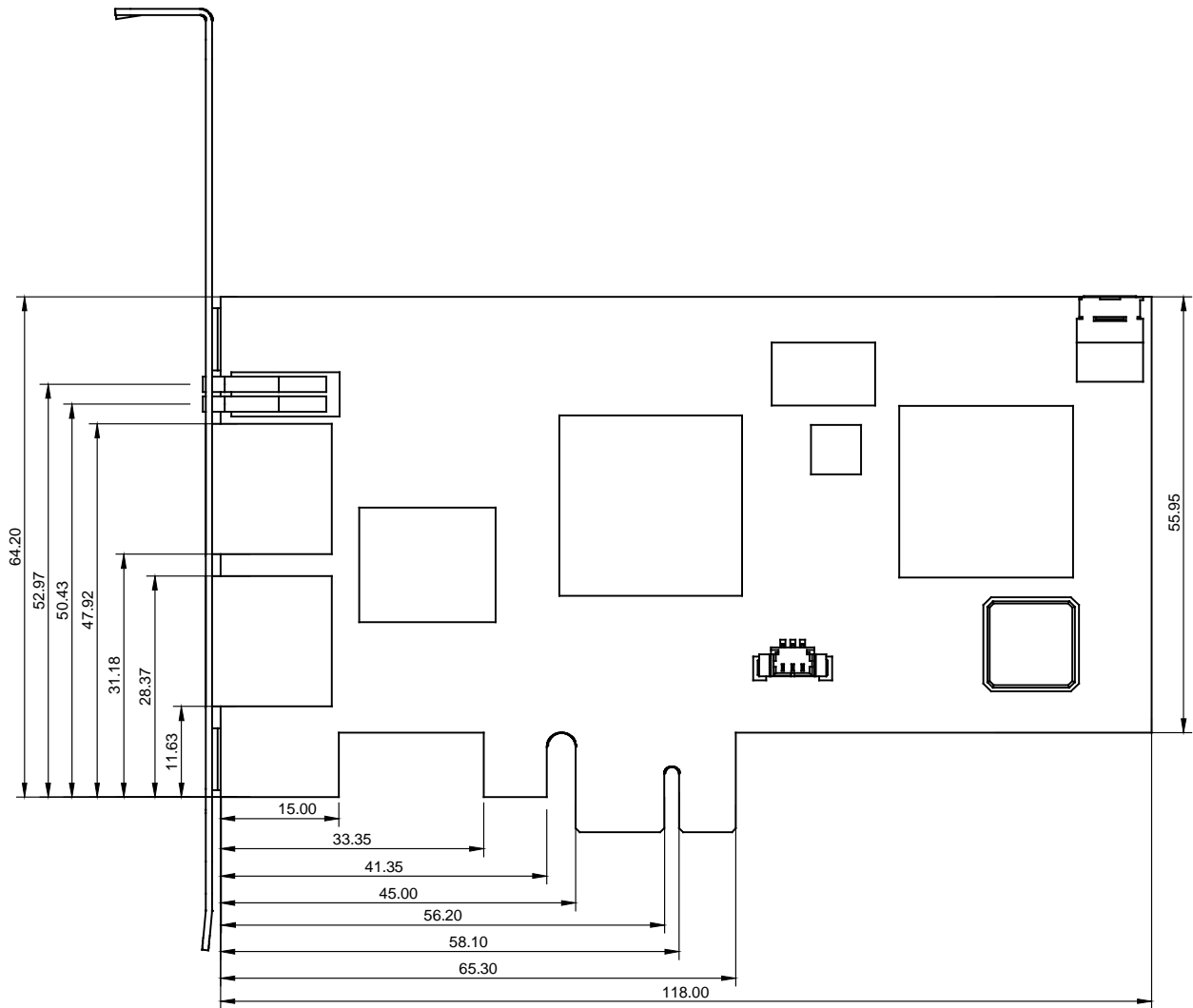
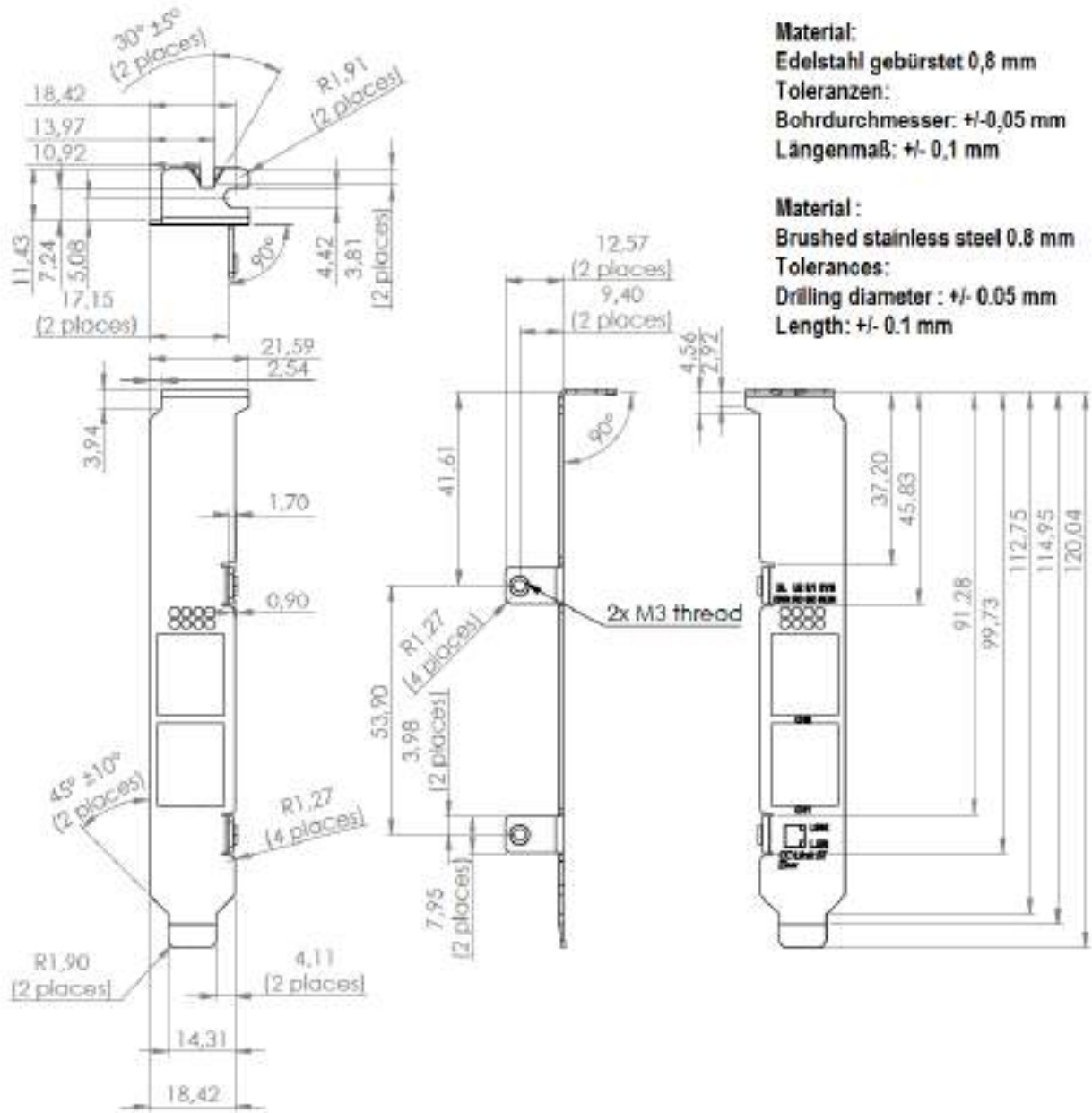

Figure 70: Dimensions CIFX 50E-CCIES (from Hardware Rev.1)



### 11.3.5 Front Panel CIFX 50-CCIES



**Blenden-Ausschnitt    Panel cutout**

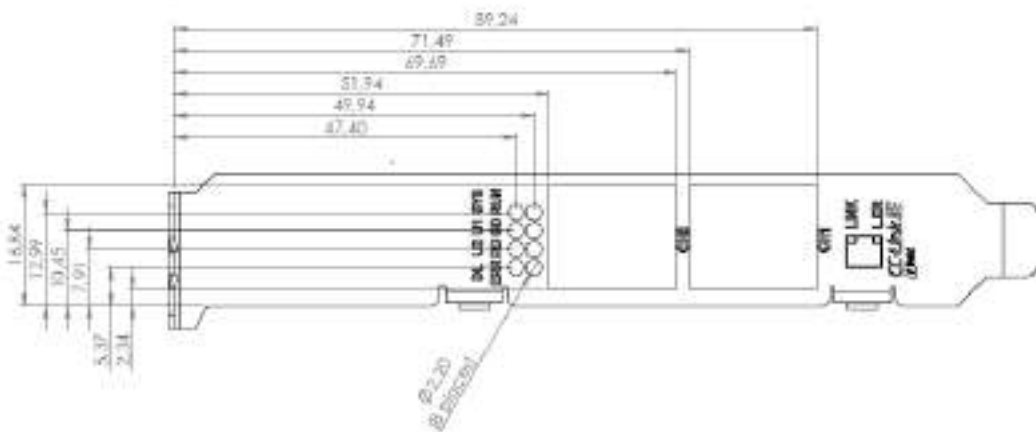

Figure 71: Dimensions Front Panel CIFX 50E-CCIES

### 11.3.6 CIFX 50-DP, CIFX 50E-DP

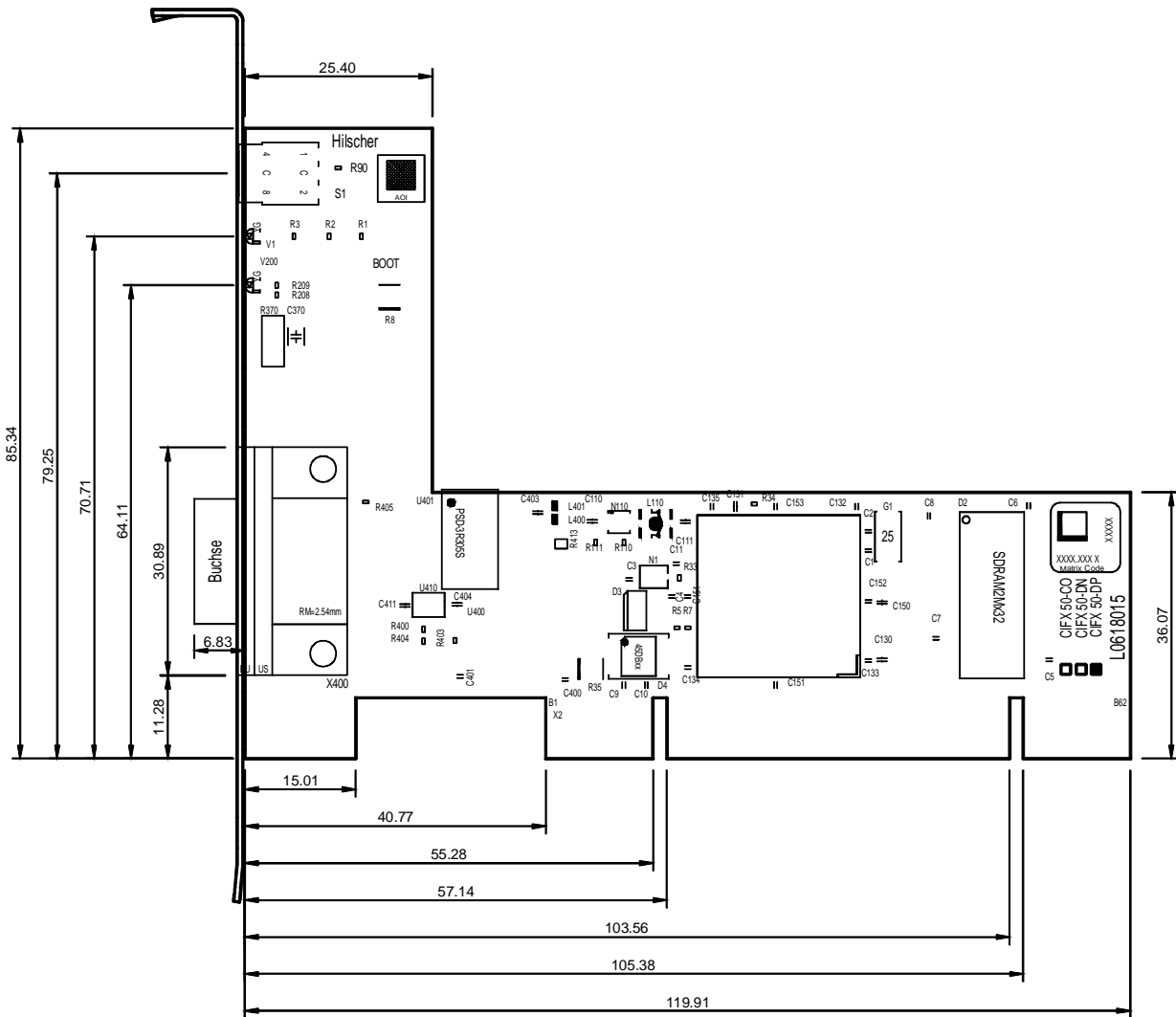

Figure 72: Dimensions CIFX 50-DP (Hardware Rev.5)

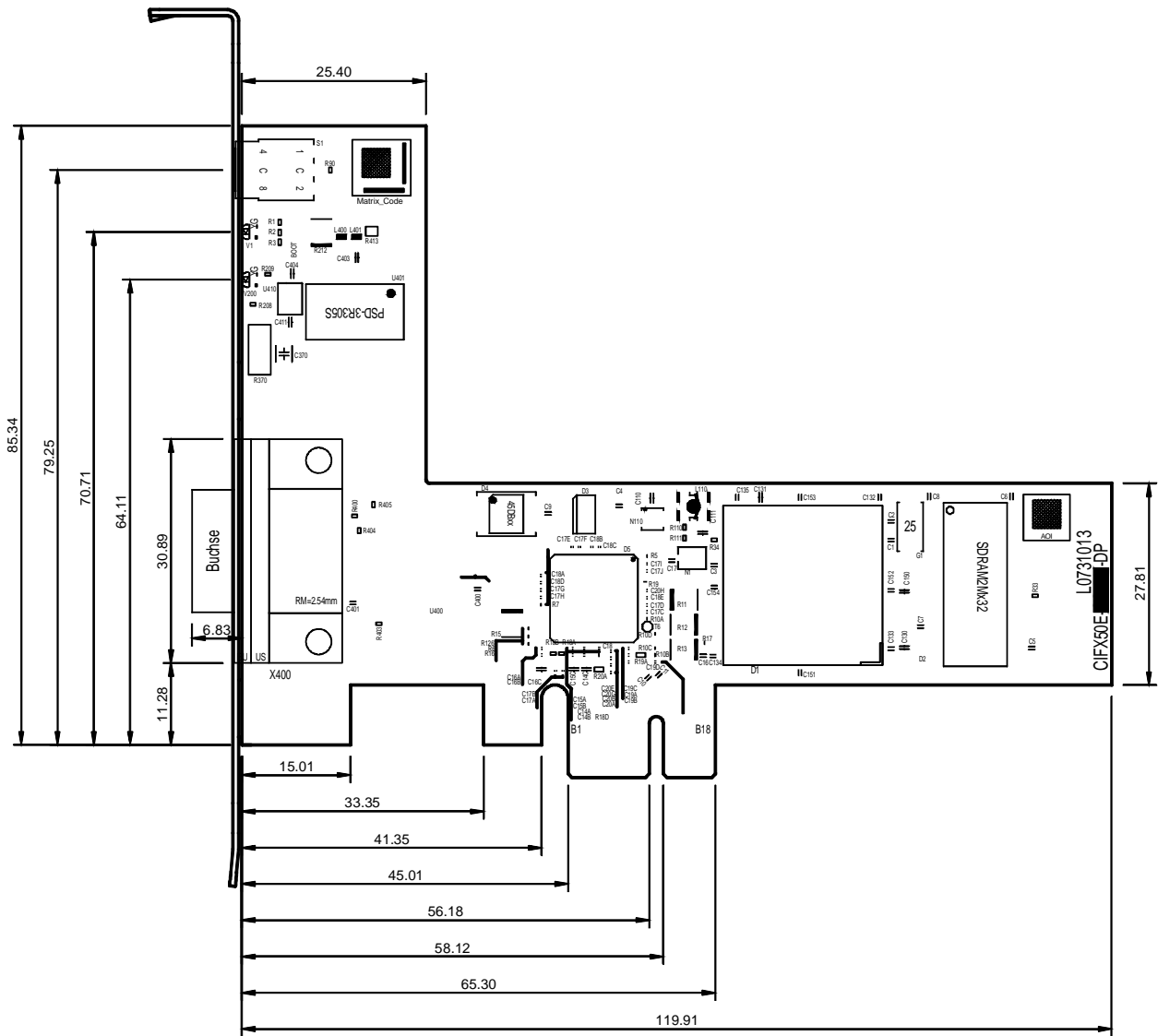
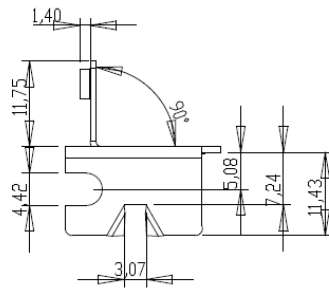

Figure 73: Dimensions CIFX 50E-DP (Hardware Rev.6)

### 11.3.7 Front Panel CIFX 50-DP or CIFX 50E-DP



Material:  
Edelstahl gebürstet 0,8 mm  
Toleranzen:  
Bohrdurchmesser: +/- 0,05 mm  
Längenmaß: +/- 0,1 mm

Material :  
Brushed stainless steel 0.8 mm  
Tolerances:  
Drilling diameter : +/- 0.05 mm  
Length: +/- 0.1 mm

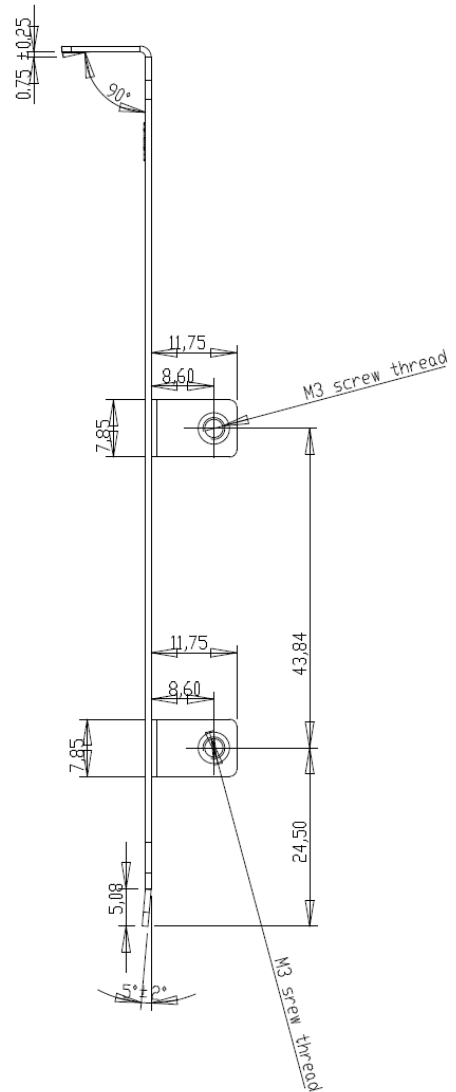
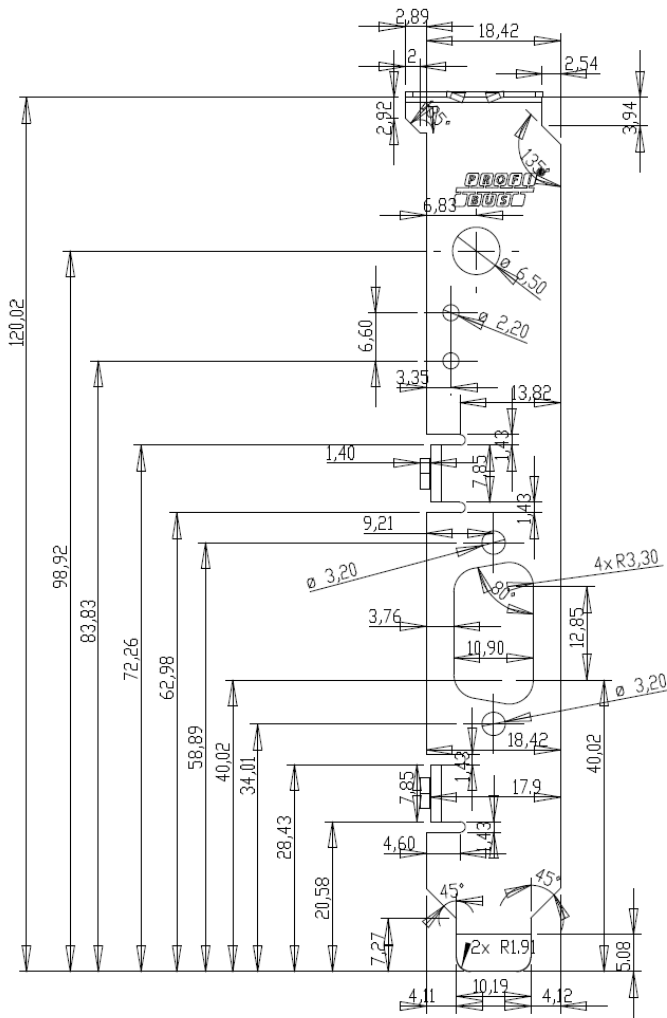

Figure 74: Dimensions Front Panel CIFX 50-DP or CIFX 50E-DP

### 11.3.8 CIFX 50-CO, CIFX 50E-CO

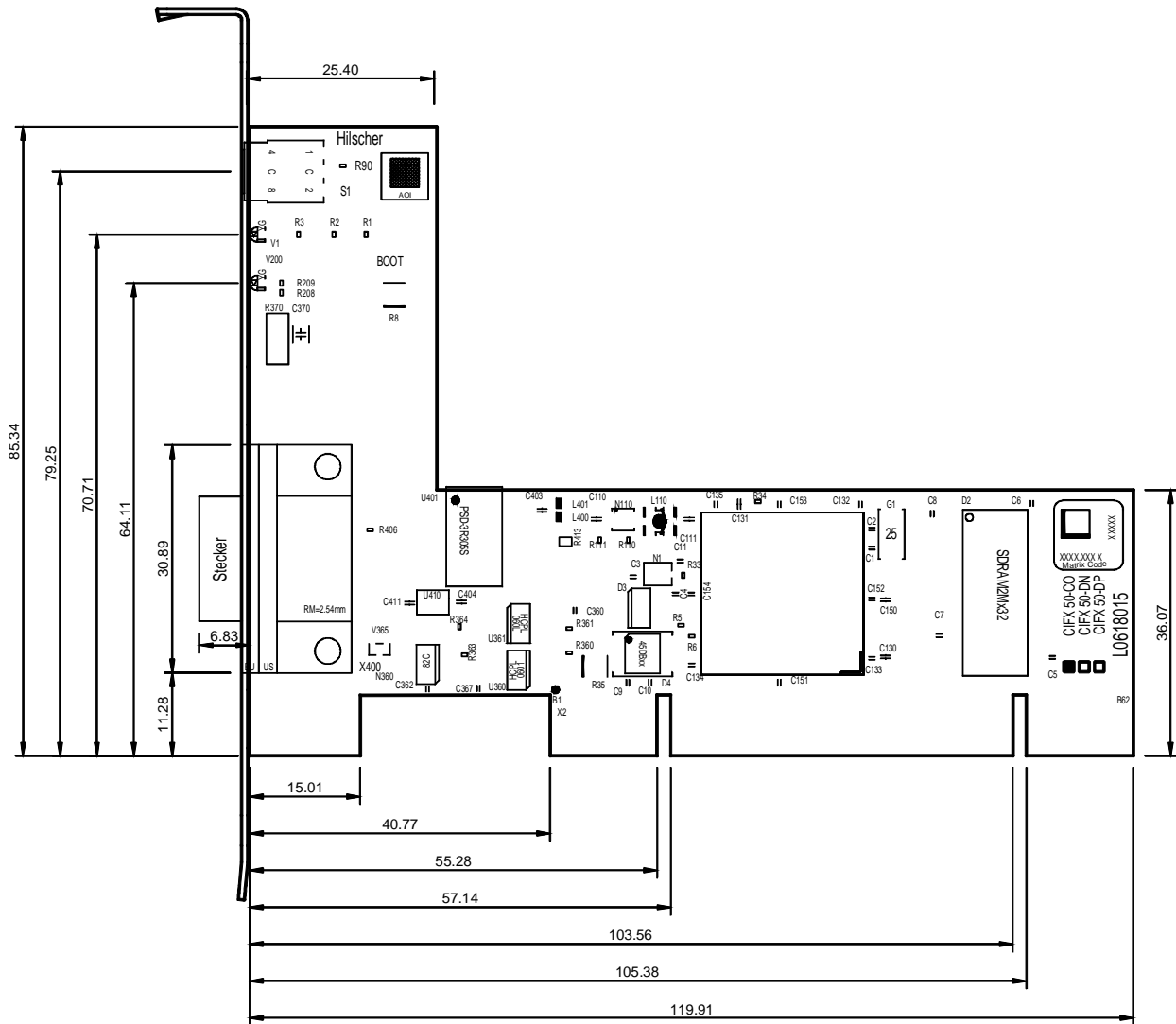

Figure 75: Dimensions CIFX 50-CO (Hardware Rev.5)

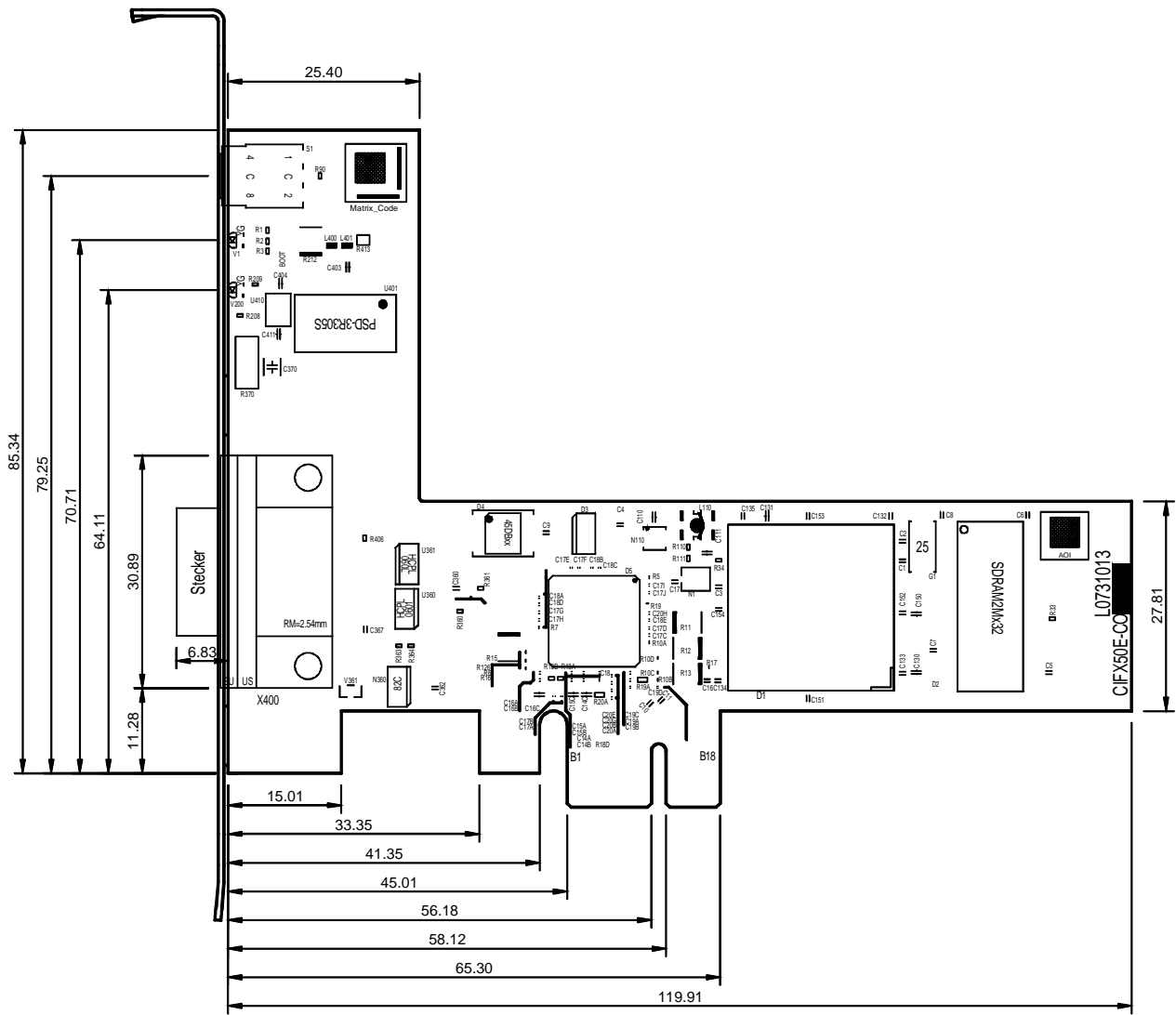

Figure 76: Dimensions CIFX 50E-CO (from Hardware Rev.4)

### 11.3.9 Front Panel CIFX 50-CO or CIFX 50E-CO

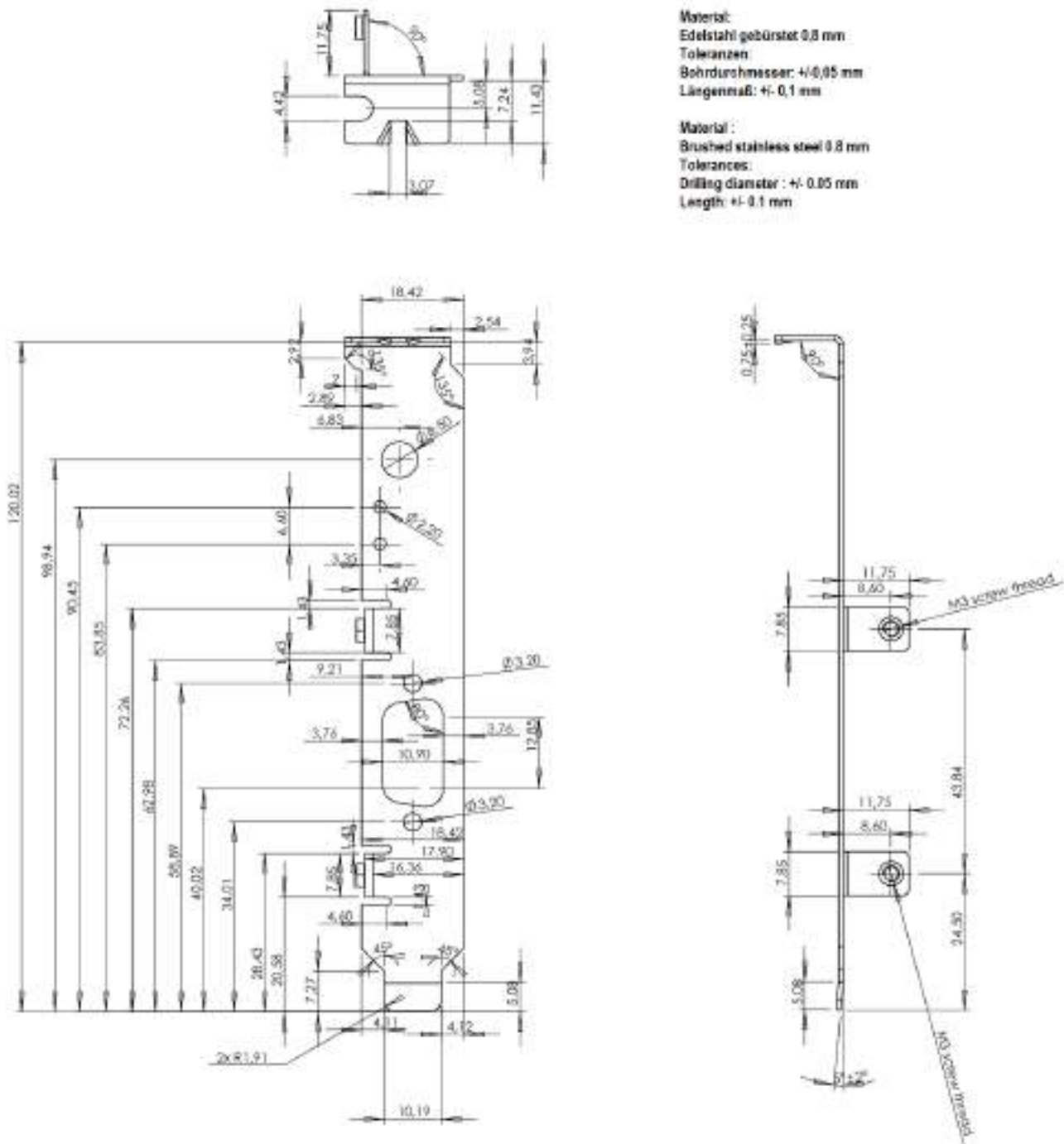

Figure 77: Dimensions Front Panel für CIFX 50-CO or CIFX 50E-CO





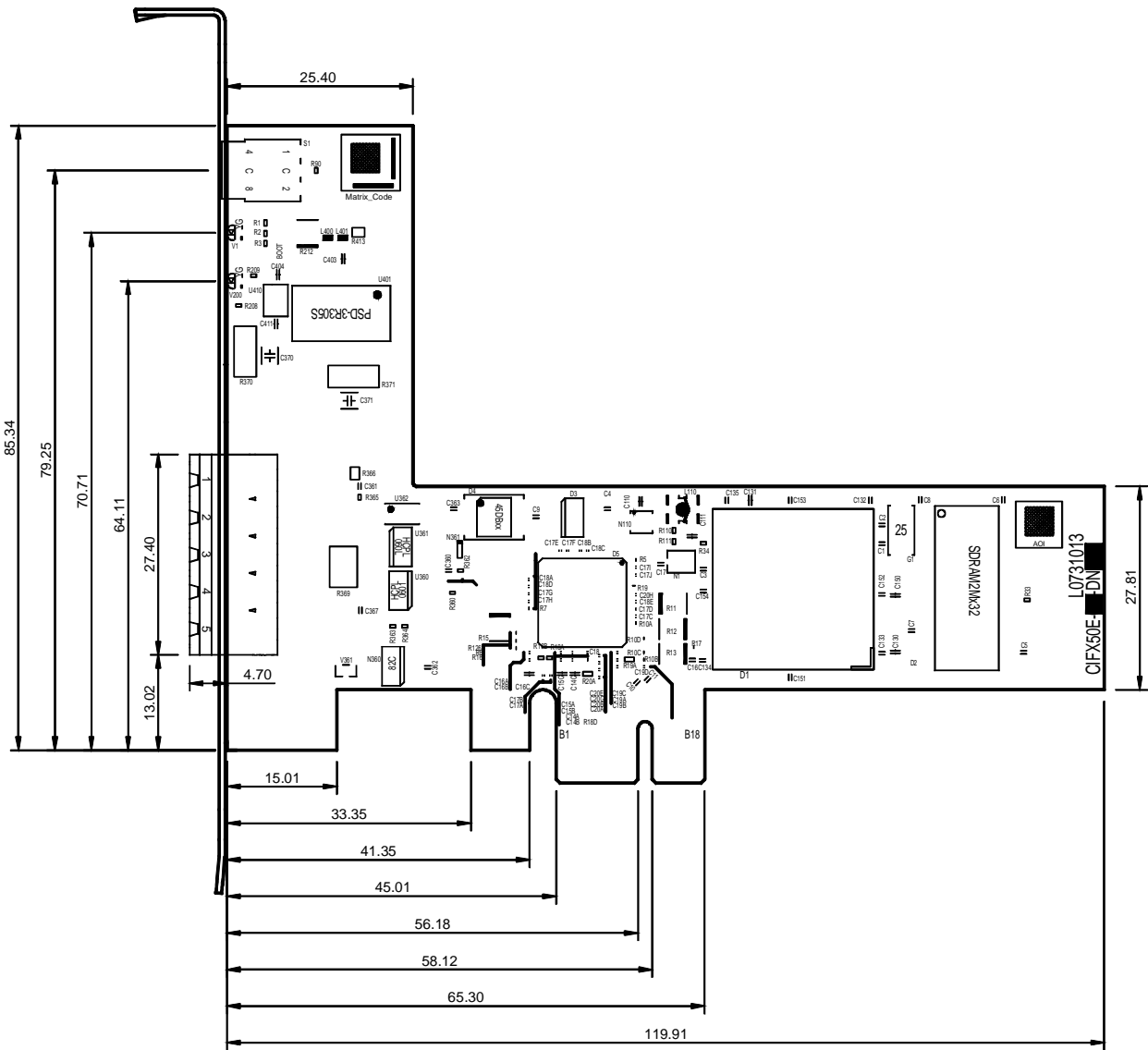

Figure 79: Dimensions CIFX 50E-DN (from Hardware Rev.4)



### 11.3.12 CIFX 50-CC, CIFX 50E-CC

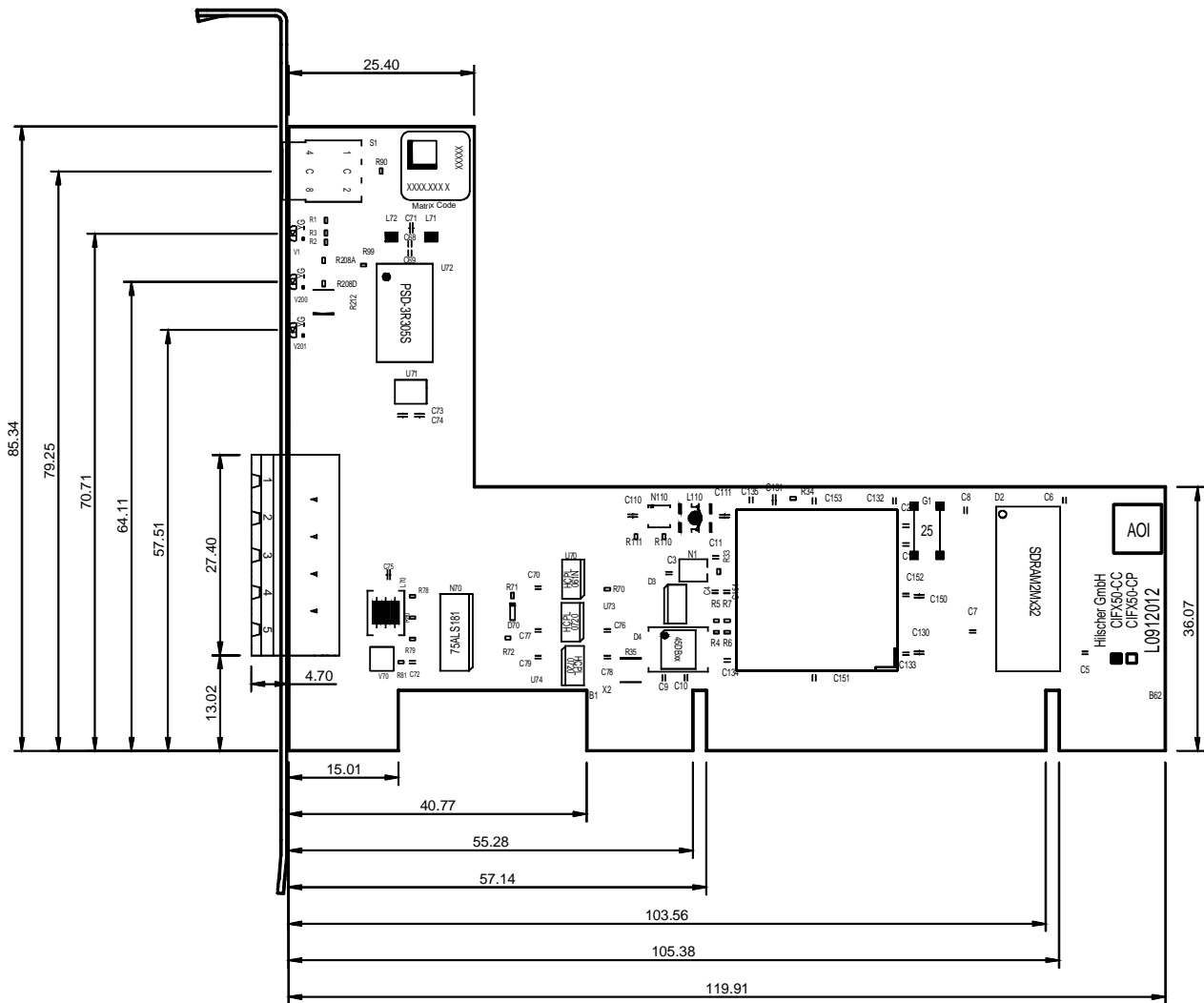

Figure 81: Dimensions CIFX 50-CC (Hardware Rev.2)

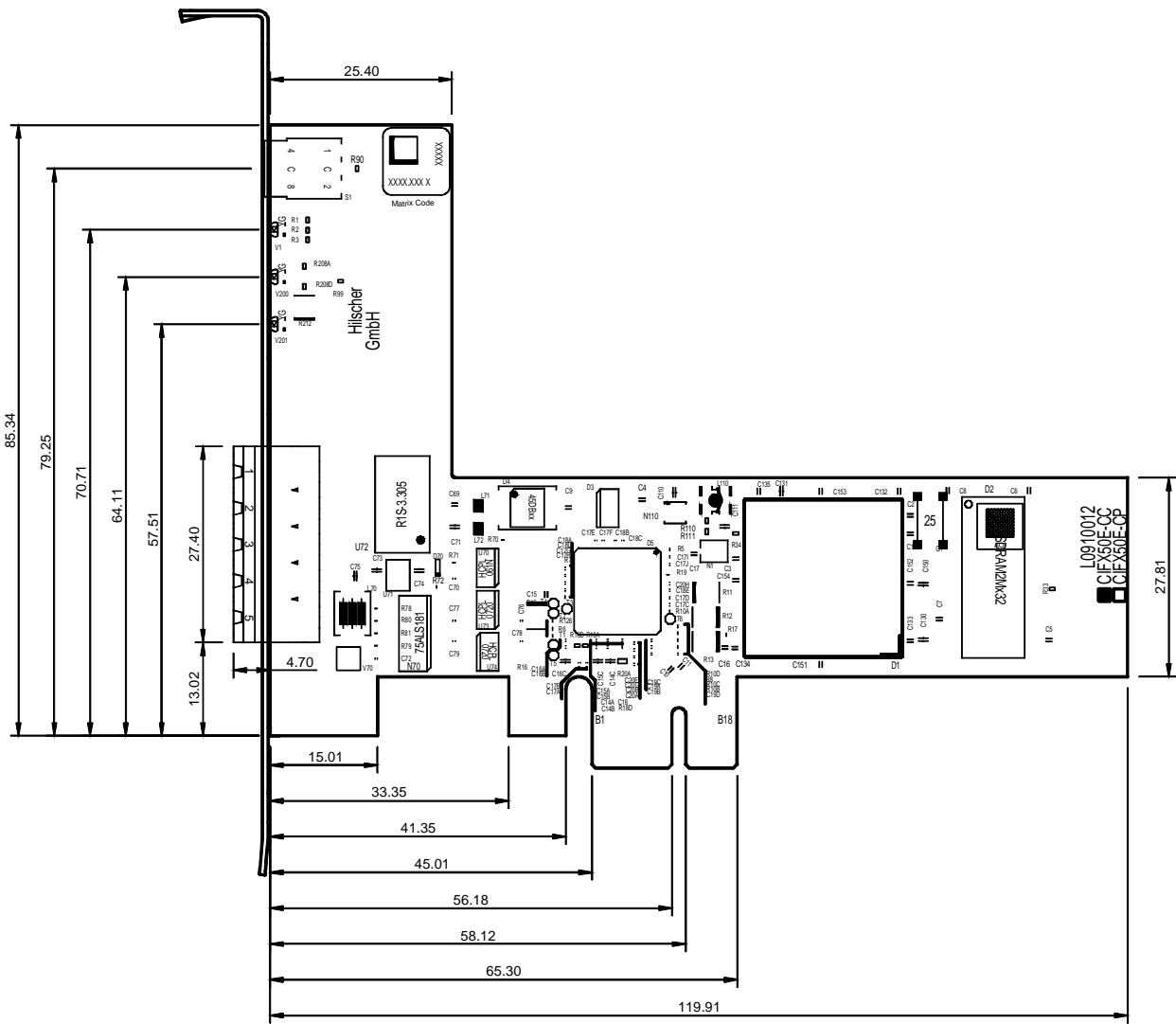
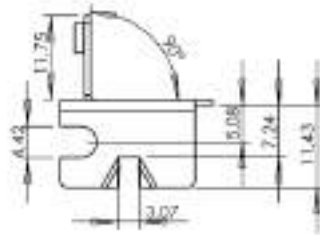

Figure 82: Dimensions CIFX 50E-CC (from Hardware Rev.4)

### 11.3.13 Front Panel CIFX 50-CC or CIFX 50E-CC



Material:  
Edelstahl gebürstet 0,8 mm  
Toleranzen:  
Bohrdurchmesser:  $\pm 0,05$  mm  
Längenmaß:  $\pm 0,1$  mm

Material:  
Brushed stainless steel 0.8 mm  
Tolerances:  
Drilling diameter:  $\pm 0.05$  mm  
Length:  $\pm 0.1$  mm

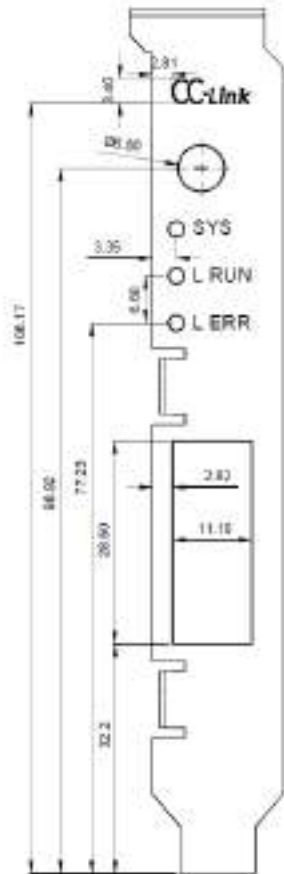

Figure 83: Dimensions Front Panel CIFX 50-CC or CIFX 50E-CC

### 11.3.14 CIFX 50-2DP

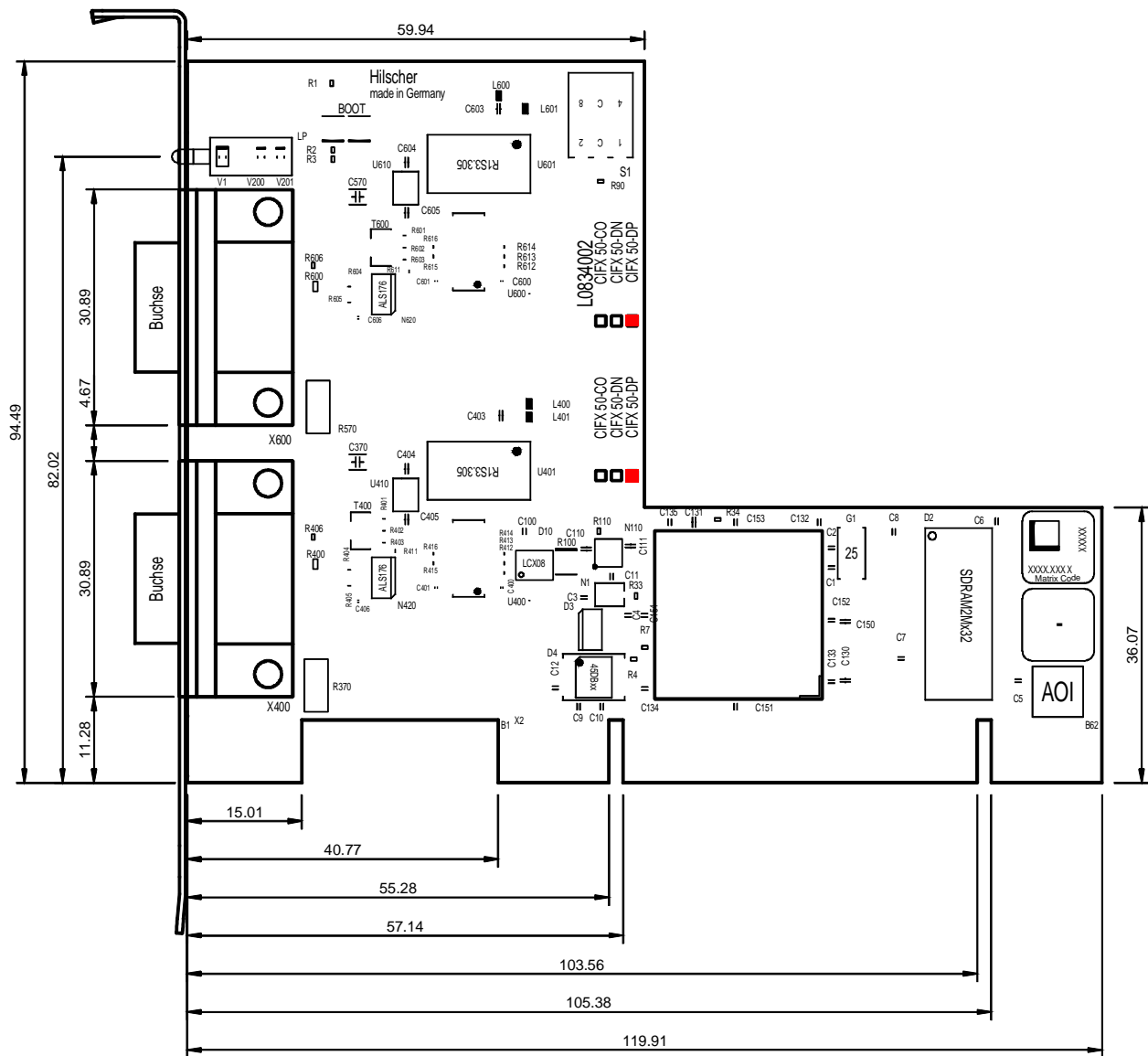

Figure 84: Dimensions CIFX 50-2DP (Hardware Rev.3)



### 11.3.16 CIFX 50-2DP\CO

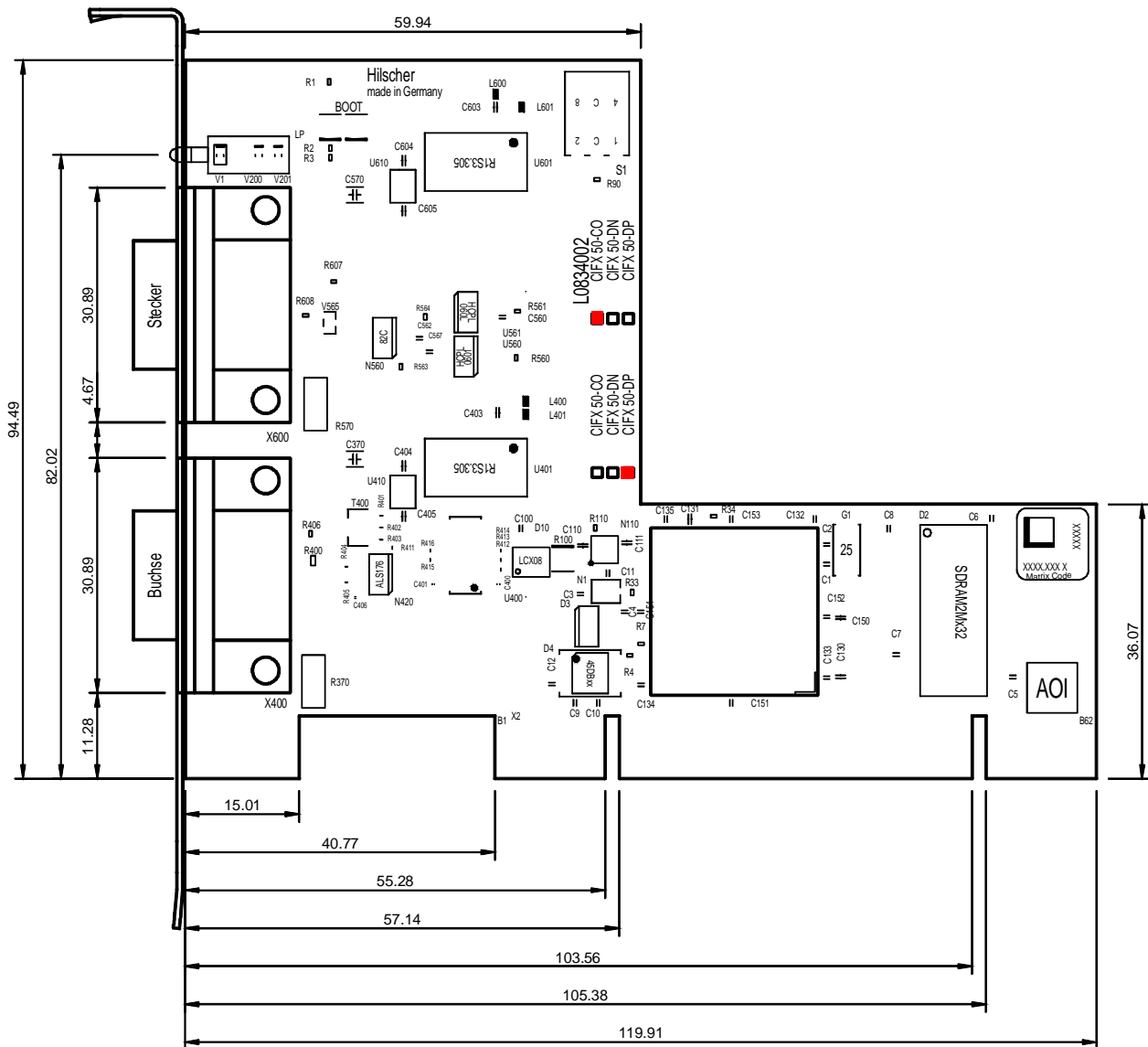

Figure 86: Dimensions CIFX 50-2DP\CO (Hardware Rev.2)



### 11.3.17 CIFX 50E-2DP\CO

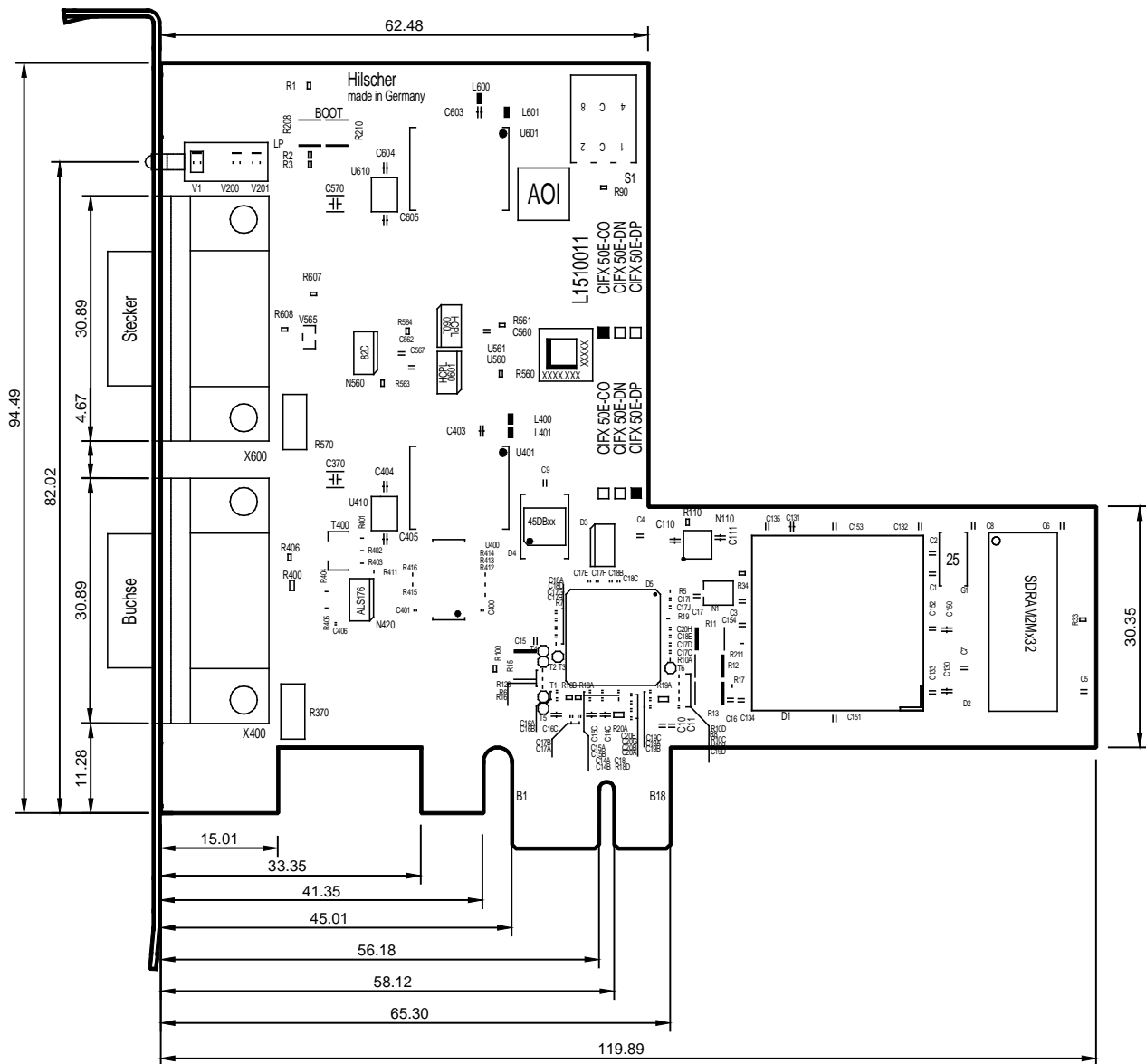

Figure 87: Dimensions CIFX 50E-2DP\CO (Hardware Rev. 1)



### 11.3.19 CIFX 50E-2DP\DN

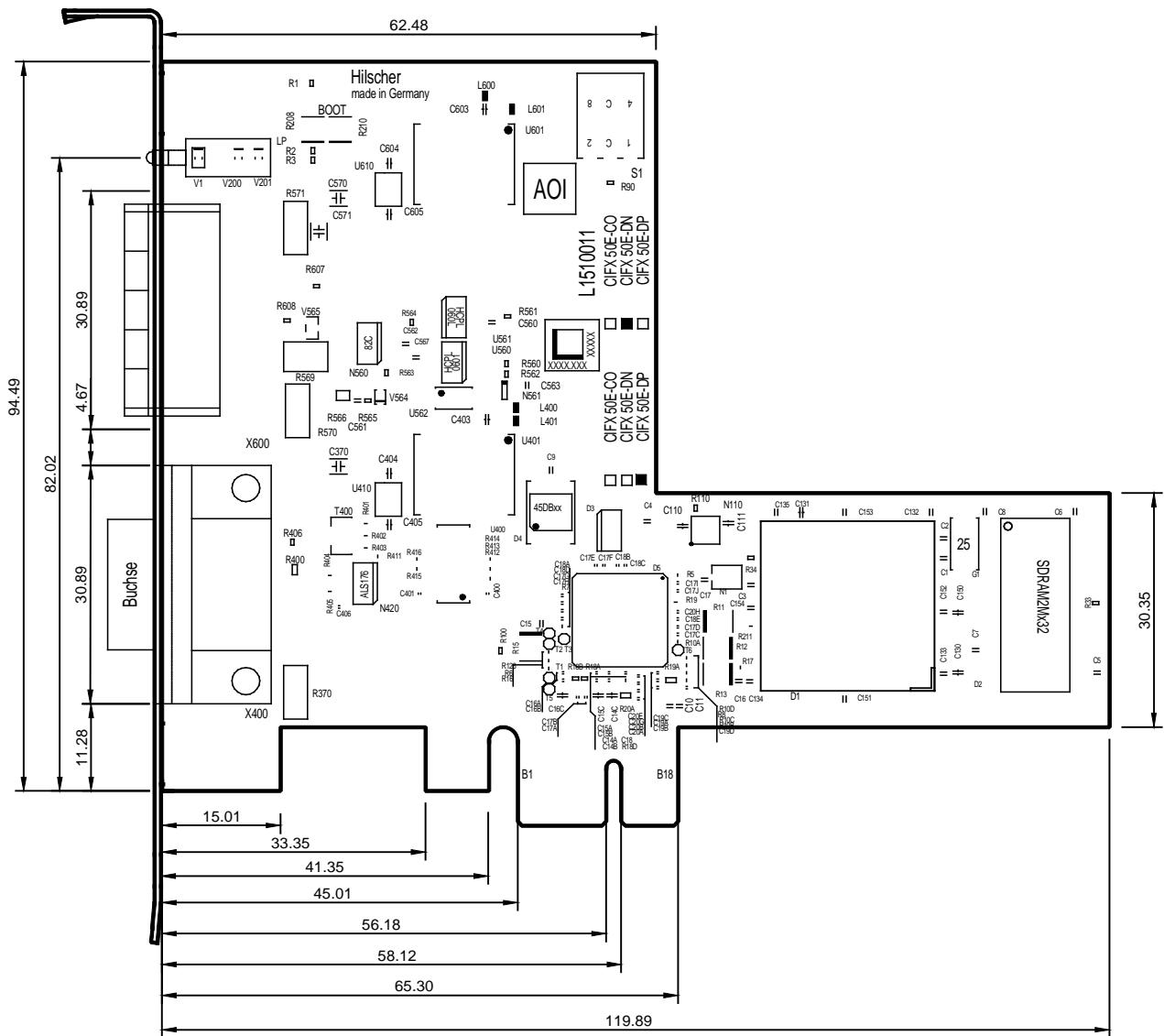

Figure 89: Dimensions CIFX 50E-2DP\DN (Hardware Rev. 1)

### 11.3.20 CIFX 50-2CO

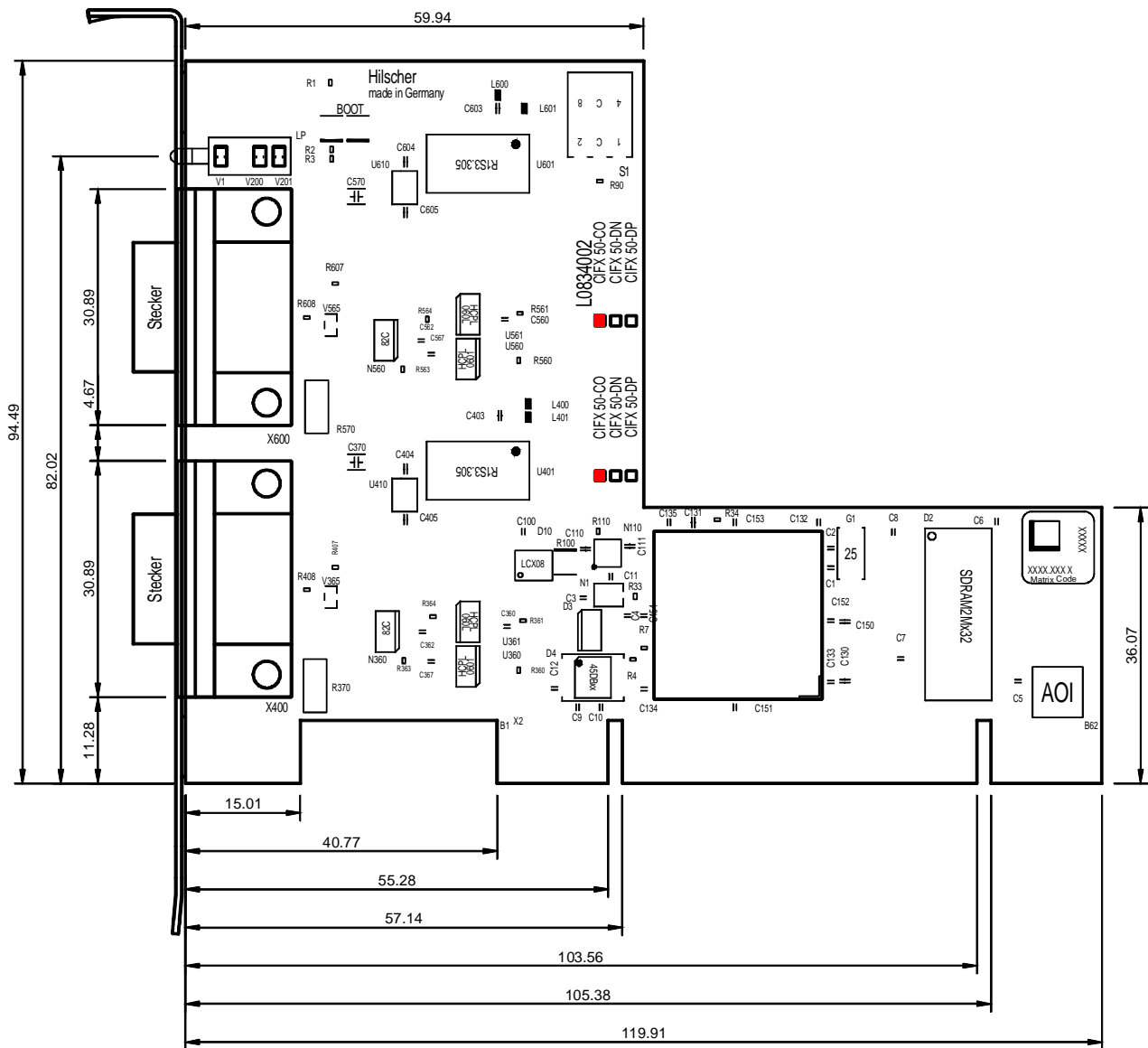
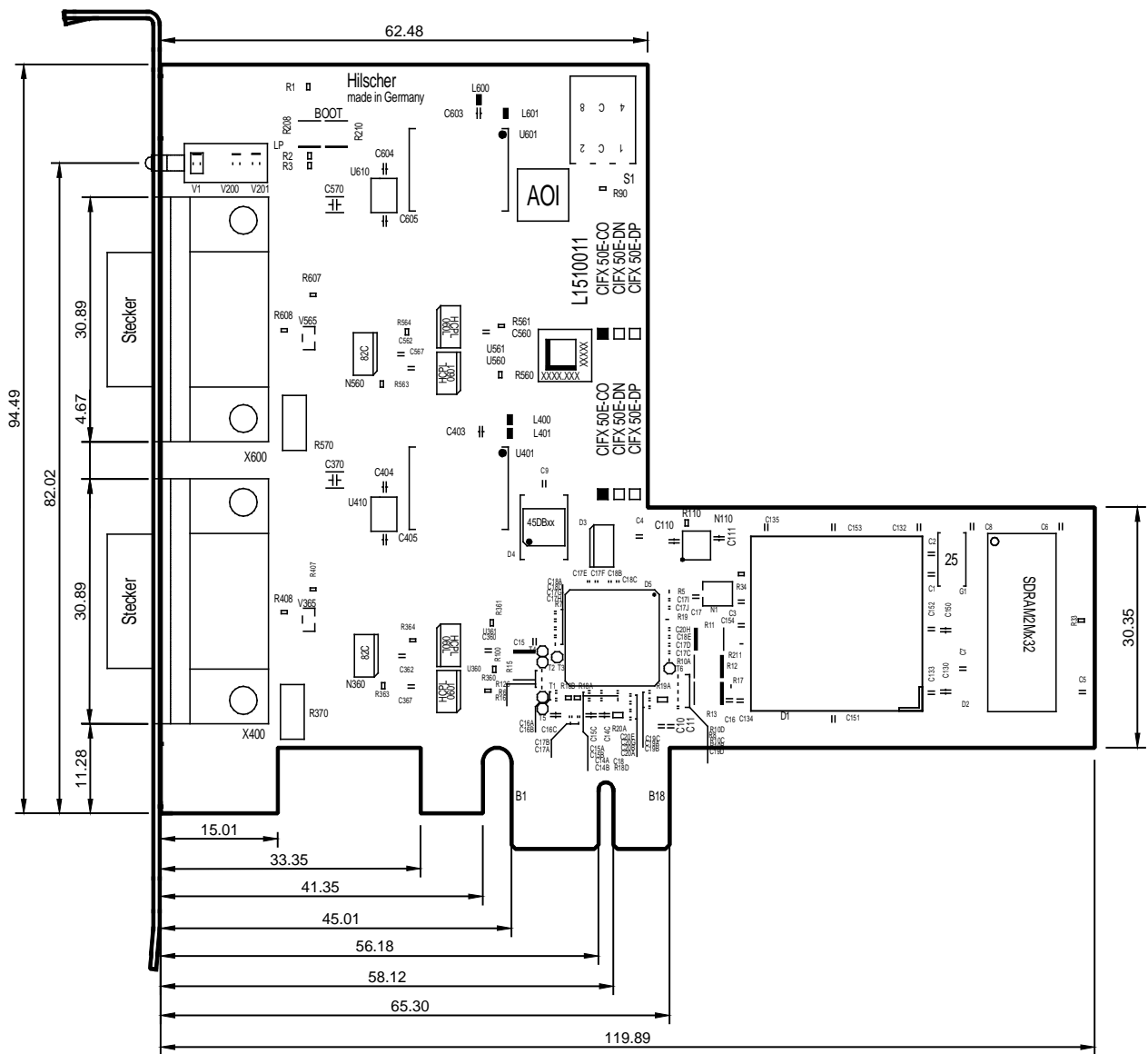

Figure 90: Dimensions CIFX 50-2CO (Hardware Rev.2)

### 11.3.21 CIFX 50E-2CO





### 11.3.23 CIFX 50E-2CO\DN

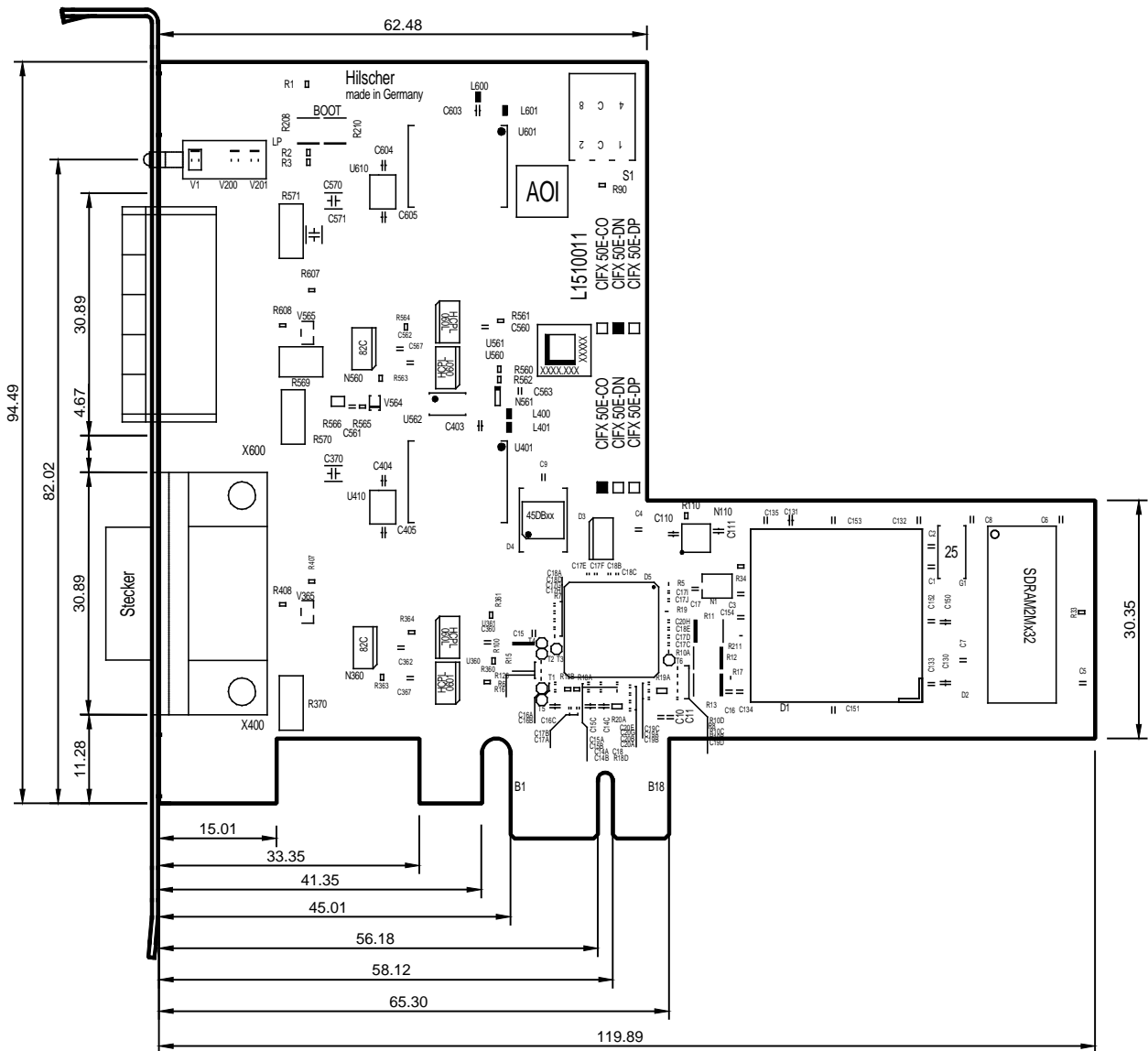

Figure 93: Dimensions CIFX 50E-2CO\DN (Hardware Rev. 1)

### 11.3.24 CIFX 50-2DN

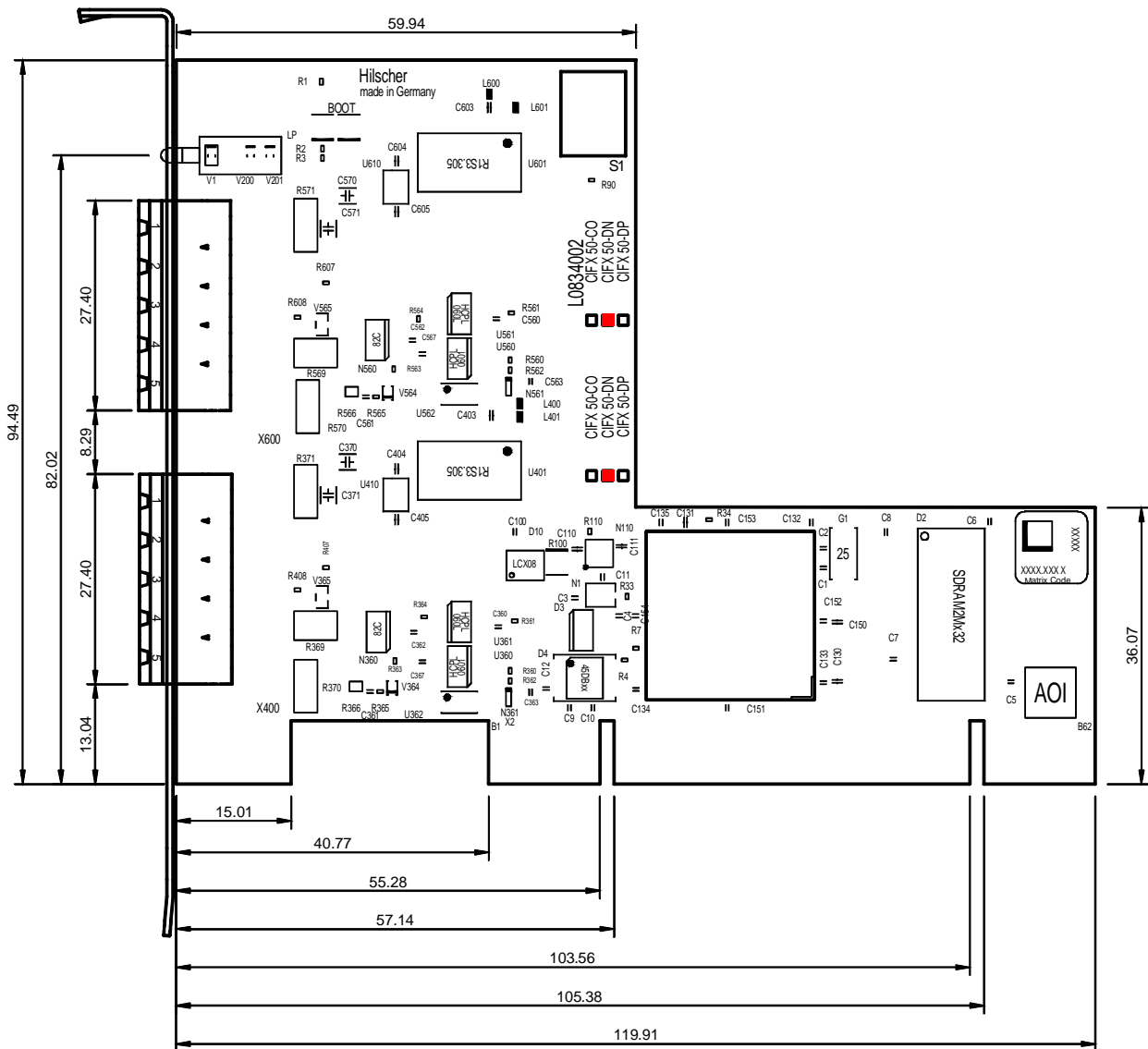

Figure 94: Dimensions CIFX 50-2DN (Hardware Rev.2)



### 11.3.25 CIFX 50E-2DN

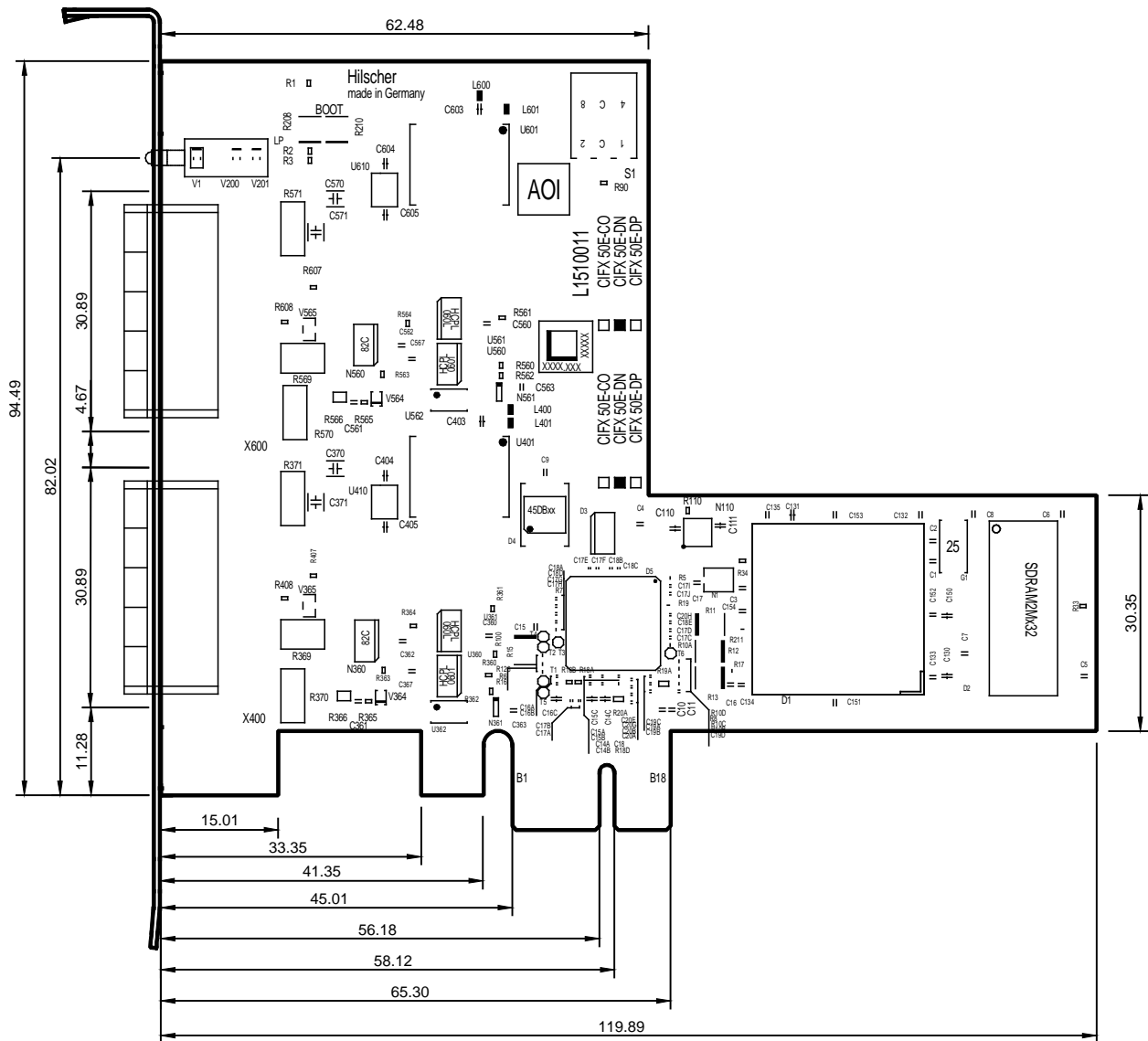

Figure 95: Dimensions CIFX 50E-2DN (Hardware Rev. 1)

### 11.3.26 Front Panel CIFX 50-2FB

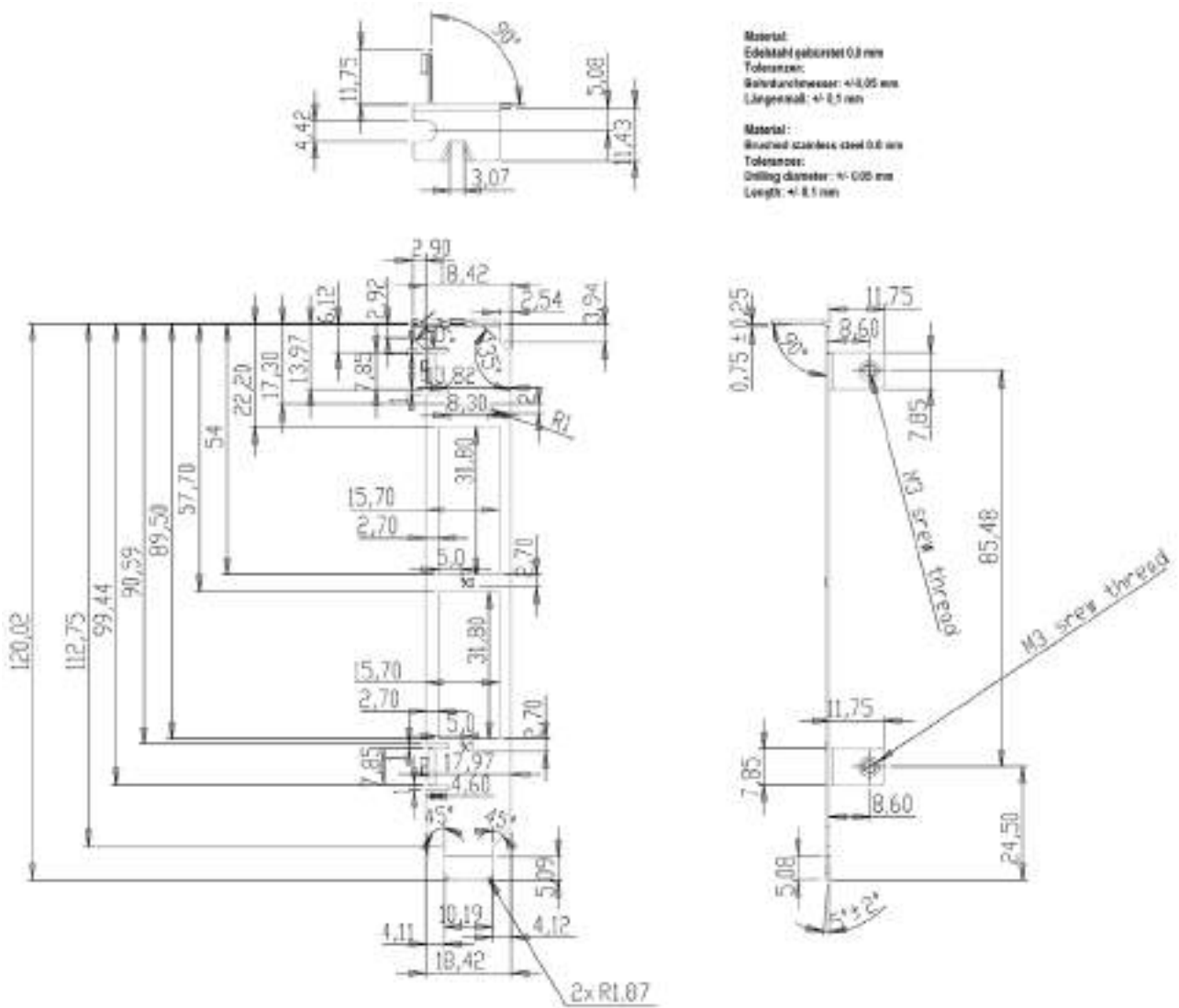

Figure 96: Dimensions Front Panel CIFX 50-2FB

### 11.3.27 CIFX 50-2ASM, CIFX 50E-2ASM

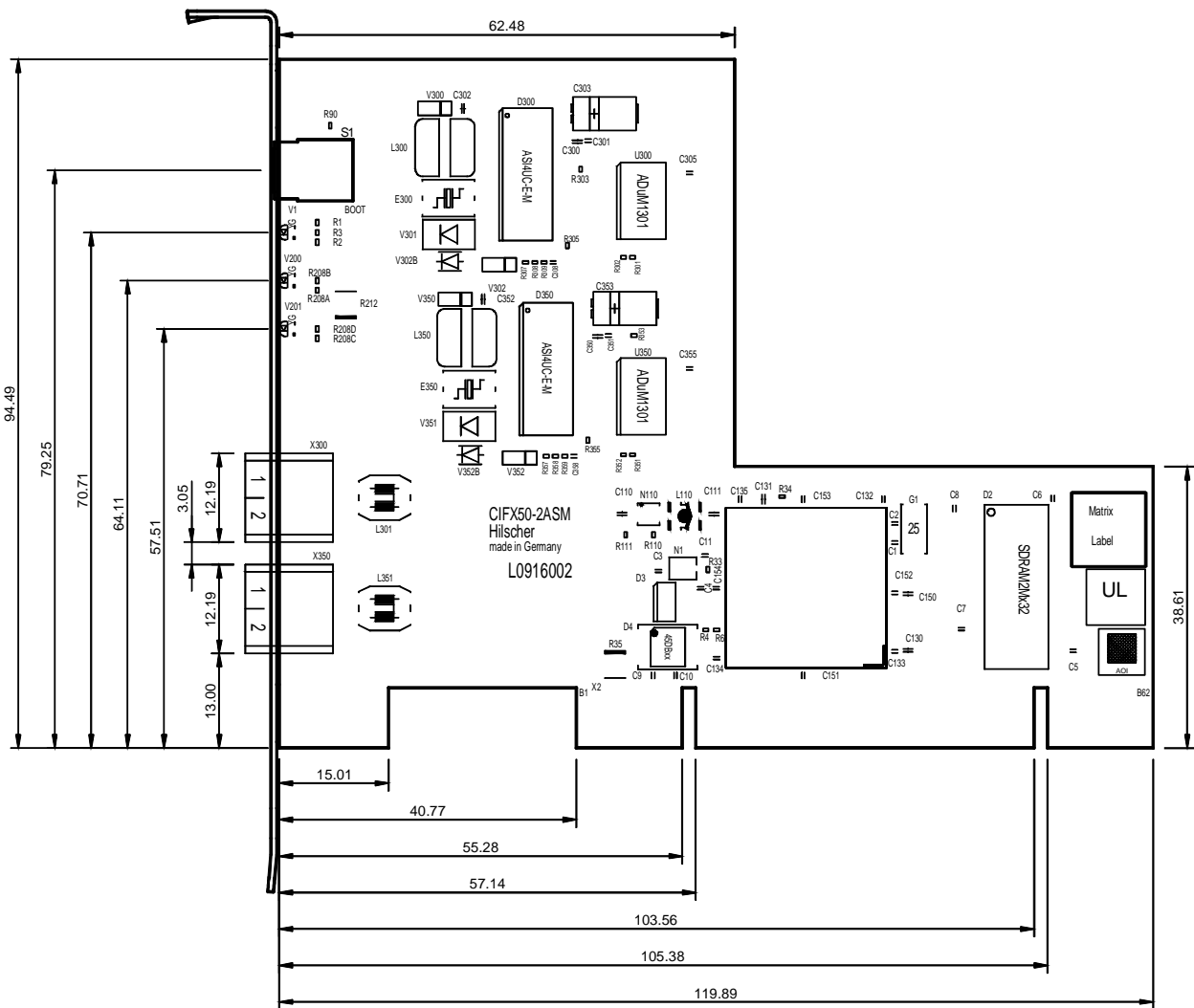
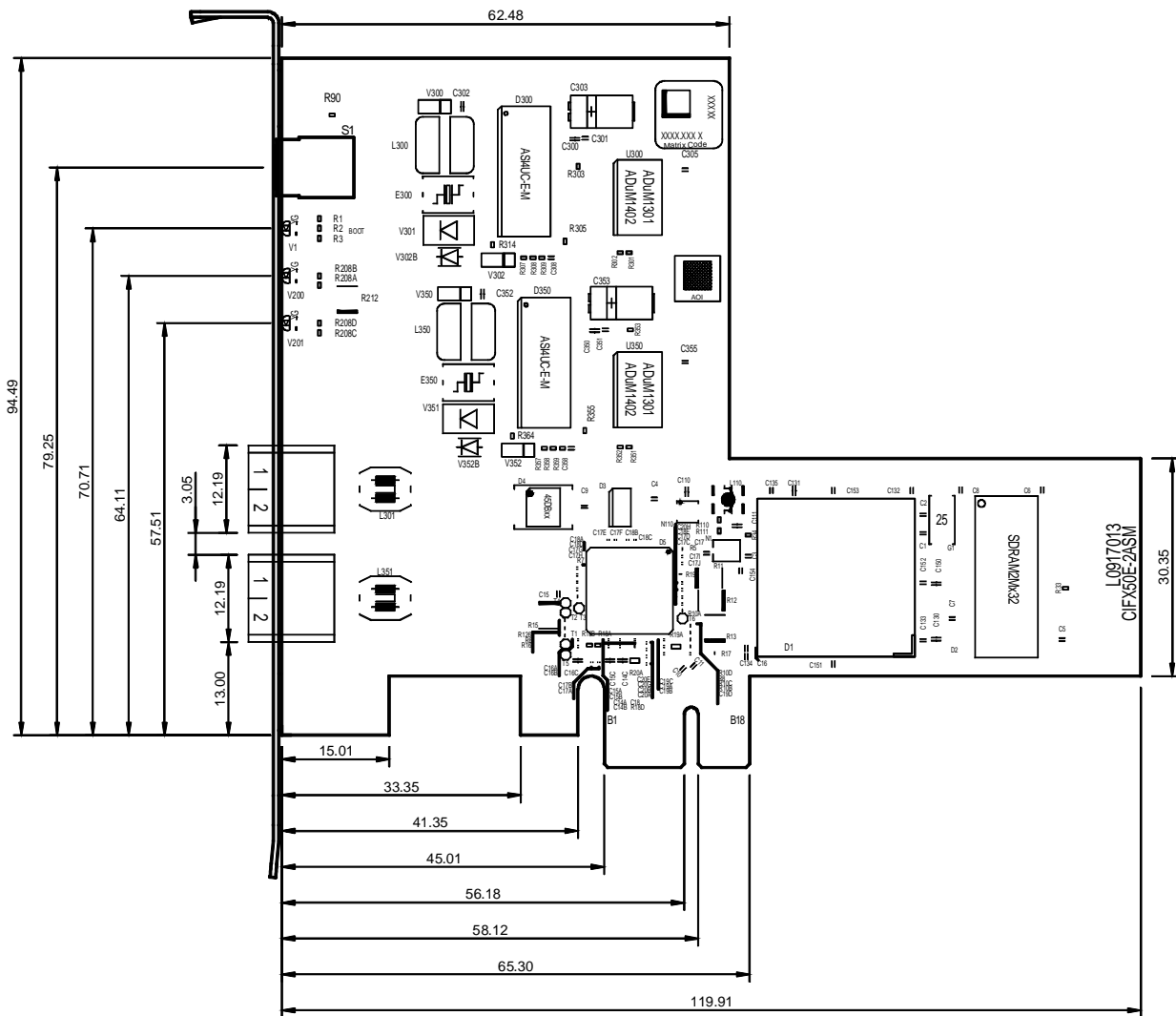
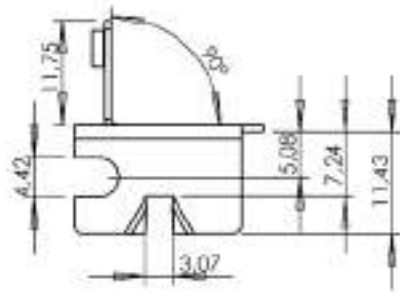

Figure 97: Dimensions CIFX 50-2ASM (Hardware Rev.2)



### 11.3.28 Front Panel CIFX 50-2ASM, CIFX 50E-2ASM



Material:  
Edelstahl gebürstet 0,8 mm  
Toleranzen:  
Bohrdurchmesser:  $\pm 0,05$  mm  
Längenmaß:  $\pm 0,1$  mm

Material :  
Brushed stainless steel 0.8 mm  
Tolerances:  
Drilling diameter :  $\pm 0.05$  mm  
Length:  $\pm 0.1$  mm

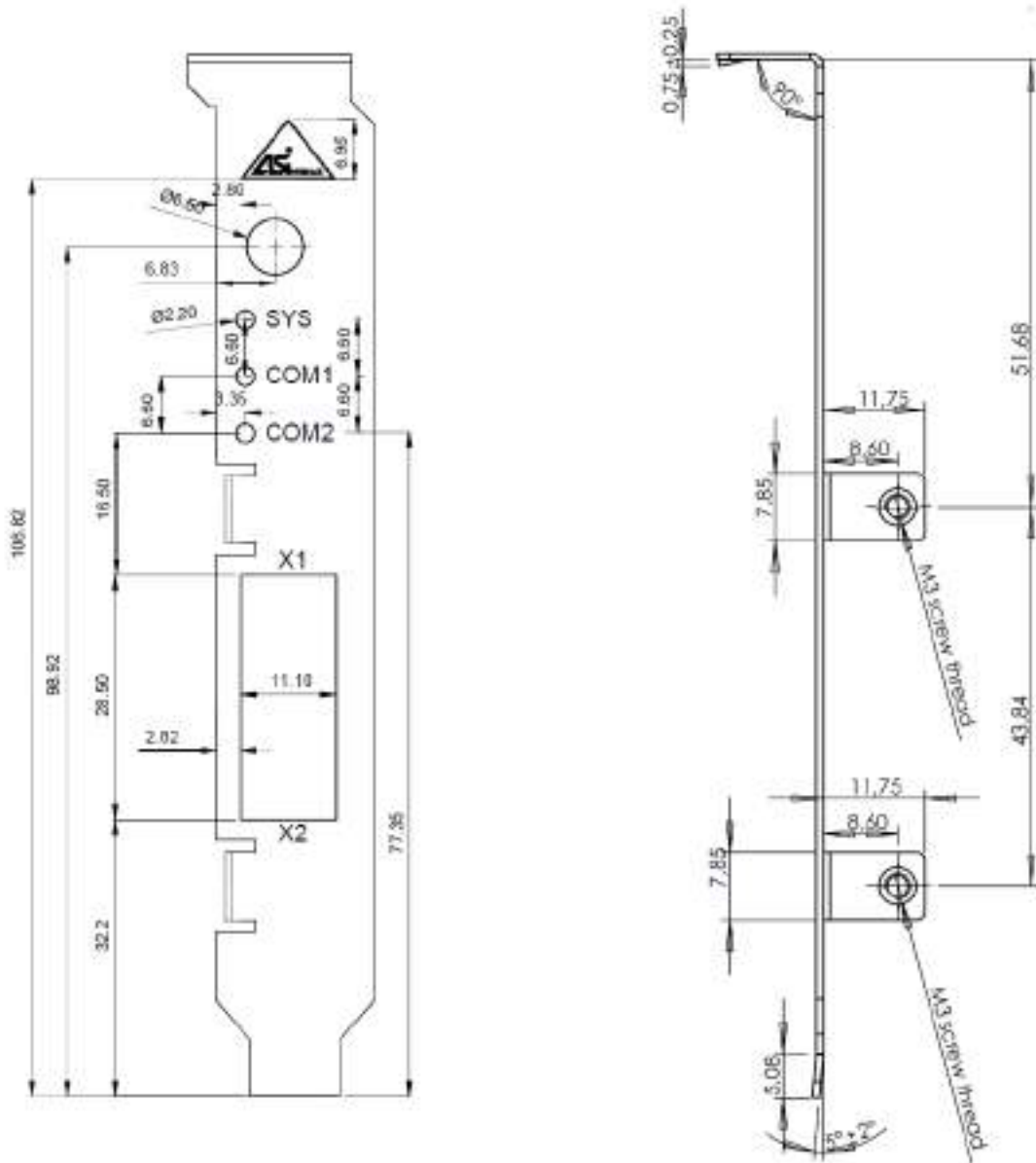

Figure 99: Dimensions Front Panel CIFX 50-2ASM, CIFX 50E-2ASM

# 11.4 Dimensions PC Cards cifX Low Profile PCI Express

## 11.4.1 CIFX 70E-RE, CIFX 70E-REMR

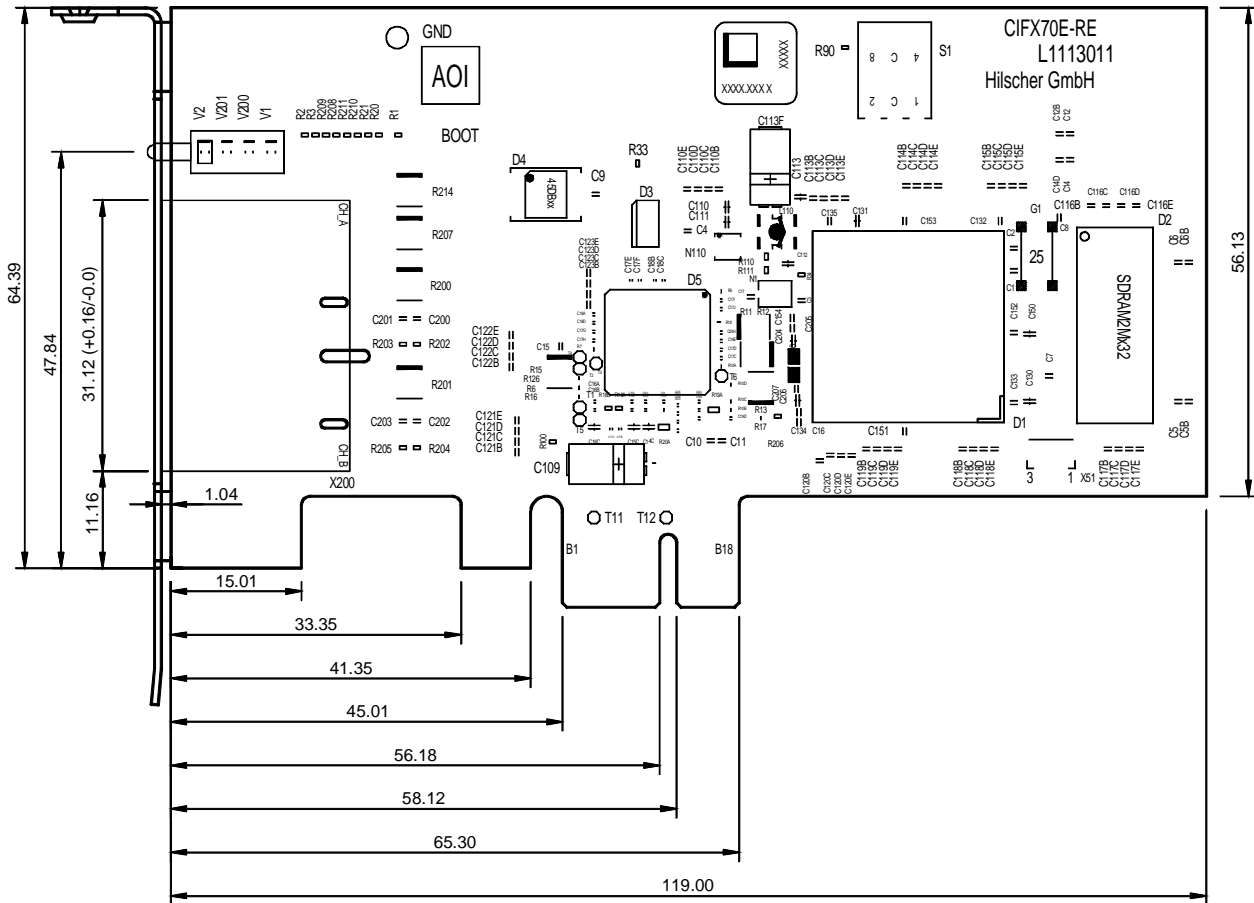

Figure 100: Dimensions CIFX 70E-RE and CIFX 70E-REMR (Hardware Rev.1)



### 11.4.3 CIFX 70E-CCIES

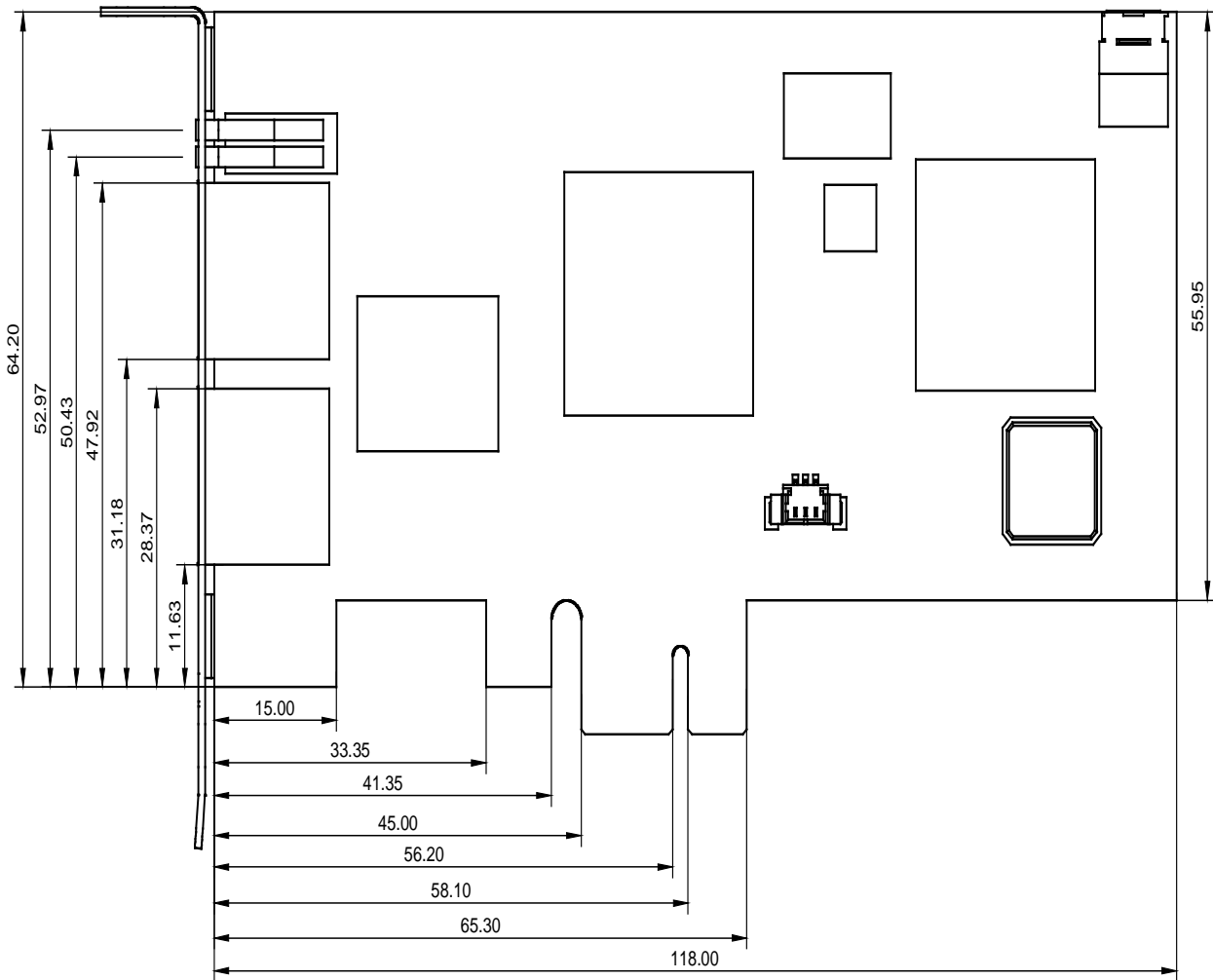
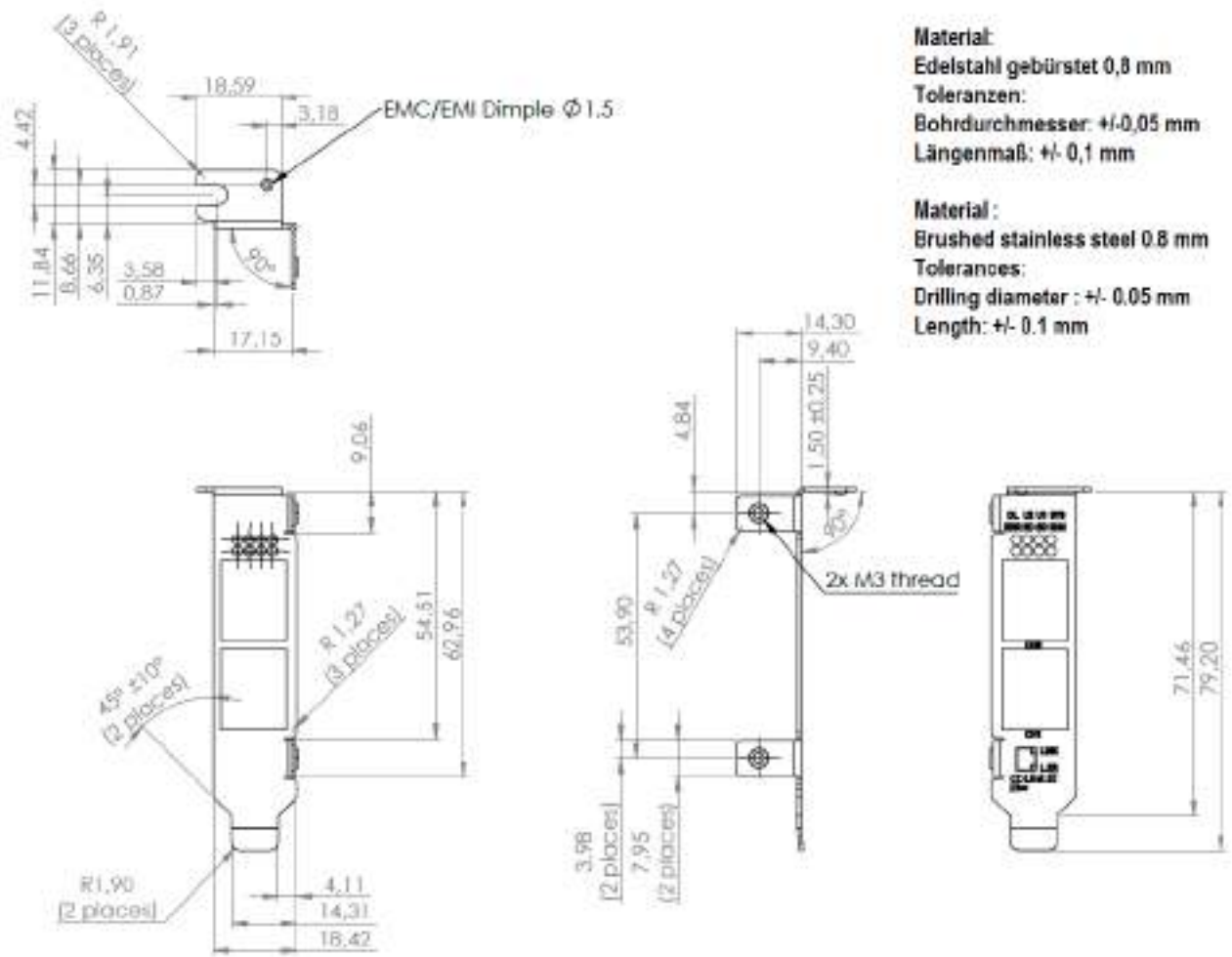

Figure 102: Dimensions CIFX 70E-CCIES (from Hardware Rev. 1)



### 11.4.4 Front Panel CIFX 70-CCIES



**Blenden-Ausschnitt    Panel cutout**

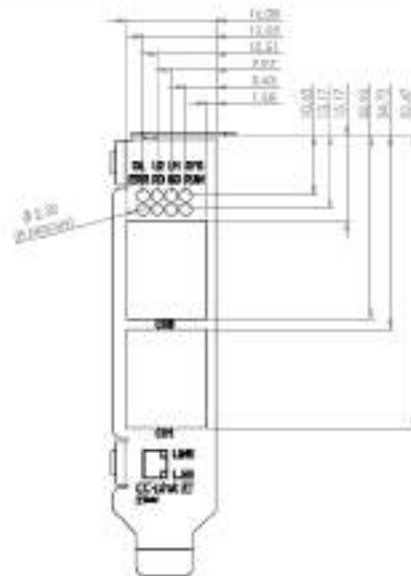

Figure 103: Dimensions Front Panel CIFX 70E-CCIES

### 11.4.5 CIFX 70E-DP, CIFX 70E-DPWR

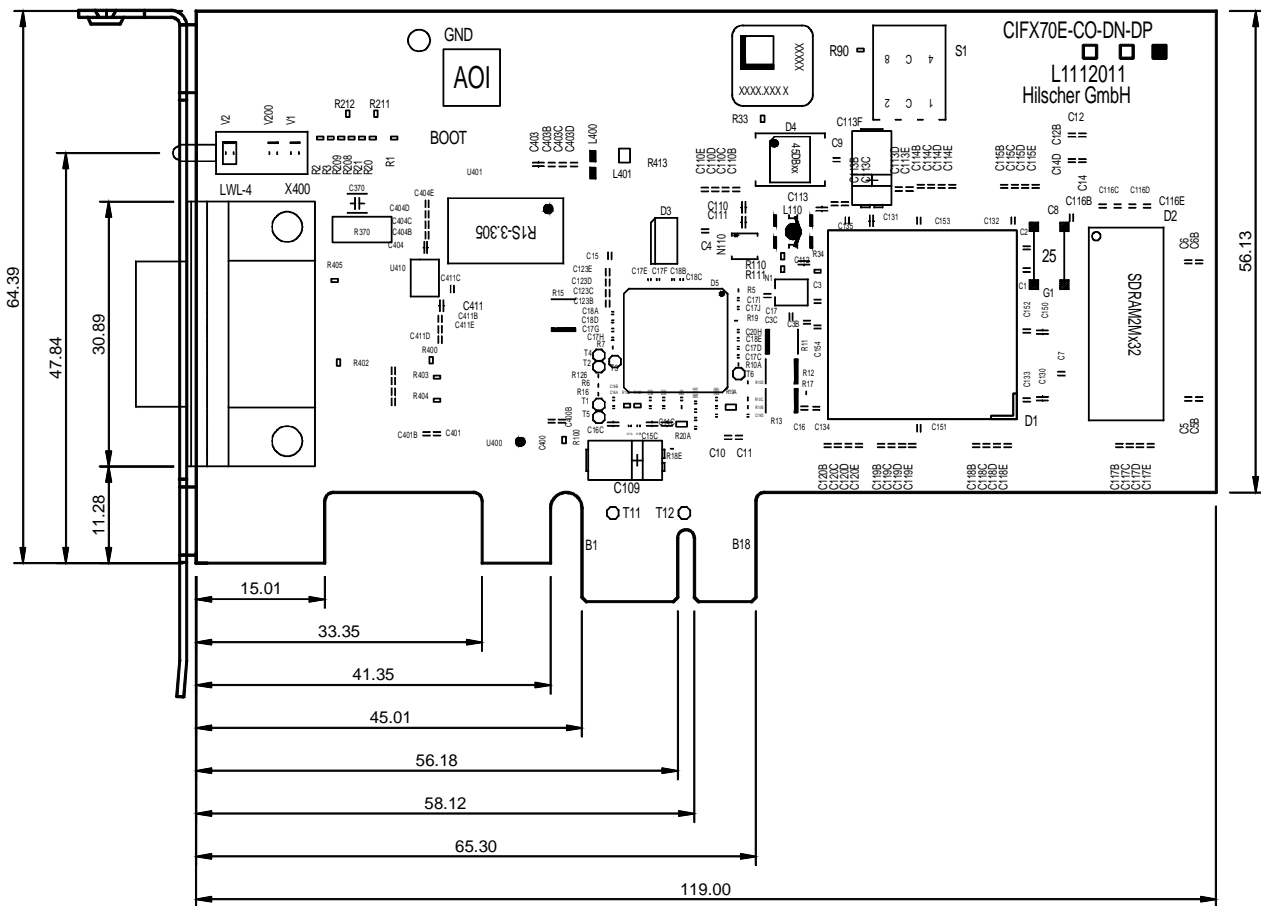

Figure 104: Dimensions CIFX 70E-DP and CIFX 70E-DPWR (Hardware Rev.1)

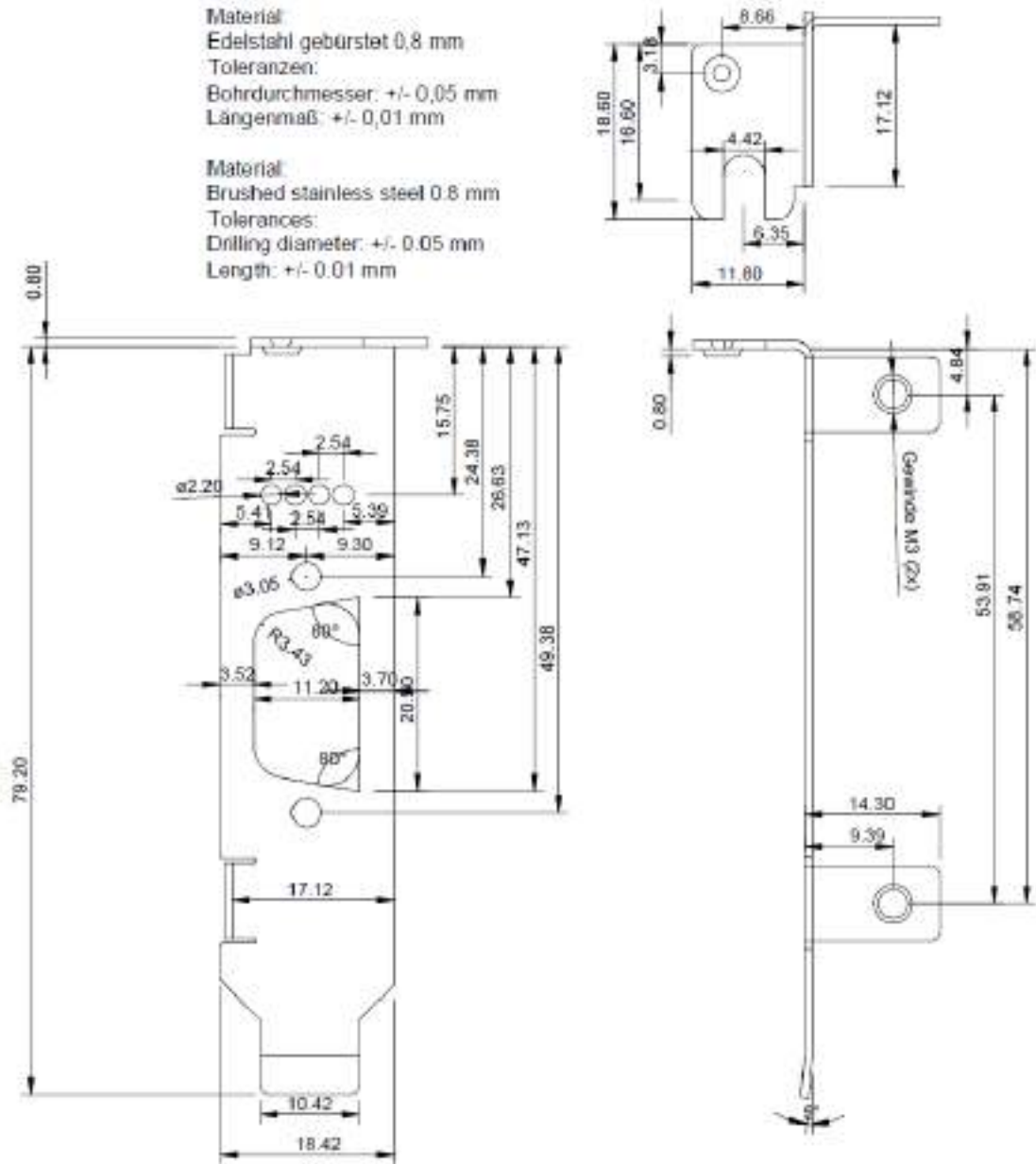

Figure 105: Blende für CIFX 70E-DP, CIFX 70E-DPWR

### 11.4.6 CIFX 70E-CO, CIFX 70E-CO\MR

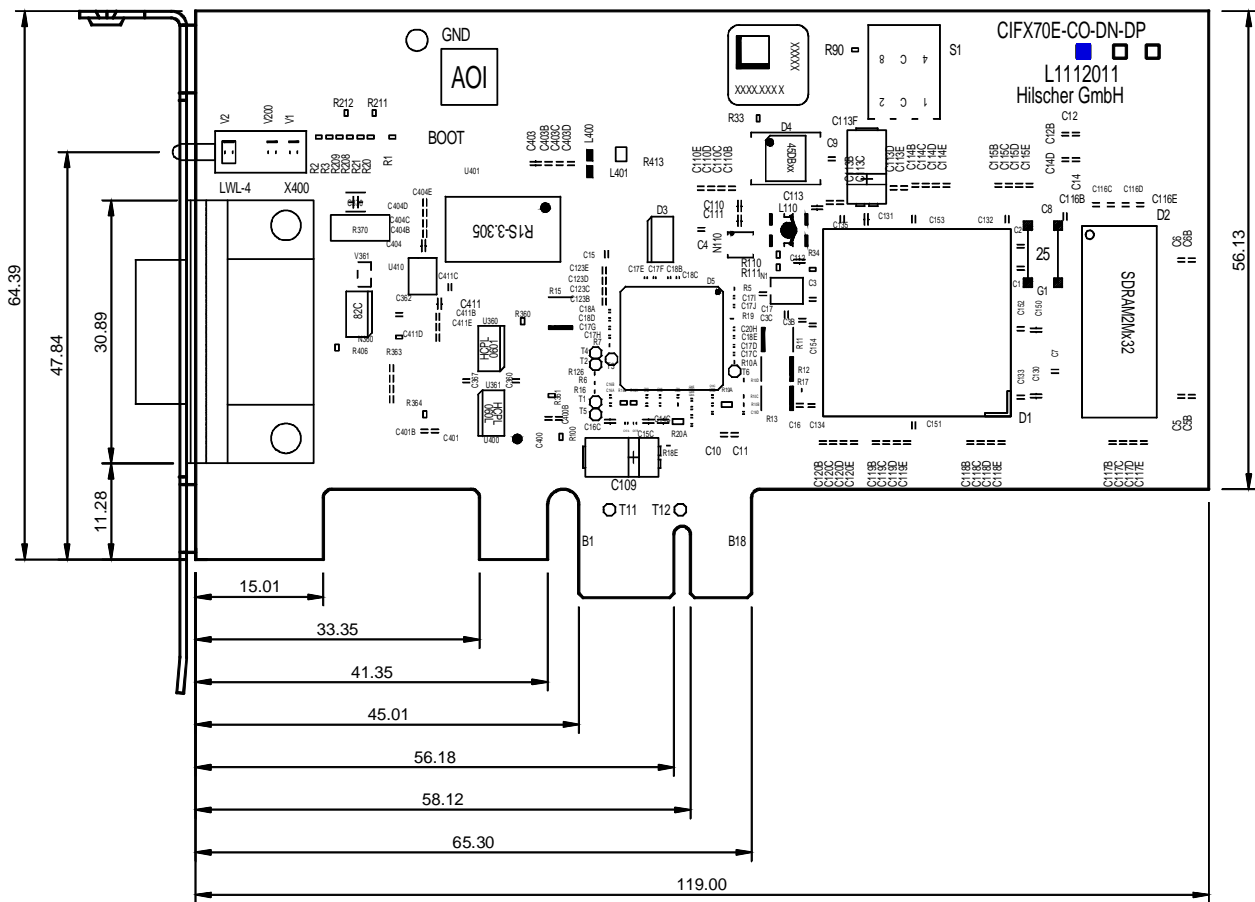

Figure 106: Dimensions CIFX 70E-CO and CIFX 70E-CO\MR (Hardware Rev. 1)

### 11.4.7 Front Panel CIFX 70E-CO, CIFX 70E-COMR

Material:  
Edelstahl gebürstet 0,8 mm  
Toleranzen:  
Bohrdurchmesser: +/- 0,05 mm  
Längenmaß: +/- 0,01 mm

Material:  
Brushed stainless steel 0.8 mm  
Tolerances:  
Drilling diameter: +/- 0.05 mm  
Length: +/- 0.01 mm

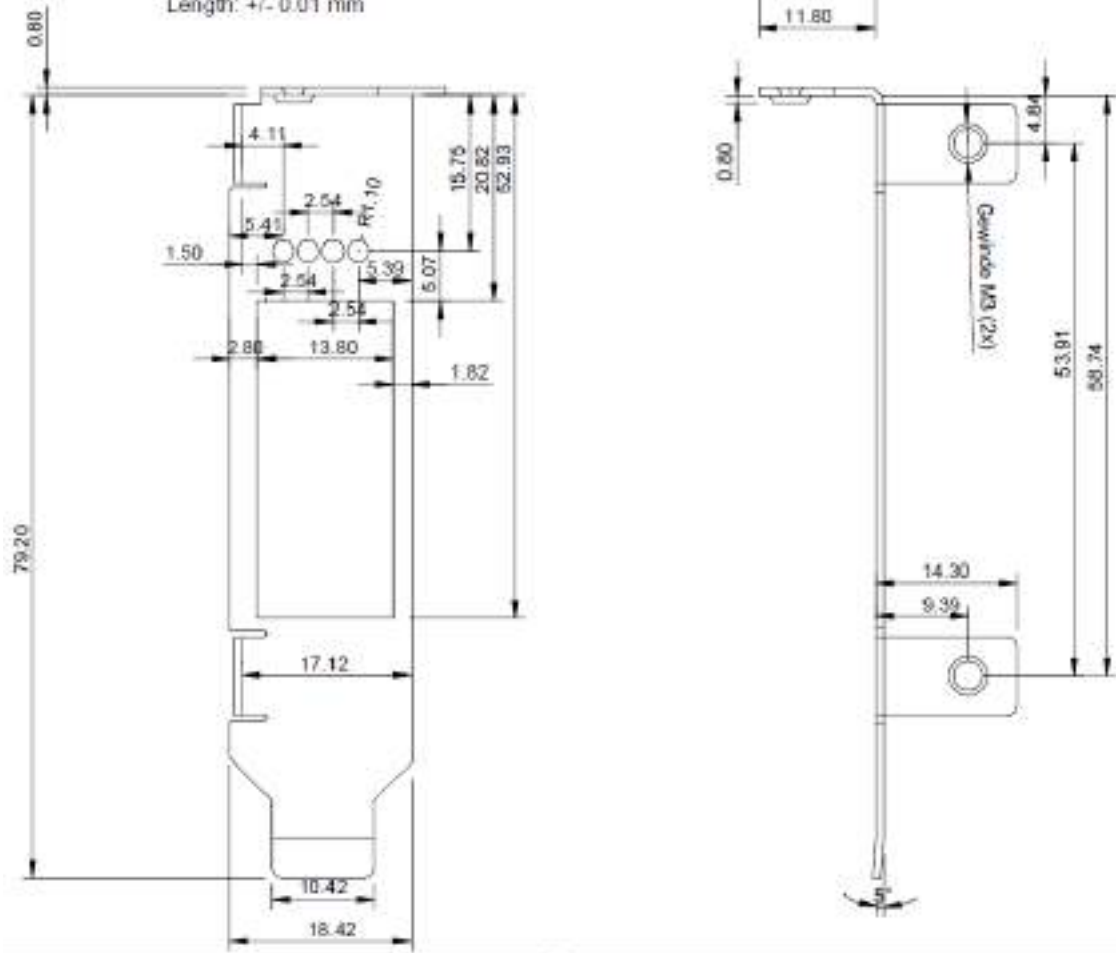

Figure 107: Dimensions Front Panel für CIFX 70E-CO, CIFX 70E-COMR

### 11.4.8 CIFX 70E-DN, CIFX 70E-DN\MR

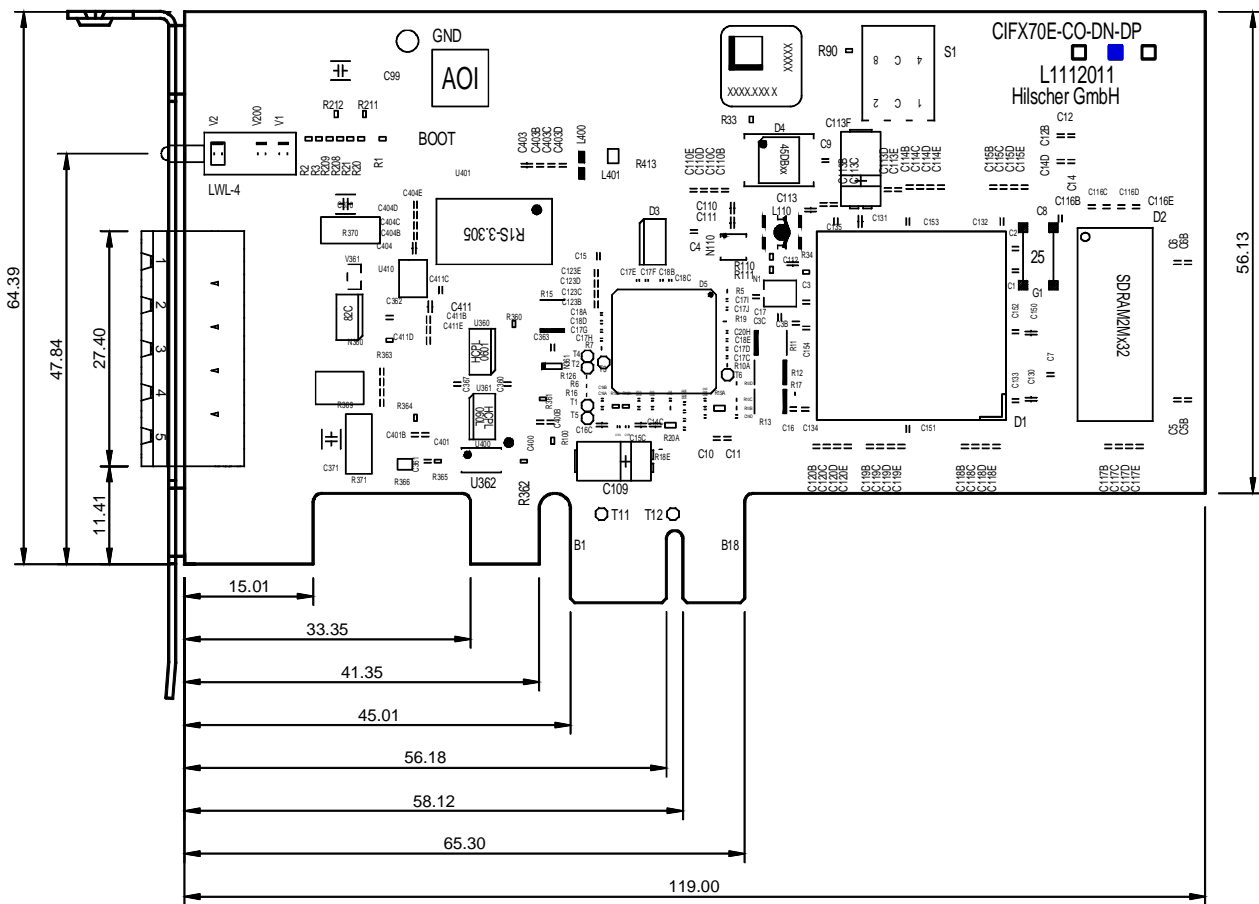

Figure 108: Dimensions CIFX 70E-DN and CIFX 70E-DN\MR (Hardware Rev. 1)

### 11.4.9 Front Panel CIFX 70E-DN, CIFX 70E-DNMR

Material:  
Edelstahl gebürstet 0,8 mm  
Toleranzen:  
Bohrdurchmesser: +/- 0,05 mm  
Längenmaß: +/- 0,01 mm

Material:  
Brushed stainless steel 0.8 mm  
Tolerances:  
Drilling diameter: +/- 0.05 mm  
Length: +/- 0.01 mm

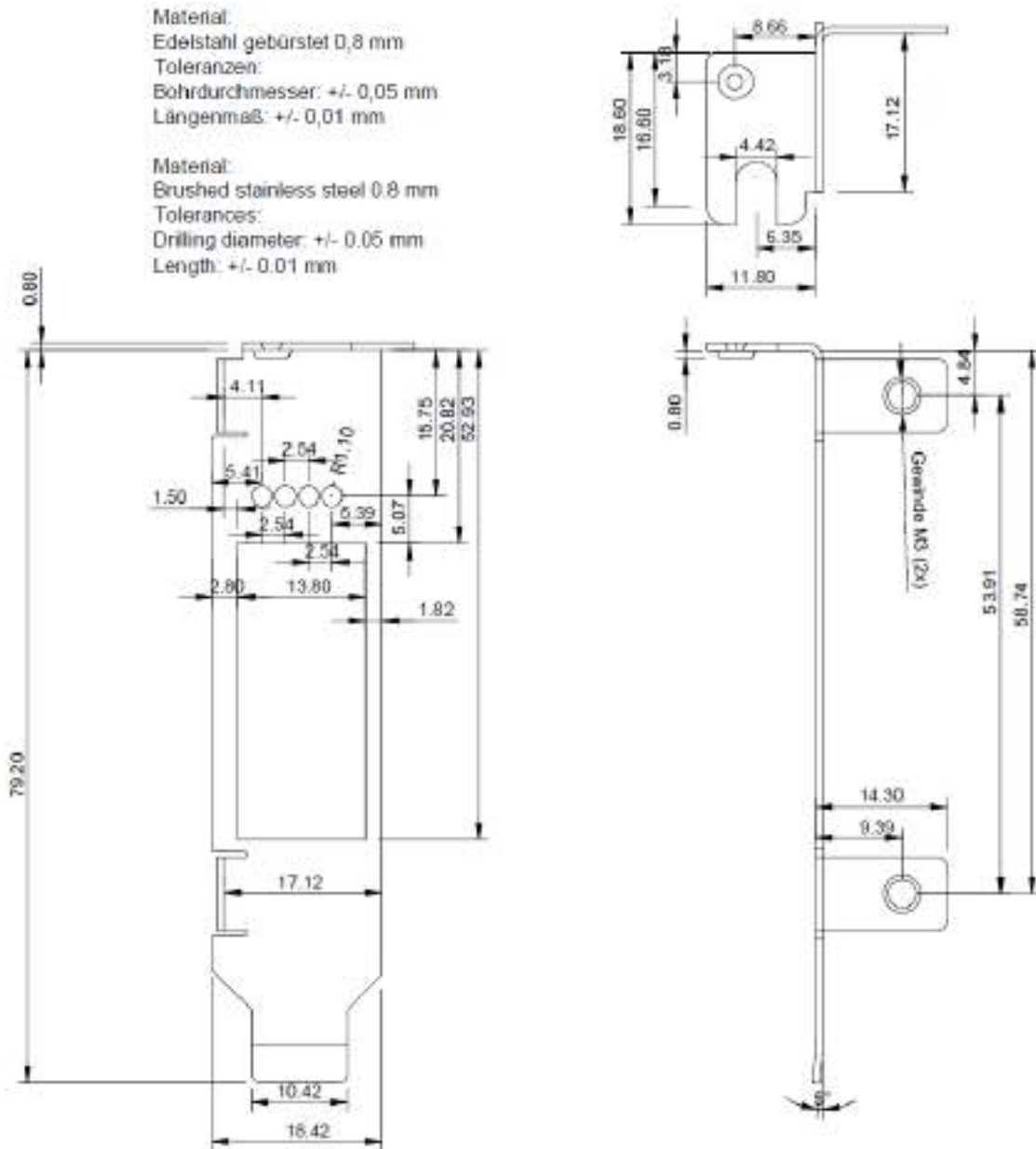

Figure 109: Dimensions Front Panel CIFX 70E-DN, CIFX 70E-DNMR

## 11.5 Notes on earlier Hardware Revisions

### 11.5.1 Failure in 10 MBit/s Half Duplex Mode and Workaround

The note is only valid for the PC cards cifX up to serial numbers indicated:

PC Cars cifX	Part No	up to Serial Number
CIFX 50-RE	1250.100	22414
CIFX 50E-RE	1251.100	20167

#### NOTICE

#### Failure of the Network Communication

- Do not operate hardware with the communication controllers netX 50, netX100 or netX 500 with the protocols Ethernet TCP/UDP/IP, EtherNet/IP or Modbus TCP at 10 MBit/s in half-duplex mode, otherwise failure of the network communication can occur.
- Use only switches or 10/100 MBit/s dual-speed hubs and ensure that the network operates at 100 MBit/s and in full-duplex mode.

#### Affected Hardware

Hardware with the communication controller netX 50, netX 100 or netX 500; netX/Internal PHYs.

#### When can this Failure occur?

When using standard Ethernet communication with 10 MBit/s half duplex mode, the PHY gets stuck in case of network collisions. Then no further network communication is possible. Only device power cycling allows Ethernet communication again.

This problem can only occur with Ethernet TCP/UDP IP, EtherNet/IP or Modbus TCP protocols when using hubs at 10 MBit/s. The issue described above is not applicable for protocols which use 100 MBit/s or full duplex mode.

#### Solution / Workaround:

Do not use 10 MBit/s-only hubs. Use either switches or 10/100 MBit/s Dual Speed hubs, to make sure the netX Ethernet ports are connected with 100 MBit/s or in full duplex mode.

This erratum is fixed with all components of the 'Y' charge (9 digit charge number shows 'Y' at position 5 (nnnnYnnnn)).

#### Reference

"Summary of 10BT problem on EthernetPHY",  
RenesasElectronics Europe, April 27, 2010



## 11.6 Disposal of Waste Electronic Equipment

According to the European Directive 2002/96/EG “Waste Electrical and Electronic Equipment (WEEE)”, waste electronic equipment may not be disposed of as household waste. As a consumer, you are legally obliged to dispose of all waste electronic equipment according to national and local regulations.



### Waste Electronic Equipment

- This product must not be treated as household waste.
- This product must be disposed of at a designated waste electronic equipment collecting point.

## 11.7 References

- [1] THE CIP NETWORKS LIBRARY, Volume 6, CompoNet Adaptation of CIP, Edition 1.4 November 2008
- [2] Data sheet MOD JACK – MJIM:  
<https://www.erni-x-press.com/de/downloads/zeichnungen/203313.pdf>
- [3] Design - Specification for VARAN Rev. 0.76, section 5.1.4 VARAN Splitter

References Protocol API Manuals
• AS-Interface Master Protocol API Manual, Revision 5, Hilscher GmbH 2016
• CANopen Master Protocol API Manual, Revision 16, Hilscher GmbH 2016
• CANopen Slave Protocol API Manual (V3), Revision 7, Hilscher GmbH 2016
• CC-Link IE Field Slave Protocol API, Revision 1, Hilscher GmbH 2018
• CC-Link IE Field-Basic Slave Protocol API, Revision 1, Hilscher GmbH 2018
• CC-Link Slave Protocol API Manual, Revision 11, Hilscher GmbH 2017
• DeviceNet Master Protocol API Manual, Revision 11, Hilscher GmbH 2016
• DeviceNet Slave Protocol API Manual, Revision 15, Hilscher GmbH 2016
• EtherCAT Master Protocol API Manual (V4), Revision 5, Hilscher GmbH 2017
• EtherCAT Master Protocol API Manual (V3), Revision 5, Hilscher GmbH 2013
• EtherCAT Slave Protocol API Manual (V4), Revision 10, Hilscher GmbH 2017
• EtherCAT Slave Protocol API Manual (V2), Revision 21, Hilscher GmbH 2013
• EtherNet/IP Scanner Protocol API Manual, Revision 14, Hilscher GmbH 2017
• EtherNet/IP Adapter Protocol API Manual, Revision 20, Hilscher GmbH 2017
• Open Modbus/TCP Protocol API Manual, Revision 10, Hilscher GmbH 2016
• POWERLINK-Controlled-Node/Slave Protocol API Manual (V3), Revision 8, Hilscher GmbH 2018
• POWERLINK-Controlled-Node/Slave Protocol API Manual (V2), Revision 13, Hilscher GmbH 2015
• PROFIBUS DP-Master Protocol API Manual, Revision 22, Hilscher GmbH 2017
• PROFIBUS DP-Slave Protocol API Manual, Revision 19, Hilscher GmbH 2017
• PROFIBUS MPI Protocol API Manual, Revision 4, Hilscher GmbH 2011
• PROFINET IO-Controller Protocol API Manual (V3), Revision 7, Hilscher GmbH 2017
• PROFINET IO-Controller Protocol API Manual (V2), Revision 19, Hilscher GmbH 2015
• PROFINET IO-Device Protocol API Manual (V4), Revision 2, Hilscher GmbH 2018
• PROFINET IO-Device Protocol API Manual (V3), Revision 18, Hilscher GmbH 2018
• Sercos Master Protocol API Manual, Revision 11, Hilscher GmbH 2013
• Sercos Slave Protocol API Manual (V3), Revision 17, Hilscher GmbH 2017
• VARAN Client Protocol API Manual, Revision 3, Hilscher GmbH 2013

Table 165: References Protocol API Manuals

References referring to the safety issues are listed separately in section *References Safety* on page 35. References referring to the Standard Bus Specifications for PCI and PCI Express are listed separately *References PCI Specifications* on page 145.

## 11.8 EtherCAT Summary over Vendor ID, Conformance test, Membership and Network Logo

### 11.8.1 Vendor ID

The communication interface product is shipped with Hilscher's secondary vendor ID, which has to be replaced by the Vendor ID of the company shipping end products with the integrated communication interface. End Users or Integrators may use the communication interface product without further modification if they re-distribute the interface product (e.g. PCI Interface card products) only as part of a machine or machine line or as spare part for such a machine. In case of questions, contact Hilscher and/or your nearest ETG representative. The ETG Vendor-ID policies apply.

### 11.8.2 Conformance

EtherCAT Devices have to conform to the EtherCAT specifications. The EtherCAT Conformance Test Policies apply, which can be obtained from the EtherCAT Technology Group (ETG, [www.ethercat.org](http://www.ethercat.org)).

Hilscher range of embedded network interface products are conformance tested for network compliance. This simplifies conformance testing of the end product and can be used as a reference for the end product as a statement of network conformance (when used with standard operational settings). It must however be clearly stated in the product documentation that this applies to the network interface and not to the complete product.

Conformance Certificates can be obtained by passing the conformance test in an official EtherCAT Conformance Test lab. Conformance Certificates are not mandatory, but may be required by the end user.

### 11.8.3 Certified Product vs. Certified Network Interface

The EtherCAT implementation may in certain cases allow one to modify the behavior of the EtherCAT network interface device in ways which are not in line with EtherCAT conformance requirements. For example, certain communication parameters are set by a software stack, in which case the actual software implementation in the device application determines whether or not the network interface can pass the EtherCAT conformance test. In such cases, conformance test of the end product must be passed to ensure that the implementation does not affect network compliance.

Generally, implementations of this kind require in-depth knowledge in the operating fundamentals of EtherCAT. To find out whether or not a certain type of implementation can pass conformance testing and requires such testing, contact EtherCAT Technology Group ("ETG", [www.ethercat.org](http://www.ethercat.org)) and/or your nearest EtherCAT conformance test centre. EtherCAT may allow the combination of an untested end product with a conformant network interface. Although this may in some cases make it possible to sell the end product without having to perform network conformance tests, this approach is generally not endorsed by Hilscher. In case of questions, contact Hilscher and/or your nearest ETG representative.

---

## 11.8.4 Membership and Network Logo

Generally, membership in the network organization and a valid Vendor-ID are prerequisites in order to be able to test the end product for conformance. This also applies to the use of the EtherCAT name and logo, which is covered by the ETG marking rules.

*Vendor ID Policy accepted by ETG Board of Directors, November 5, 2008*

## 11.9 List of Figures

Figure 1: System Overview cifX to update Firmware, Driver and Software	57
Figure 2: CIFX 50-RE* (from hardware rev. 3)	58
Figure 3: CIFX 50E-RE* (from hardware rev. 4), CIFX 50E-RE\ET* (from hardware rev. 1)	58
Figure 4: Front Plate for CIFX 50-RE, CIFX 50E-RE or CIFX 50E-RE\ET	59
Figure 5: CIFX 50E-CCIES* (Hardware revision 1)	60
Figure 6: Front Plate for CIFX 50E-CCIES	61
Figure 7: CIFX 50-DP (hardware revision 5)*	62
Figure 8: CIFX 50E-DP (hardware revision 5)*	62
Figure 9: Front Plate CIFX 50-DP or CIFX 50E-DP	63
Figure 10: CIFX 50-2DP (Hardware Revision 3)	64
Figure 11: CIFX 50E-2DP (Hardware Revision 1)	64
Figure 12: Front Plate CIFX 50-2DP, CIFX 50E-2DP	65
Figure 13: CIFX 50-2DP\CO (Hardware Revision 2)	66
Figure 14: CIFX 50E-2DP\CO (Hardware Revision 1)	66
Figure 15: Front Plate CIFX 50-2DP\CO, CIFX 50E-2DP\CO	67
Figure 16: CIFX 50-2DP\DN (Hardware Revision 1)	68
Figure 17: CIFX 50E-2DP\DN (Hardware Revision 1)	68
Figure 18: Front Plate CIFX 50-2DP\DN, CIFX 50E-2DP\DN	69
Figure 19: CIFX 50-CO (hardware revision 5)	70
Figure 20: CIFX 50E-CO (from hardware revision 4)	70
Figure 21: Front Plate for CIFX 50-CO or CIFX 50E-CO	71
Figure 22: CIFX 50-2CO (Hardware Revision 2)	72
Figure 23: CIFX 50E-2CO (Hardware Revision 1)	72
Figure 24: Front Plate CIFX 50-2CO, CIFX 50E-2CO	73
Figure 25: CIFX 50-2 CO\DN (Hardware Revision 1)	74
Figure 26: CIFX 50E-2 CO\DN (Hardware Revision 1)	74
Figure 27: Front Plate CIFX 50-2CO\DN, CIFX 50E-2 CO\DN	75
Figure 28: CIFX 50-DN (hardware revision 5)	76
Figure 29: CIFX 50E-DN (from hardware revision 4)	76
Figure 30: Front Plate CIFX 50-DN or CIFX 50E-DN	77
Figure 31: CIFX 50-2DN (Hardware Revision 2)	78
Figure 32: CIFX 50E-2DN (Hardware Revision 1)	78
Figure 33: Front Plate CIFX 50-2DN, CIFX 50E-2DN	79
Figure 34: CIFX 50-2ASM (hardware revision 2)	80
Figure 35: CIFX 50E-2ASM (from hardware revision 2)	80
Figure 36: Front Plate CIFX 50-2ASM	81
Figure 37: CIFX 50-CC (hardware revision 2)*	82
Figure 38: CIFX 50E-CC (hardware revision 4)*	82
Figure 39: Front Plate CIFX 50-CC or CIFX 50E-CC	83
Figure 40: CIFX 70E-RE* (Hardware revision 1)	84
Figure 41: CIFX 70E-RE\MR* (Hardware revision 1)	84
Figure 42: Front Plate for CIFX 70E-RE, CIFX 70E-RE\MR	85
Figure 43: CIFX 70E-CCIES* (Hardware revision 1)	86
Figure 44: Front Plate for CIFX 70E-CCIES	87
Figure 45: CIFX 100EH-RE\CUBE*	88
Figure 46: Front Plate CIFX 100EH-RE\CUBE	88
Figure 47: CIFX 70E-DP (Hardware revision 1)	89
Figure 48: CIFX 70E-DP\MR (Hardware revision 1)	89
Figure 49: Front Plate CIFX 70E-DP, CIFX 70E-DP\MR	90
Figure 50: CIFX 70E-CO (Hardware revision 1)	91
Figure 51: CIFX 70E-CO\MR (Hardware revision 1)	91

Figure 52: Front Plate CIFS 70E-CO, CIFS 70E-COMR	92
Figure 53: CIFS 70E-DN (Hardware revision 1)	93
Figure 54: CIFS 70E-DNMR (Hardware revision 1)	93
Figure 55: Front Plate CIFS 70E-DN, CIFS 70E-DNMR	94
Figure 56: Front Plate Stickers for CIFS 50-RE, CIFS 50E-RE or CIFS 50E-RE\ET	96
Figure 57: Front Plate Stickers for CIFS 70E-RE, CIFS 70E-RE\MR	98
Figure 58: Front Plate Stickers for CIFS 100EH-RE\CUBE	98
Figure 59: Ethernet Pin Assignment at the RJ45 Socket for cifX or AIFS	135
Figure 60: Ethernet Pin Assignment at the RJ45 Socket (1000 MBit/s)	136
Figure 61: PROFIBUS Interface (DSub female connector, 9 pin), X400	138
Figure 62: CANopen Interface (DSub male connector, 9 pin), X400	138
Figure 63: DeviceNet Interface (CombiCon male Connector, 5 pin), X360	139
Figure 64: AS-Interface Interface (CombiCon male Connector, 2 pin)	139
Figure 65: CC-Link Interface (CombiCon male Connector, 5 pin)	140
Figure 66: Example 2D Label (mini sticker on the right)	220
Figure 67: Dimensions CIFS 50-RE (from Hardware Rev.3)	221
Figure 68: Dimensions CIFS 50E-RE (from Hardware Rev.4), CIFS 50E-RE\ET (from Hardware Rev.1)	222
Figure 69: Dimensions Front Panel CIFS 50-RE, CIFS 50E-RE or CIFS 50E-RE\ET	223
Figure 70: Dimensions CIFS 50E-CCIES (from Hardware Rev.1)	224
Figure 71: Dimensions Front Panel CIFS 50E-CCIES	225
Figure 72: Dimensions CIFS 50-DP (Hardware Rev.5)	226
Figure 73: Dimensions CIFS 50E-DP (Hardware Rev.6)	227
Figure 74: Dimensions Front Panel CIFS 50-DP or CIFS 50E-DP	228
Figure 75: Dimensions CIFS 50-CO (Hardware Rev.5)	229
Figure 76: Dimensions CIFS 50E-CO (from Hardware Rev.4)	230
Figure 77: Dimensions Front Panel für CIFS 50-CO or CIFS 50E-CO	231
Figure 78: Dimensions CIFS 50-DN (Hardware Rev.5)	232
Figure 79: Dimensions CIFS 50E-DN (from Hardware Rev.4)	233
Figure 80: Dimensions Front Panel CIFS 50-DN or CIFS 50E-DN	234
Figure 81: Dimensions CIFS 50-CC (Hardware Rev.2)	235
Figure 82: Dimensions CIFS 50E-CC (from Hardware Rev.4)	236
Figure 83: Dimensions Front Panel CIFS 50-CC or CIFS 50E-CC	237
Figure 84: Dimensions CIFS 50-2DP (Hardware Rev.3)	238
Figure 85: Dimensions CIFS 50E-2DP (Hardware Rev.1)	239
Figure 86: Dimensions CIFS 50-2DP\CO (Hardware Rev.2)	240
Figure 87: Dimensions CIFS 50E-2DP\CO (Hardware Rev. 1)	241
Figure 88: Dimensions CIFS 50-2DP\DN (Hardware Rev.1)	242
Figure 89: Dimensions CIFS 50E-2DP\DN (Hardware Rev. 1)	243
Figure 90: Dimensions CIFS 50-2CO (Hardware Rev.2)	244
Figure 91: Dimensions CIFS 50E-2CO (Hardware-Rev. 1)	245
Figure 92: Dimensions CIFS 50-2CO\DN (Hardware Rev.1)	246
Figure 93: Dimensions CIFS 50E-2CO\DN (Hardware Rev. 1)	247
Figure 94: Dimensions CIFS 50-2DN (Hardware Rev.2)	248
Figure 95: Dimensions CIFS 50E-2DN (Hardware Rev. 1)	249
Figure 96: Dimensions Front Panel CIFS 50-2FB	250
Figure 97: Dimensions CIFS 50-2ASM (Hardware Rev.2)	251
Figure 98: Dimensions CIFS 50E-2ASM (from Hardware Rev.2)	252
Figure 99: Dimensions Front Panel CIFS 50-2ASM, CIFS 50E-2ASM	253
Figure 100: Dimensions CIFS 70E-RE and CIFS 70E-RE\MR (Hardware Rev.1)	254
Figure 101: Dimensions Front Panel für CIFS 70E-RE, CIFS 70E-RE\MR	255
Figure 102: Dimensions CIFS 70E-CCIES (from Hardware Rev. 1)	256
Figure 103: Dimensions Front Panel CIFS 70E-CCIES	257
Figure 104: Dimensions CIFS 70E-DP and CIFS 70E-DP\MR (Hardware Rev.1)	258

Figure 105: Blende für CIFX 70E-DP, CIFX 70E-DP\MR	259
Figure 106: Dimensions CIFX 70E-CO and CIFX 70E-CO\MR (Hardware Rev.1)	260
Figure 107: Dimensions Front Panel für CIFX 70E-CO, CIFX 70E-CO\MR	261
Figure 108: Dimensions CIFX 70E-DN and CIFX 70E-DN\MR (Hardware Rev.1)	262
Figure 109: Dimensions Front Panel CIFX 70E-DN, CIFX 70E-DN\MR	263

## 11.10 List of Tables

Table 1: List of Revisions	9
Table 2: Reference on Hardware PC Cards cifX	11
Table 3: Reference on Driver and Software	11
Table 4: Reference on Firmware (for 1 Channel Systems), **Outdated versions	12
Table 5: Reference on Firmware (for 2 Channel Systems)	12
Table 6: PROFINET IO-Controller Firmware V2 and V3 on the Product DVD	16
Table 7: PROFINET IO-Device Firmware Version 3.4 and 3.13, Header, GSDML and Protocol API Manual	17
Table 8: EtherCAT Master Firmware V3 and V4 on the Product DVD	18
Table 9: EtherCAT-Slave Firmware Version 2.5 and 4.7, Header, XML and Protocol API Manual	19
Table 10: POWERLINK Controlled Node Firmware V2 and V3 on the Product DVD	21
Table 11: Device Description Files for PC Cards cifX	22
Table 12: PC Cards cifX and the Real-Time Ethernet or Fieldbus Systems realized thereby	28
Table 13: Signal Words	35
Table 14: Safety Signs	35
Table 15: PC Cards PCI CIFX 50-XX	36
Table 16: PC Cards PCI (2 Channels) CIFX 50-2XX, CIFX 50-2XX\XX	37
Table 17: PC Cards PCI Express CIFX 50E-XX, CIFX 70E-XX	37
Table 18: PC Cards PCI Express (2 Channels) CIFX 50E-2XX, CIFX 50E-2XX\XX	38
Table 19: Firmware Versions for the Function Slot Number (Card ID), (for 1 Channel Systems)	39
Table 20: Firmware Versions for the Function Slot Number (Card ID) (for 2 Channel Systems)	40
Table 21: Versions Driver, Bootloader and SYCON.net for Function Slot Number (Card ID)	40
Table 22: Firmware Versions for the DMA Mode (for 1 Channel Systems)	41
Table 23: Firmware Versions for the DMA Mode (for 2 Channel Systems)	42
Table 24: Versions Driver and SYCON.net for the DMA Mode	42
Table 25: Slot for the PC Cards cifX PCI, PCIe and Low Profile PCIe	43
Table 26: Requirements Power Supply and Host Interface for PC Cards cifX PCI, PCIe Low Profile PCIe	44
Table 27: Requirements to operate PC Cards cifX properly	45
Table 28: Steps for the Software and Hardware Installation, the Configuration and for the Diagnosis of a PC Card cifX (Master and Slave)	52
Table 29: Notes for the Configuration of the Master Device	54
Table 30: Device Names in SYCON.net by Communication Protocol	56
Table 31: Assignment of the LEDs to the Channels	83
Table 32: LED Labeling depending of the loaded Firmware	96
Table 33: Fix Front Plate Sticker at the CIFX 70E-RE, CIFX 70E-RE\MR or CIFX 100EH-RE\CUBE	97
Table 34: LED Labeling depending of the loaded Firmware, CIFX 70E-RE, CIFX 70E-RE\MR	98
Table 35: Overview LEDs Real-Time Ethernet Systems	102
Table 36: LED Names	102
Table 37: Overview LEDs by Fieldbus System for 1 Channel Devices	103
Table 38: Overview LEDs by Fieldbus System for 2 Channel Devices	103
Table 39: LED Names	103
Table 40: System Status LED States	104
Table 41: LED states for the CC-Link IE Field Basic Slave	105
Table 42: LED state definitions for the CC-Link IE Field Basic Slave protocol	105

Table 43: LED states for the CC-Link IE Field Slave protocol	106
Table 44: LED Names CC-Link IE Field Slave protocol	106
Table 45: LED states for the EtherCAT Master protocol	107
Table 46: LED state definitions for the EtherCAT Master protocol	107
Table 47: LED states for the EtherCAT Master protocol	108
Table 48: LED state definitions for the EtherCAT Master protocol	109
Table 49: LED states for the EtherCAT Slave protocol	110
Table 50: LED state definitions for the EtherCAT Slave protocol	110
Table 51: LED states for the EtherNet/IP Scanner protocol	112
Table 52: LED state definitions for the EtherNet/IP Scanner protocol	112
Table 53: LED states for the EtherNet/IP Adapter protocol	114
Table 54: LED state definitions for the EtherNet/IP Adapter protocol	114
Table 55: LED states for the OpenModbusTCP protocol	115
Table 56: LED state definitions for the OpenModbusTCP protocol	115
Table 57: LED states for the POWERLINK Controlled Node protocol	116
Table 58: LED state definitions for the POWERLINK Controlled Node protocol	116
Table 59: LED states for the PROFINET IO-Controller protocol	117
Table 60: LED state definitions for the PROFINET IO-Controller protocol	117
Table 61: PROFINET IO Controller, SYS, COM0 and COM1 LEDs states	118
Table 62: PROFINET IO Controller, Ethernet LEDs states	119
Table 63: PROFINET IO Controller, LEDs states definitions	119
Table 64: LED states for the PROFINET IO-Device protocol	120
Table 65: LED state definitions for the PROFINET IO-Device protocol	120
Table 66: LED states for the Sercos Master protocol	121
Table 67: LED state definitions for the Sercos Master protocol	122
Table 68: LED state definitions for the Sercos Slave protocol	123
Table 69: LED state definitions for the Sercos Slave protocol	124
Table 70: LED-Zustände für das VARAN-Client-Protokoll	125
Table 71: Definitionen der LED-Zustände für das VARAN-Client-Protokoll	125
Table 72: LED states for the PROFIBUS DP Master protocol	126
Table 73: LED state definitions for the PROFIBUS DP Master protocol	126
Table 74: LED states for the PROFIBUS DP Slave protocol	127
Table 75: LED state definitions for the PROFIBUS DP Slave protocol	127
Table 76: LED states for the PROFIBUS MPI protocol	128
Table 77: LED state definitions for the PROFIBUS MPI protocol	128
Table 78: LED states for the CANopen Master protocol	129
Table 79: LED state definitions for the CANopen Master protocol	129
Table 80: States of the CAN LED for the CANopen Slave protocol – 1 Communication Status LED (current Hardware Revision)	130
Table 81: LED state definitions for the CANopen Slave protocol	130
Table 82: LED states for the DeviceNet Master protocol	131
Table 83: LED state definitions for the DeviceNet Master protocol	131
Table 84: LED states for the DeviceNet Slave protocol	132
Table 85: LED state definitions for the DeviceNet Slave protocol	132
Table 86: LEDs states for the AS-Interface Master protocol	133
Table 87: LED state definitions for the AS-Interface Master protocol	133
Table 88: LED states for the CC-Link Slave protocol	134
Table 89: Ethernet Pin Assignment at the RJ45 Socket for cifX or AIFX	135
Table 90: Ethernet Pin Assignment at the RJ45 Socket (1000 MBit/s)	136
Table 91: Ethernet Connection Data	137
Table 92: Use of Hubs and Switches	137
Table 93: PROFIBUS Interface, X400	138
Table 94: CANopen Interface, X400	138

Table 95: DeviceNet Interface, X360	139
Table 96: AS-Interface Interface	139
Table 97: CC-Link Interface	140
Table 98: Rotary Switch for Slot Number (Card ID), S1	141
Table 99: Rotary Switch Slot Number (Card ID) PC Cards cifX Low Profile PCI Express	142
Table 100: Pin Assignment for SYNC Connector, X51	143
Table 101: Pin Assignment for SYNC Connector, J1	143
Table 102: SYNC Connector: SYNC Signal, Connector, Max. Cable Length	144
Table 103: Meaning of the SYNC Signals for each Protocol	144
Table 104: Pin Assignment at the PCI Bus	145
Table 105: References PCI Specifications	145
Table 106: Pin Assignment for PCI Express-Bus CIFX 100EH-RE\CUBE	146
Table 107: Technical Data CIFX 50-RE	148
Table 108: Technical Data CIFX 50E-RE, CIFX 50E-RE\ET	150
Table 109: Technical Data CIFX 50E-CCIES, CIFX 70E-CCIES	152
Table 110: Technical Data CIFX 50-DP	154
Table 111: Technical Data CIFX 50E-DP	155
Table 112: Technical Data CIFX 50-CO	157
Table 113: Technical Data CIFX 50E-CO	158
Table 114: Technical Data CIFX 50-DN	160
Table 115: Technical Data CIFX 50E-DN	161
Table 116: Technical Data CIFX 50-CC	162
Table 117: Technical Data CIFX 50E-CC	164
Table 118: Technical Data CIFX 50-2DP	165
Table 119: Technical Data CIFX 50E-DP	167
Table 120: Technical Data CIFX 50-2DP\CO	169
Table 121: Technical Data CIFX 50E-2DP\CO	171
Table 122: Technical Data CIFX 50-2DP\DN	172
Table 123: Technical Data CIFX 50-2DP\DN	174
Table 124: Technical Data CIFX 50-2CO	175
Table 125: Technical Data CIFX 50E-2CO	177
Table 126: Technical Data CIFX 50-2CO\DN	178
Table 127: Technical Data CIFX 50E-2CO\DN	180
Table 128: Technical Data CIFX 50-2DN	181
Table 129: Technical Data CIFX 50E-2DN	183
Table 130: Technical Data CIFX 50-2ASM	184
Table 131: Technical Data CIFX 50E-2ASM	185
Table 132: Technical Data CIFX 70E-RE, CIFX 70E-RE\MR	187
Table 133: Technical Data CIFX 100EH-RE\CUBE	190
Table 134: Technical Data CIFX 70E-DP, CIFX 70E-DP\MR	191
Table 135: Technical Data CIFX 70E-CO, CIFX 70E-CO\MR	192
Table 136: Technical Data CIFX 70E-DN, CIFX 70E-DN\MR	194
Table 137: PCI IDs PC Cards cifX on the PCI Bus	195
Table 138: Supported / not supported PCI Bus Commands	195
Table 139: Technical data CC-Link IE Field Basic Slave protocol	196
Table 140: Technical data CC-Link IE Field Slave protocol	196
Table 141: Technical Data EtherCAT Master Protocol	197
Table 142: Technical Data EtherCAT Master Protocol	198
Table 143: Technical Data EtherCAT Slave Protocol	199
Table 144: Technical Data EtherNet/IP Scanner Protocol	200
Table 145: Technical Data EtherNet/IP Adapter Protocol	201
Table 146: Technical Data Open Modbus/TCP Protocol	202
Table 147: Technical Data POWERLINK Controlled Node Protocol	203



---

Table 148: Technical Data POWERLINK Controlled Node Protocol	203
Table 149: Technical Data PROFINET IO RT Controller Protocol	205
Table 150: Technical Data PROFINET IO Controller Protocol	206
Table 151: Technical Data PROFINET IO RT IRT Device Protocol	207
Table 152: Technical Data PROFINET IO RT IRT Device Protocol	208
Table 153: Technical Data Sercos Master Protocol	208
Table 154: Technical Data Sercos Slave Protocol	209
Table 155: Technical Data VARAN Client Protocol	210
Table 156: Technical Data PROFIBUS DP Master Protocol	211
Table 157: Technical Data PROFIBUS DP Slave Protocol	212
Table 158: Technical Data PROFIBUS-MPI Protocol	213
Table 159: Technical Data CANopen Master Protocol	214
Table 160: Technical Data CANopen Slave Protocol	215
Table 161: Technical Data DeviceNet Master Protocol	216
Table 162: Technical Data DeviceNet Slave Protocol	217
Table 163: Technical Data AS-Interface Master Protocol	218
Table 164: Technical Data CC-Link-Slave-Protocol	219
Table 165: References Protocol API Manuals	265

## 11.11 Glossary

### 10-Base T

Standard for communication on Ethernet over twisted pair lines with RJ45 connectors and a [Baud rate](#) of 10 MBit/s (according to the IEEE 802.3 specification).

### 100-Base TX

Standard for communication on Ethernet over unshielded twisted pair lines with RJ45 connectors and a [Baud rate](#) of 100 MBit/s according to the IEEE 802. Specification

### 1000BASE-T

Standard for communication on Ethernet over unshielded twisted pair lines with RJ45 connectors and a [Baud rate](#) of 1 GBit/s according to the IEEE 802.3ab Specification.

### Auto-Crossover

Auto-Crossover is a feature of an interface: An interface with Auto-Crossover capability will automatically detect and correct if the data lines have been exchanged vice versa.

### Auto-Negotiation

Auto-Negotiation is a feature of an interface: An interface with Auto-Negotiation will automatically determine a set of correct communication parameters.

### Baud rate

Data transmission speed of a communication channel or interface.

### Boot loader

Program loading the firmware into the memory of a device in order to be executed.

### CC-Link IE Field

Communication system for industrial Ethernet designed and developed by Mitsubishi Electric Corporation, Tokyo, Japan, for high data throughput based on Gigabit

### CC-Link IE Field Master

Station in the CC-Link IE Field network controlling parameters and managing cyclic communication

### CC-Link IE Field Slave

Station in the CC-Link IE Field network communicating with a master station

### CC-Link IE Field Basic

Communication system for Industrial Ethernet designed and developed by Mitsubishi Electric Corporation, Tokyo, Japan, providing CC-Link IE Field with a speed of 100 Mbit/s based on TCP/IP

**CC-Link IE Field Basic Master**

Station in the CC-Link IE Field Basic network controlling parameters and managing cyclic communication

**CC-Link IE Field Basic Slave**

Station in the CC-Link IE Field Basic network communicating with a master station

**Ch0, Ch1 ...**

Within the configuration software SYCON.net the communication channels are named ,Ch0', Ch1' ....

For the Real-Time-Ethernet devices cifX, comX and netJACK and the Real-Time Ethernet protocols used with it, the following shall apply:

**'Ch0' in SYCON.net:** Both ports of the Ethernet RJ45 connector CH0 and CH1 are assigned always to channel 0 in SYCON.net.

**'Ch1' in SYCON.net:** Depending on the firmware channel 1 in SYCON.net can be used as an additional communication channel.

**CH0, CH1 (Ch0, Ch1)**

Names for the ports of an Ethernet RJ45 socket with two Ethernet channels.

CH0 stands for Ethernet channel 0.

CH1 stands for Ethernet channel 1.

**cifX**

Communication InterFace based on netX

**cifX TCP/IP Server**

*cifX TCP Server.exe*

Program for the remote diagnostics via Ethernet.

Name: **cifX TCP/IP Server for SYCON.net**

User Interface: **TCP/IP Server for cifX**

**Coil**

A coil is a single bit in the memory that can be accessed using Modbus: read or write access with FC 1, 5, 15. Depending on the used Modbus function code a single coil or several coils lying in succession can be accessed.

**CSP**

electronic device data sheet, required for each CC-Link device

**CSPP**

(CSP+) Control and communication system profile, respectively specification and device description file that contains and provides the necessary data on CC-Link compatible devices for commissioning, operation and maintenance.

---

**Device Description File**

A file containing configuration information about a device being a part of a network that can be read out by masters for system configuration. Device Description Files use various formats which depend on the communication system.

**DHCP**

Dynamic Host Configuration Protocol

This is a protocol simplifying the configuration of IP networks by automatically assigning IP addresses.

**Discrete Input**

A "Discrete Input" (as defined in the Modbus terminology) is a single bit in the memory which can be accessed using Modbus (read with FC 2).

**DP**

Decentral Periphery

**DPM**

Dual-Port Memory

**EDS**

Electronic Data Sheet

**EDS file**

A special kind of Device Description File used for example by EtherNet/IP.

**ET**

Extended Temperature Range (Operating Temperature)

PC cards cifX with the addition of "ET" at the end of the part name can be used in an extended operating temperature range. Details to the operating temperature range are given in the technical data to the respective card.

**EtherCAT**

A communication system for industrial Ethernet designed and developed by Beckhoff Automation GmbH.

**Ethernet**

A networking technology used both for office and industrial communication via electrical or optical connections. It has been developed and specified by the Intel, DEC and XEROX. It provides data transmission with collision control and allows various protocols. As Ethernet is not necessarily capable for real-time application, various real-time extensions have been developed.

**EtherNet/IP**

A communication system for industrial Ethernet designed and developed by Rockwell. It partly uses the CIP (Common Industrial Protocol).

**EtherNet/IP Scanner**

A Scanner exchanges real-time I/O data with Adapters and Scanners. This type of node can respond to connection requests and can also initiate connections on its own.

**EtherNet/IP Adapter**

An Adapter emulates functions provided by traditional rack-adapter products. This type of node exchanges real-time I/O data with a Scanner Class product. It does not initiate connections on its own.

**Ethernet POWERLINK**

A communication system for industrial Ethernet designed and developed by B&R. It partly uses CANopen technologies.

**FDL**

Fieldbus Data Link defines the PROFIBUS communication on layer 2, identical for DP and FMS

**Firmware**

Software running inside a device providing the basic functionality of this device. It can be updated by a firmware download.

**Full duplex**

Full duplex denominates a telecommunication system between two communication partners which allows simultaneous communication in both directions is called a full-duplex telecommunication system. At such a system, it will be possible to transmit data even if currently data are received. Full-duplex is the opposite of Half\_duplex.

**Function code**

A function code (FC) is a standardized method to access, i. e. read or write on coils (Bits) or registers via Modbus.

Modbus function codes are elements of Modbus request/reply telegrams.

**GSD**

Generic Station Description, Device description file

**GSD file**

A special kind of Device Description File used by PROFIBUS (GSD = Generic Station Description).

**GSDML**

Generic Station Description Markup Language

XML based device description file.

**GSDML file**

A special kind of XML-based Device Description File used by PROFINET.

## Half duplex

Half duplex denominates a telecommunication system between two communication partners which does not allow simultaneous, but alternating, communication in both directions is called a half-duplex telecommunication system. At such a system, receiving data inhibits the transmission of data. Half-duplex is the opposite of `_Full_duplex`.

## Hub

A network component connecting multiple communication partners with each other. A hub does not provide own intelligence, thus it does not analyze the data traffic and sends received data to all connected communication partners. A hub can be used for setting up a star topology.

## Industrial Ethernet

See Real-Time Ethernet

## IP

Internet Protocol.

IP belongs to the TCP/IP family of protocols and is defined in RFC791. It is based on layer 3 of the ISO/OSI 7 layer model of networking.

It is a connectionless protocol, i.e. you do not need to open a connection to a computer before sending an IP data packet to it. Therefore IP is not able to guarantee that the IP data packets really arrive at the recipient. On IP level neither the correctness of data nor the consistence and completeness are checked.

IP defines special addressing mechanisms, see IP Address.

## IP Address

Address within IP (the Internet Protocol, part of TCP/IP).

An IP address is an address identifying a device or a computer within a network using the IP protocol. IP addresses are defined as a 32 bit number. Usually, for ease of notation the IP address is divided into four 8 bit numbers which are represented in decimal notation and separated by points:

a.b.c.d

where a.b.c.d are each integer values between 0 and 255.

Example: 192.168.30.15

However, not all combinations are allowed, some are reserved for special purposes.

The IP address 0.0.0.0 is defined as invalid.

## MAC-ID

MAC = Media Access Control

*Definition for Ethernet:*

A MAC-ID is on delivery a unique (physical) Ethernet address of the device.

MAC-IDs are defined as a 48 bit number. Usually, for ease of notation the MAC-ID address is divided into six 8 bit numbers which are represented in hexadecimal notation and separated by "minus"-signs (-):

A-B-C-D-E-F

where A-B-C-D-E-F are each integer values between 0 and 255.

Example: 00-02-A2-20-91-18

*Definition for DeviceNet:* The MAC-ID is the network address of the device. The network address of a device serves to distinguish itself on a DeviceNet fieldbus system from any other device or Slave on this network. This should be a unique number for each device. A valid MAC-ID address is within a range of 0 to 63 and can be re-entered and changed in the MAC-ID box in the Device Configuration Dialog.

## Master

Type of device that initiates and controls the communication on the bus

## Modbus Data Model

The data model distinguishes four basic types of data areas:

- Discrete Inputs (inputs) = FC 2 (Read)
- coils (outputs) = FC 1, 5, 15 (Write and Read back)
- Input register (input data) = FC 4 (Read)
- Holding register (output data) = FC 3, 6, 16, 23 (Write and Read back).

It should be noted, however, that depending on the device manufacturer and device type:

- the data area in the device may be present or not,
- and two data areas can be combined into one data region. For example, discrete inputs and input registers can be a common data area, which can be accessed with read-FC 2 and FC 4.
- Further FC 1 and FC 3 are used instead of reading back the inputs to read the outputs.

## MPI

Multi Point Interface

The MPI is a proprietary interface of the SIMATIC® S7® series of PLCs. It is compatible to PROFIBUS and based on RS-485. It usually works with a transmission rate of 187.5 kBaud.

## netX

networX on chip, Hilscher network communication controllers

## netX Configuration Tool

The netX Configuration Tool allows users to operate cifX or netX based devices in different networks. Its graphical user interface serves as a configuration tool for the installation, configuration and diagnosis of the devices.

## Object Dictionary

An object dictionary is a storage area for device parameter data structures. It is accessed in standardized manner.

**Open Modbus/TCP**

A communication system for Industrial Ethernet designed and developed by Schneider Automation and maintained by the Modbus-IDA organization based on the Modbus protocols for serial communication.

**PCB**

Printed Circuit Board, (printed = machine-made) circuit board

**PCIe**

Abbreviation for PCI Express

**PC Card cifX**

Communication Interfaces of the cifX product family of Hilscher on the basis of the communication controller netX 100:

for the Real-Time Ethernet systems

- CC-Link IE Field
- CC-Link IE Field Basic
- EtherCAT
- EtherNet/IP
- Open-Modbus/TCP
- POWERLINK
- PROFINET IO
- Sercos
- VARAN

and for the fieldbus systems

- PROFIBUS DP
- PROFIBUS MPI
- CANopen
- DeviceNet
- AS-Interface
- CompoNet
- CC-Link

as Communication Interface netX with PCI Bus

- PCI (CIFX 50),
- PCI Express (CIFX 50E),
- Low Profile PCI Express (CIFX 70E, CIFX 100EH-RE\CUBE\*),
- Compact PCI (CIFX80),
- Mini PCI (CIFX90),
- Mini PCI Express (CIFX 90E),
- PCI-104 (CIFX 104C)

and as Communication Interface netX with ISA Bus

- PC/104 (CIFX 104).

\*only Real-Time Ethernet

**PROFINET**

A communication system for Industrial Ethernet designed and developed by PROFIBUS & PROFINET International (PI). It uses some mechanisms similar to those of the PROFIBUS field bus.

**PROFINET IO Controller**

A PROFINET control unit responsible for the defined run-up of an I/O subsystem and the cyclic or acyclic data exchange.



**PROFINET IO Device**

A PROFINET field device that cyclically receives output data from its IO-Controller and responds with its input data.

**RE**

RE stands for Real-Time Ethernet

**Real-Time Ethernet**

Real-Time Ethernet (Industrial Ethernet) is an extension of the Ethernet networking technology for industrial purposes with very good real-time features and performance. There is a variety of different Real-Time Ethernet systems on the market which are incompatible with each other. The most important systems of these are

- CC-Link IE Field
- CC-Link IE Field Basic
- EtherCAT
- EtherNet/IP
- Ethernet POWERLINK
- Open Modbus/TCP
- PROFINET
- Sercos
- VARAN

**Register**

A register is a 16-bit wide storage area for data which can be accessed and addressed as a unit by some of the Modbus Function Codes.

Depending on the used Modbus function code a single register or multiple registers sequentially located can be accessed.

Modbus differs Input Registers (FC 4) and Holding Registers (FC 3, 6, 16, 23).

**Remanent**

Remanent memory holds its data even after power-off, for instance flash memory is remanent. It is also called non-volatile memory.

**RJ45**

A connector type often used for Ethernet connection. It has been standardized by the Federal Communications Commission of the USA (FCC).

**Sercos**

A communication system for industrial Ethernet designed and developed by Bosch-Rexroth and supported by Sercos International.

**Slave**

Type of device that is configured by the Master and which then performs the communication

**Switch**

A network component connecting multiple communication partners (or even entire branches of a network) with each other. A switch is an intelligent network component which analyzes network traffic in order to decide on its own. For the connected communication partners a switch behaves transparently.

**SYCON.net**

FDT/DTM based configuration and diagnosis software by Hilscher

**SYNC**

Synchronization cycle of the master

**TCP/IP**

Transport Control Protocol/Internet Protocol connection-orientated, secure transfer protocol as basis for the Internet-protocols

**UCMM**

Unconnected Message Manager

**VARAN**

**V**ersatile **A**utomation **R**andom **A**ccess **N**etwork

A communication system for industrial Ethernet based on the DIAS-BUS developed by Sigmatek. The system is supported by the VARAN-BUS-NUTZERORGANISATION (VNO).

**Watchdog Timer**

A watchdog timer provides an internal supervision mechanism of a communication system. It supervises that an important event happens within a given timeframe (the watchdog time which can be adjusted accordingly, for instance by a parameter in the warmstart message) and causes an alarm otherwise (usually this is accomplished by changing the operational state of the communication system to a more safe state).

**X1, X2, X3, X4 ...**

serve as position names on the circuit board but can also have other or extended meanings

**X1, X2**

(names on the front panel) ... serve for PC cards cifX PCI and PCI Express with 2 channels to identify the respective communication channel:  
X1 stands for fieldbus 1 (channel X1; in SYCON.net assigned to *Ch0*).  
X2 stands for fieldbus 2 (channel X2; in SYCON.net assigned to *Ch1*).

**XDD file**

A special kind of Device Description file used by Ethernet POWERLINK.

**XML**

XML means Extended Markup Language. It is a symbolic language for structuring data systematically. XML is standard maintained by the W3C

---

(World-wide web consortium). Device Description Files often use XML-based formats for storing the device-related data appropriately.

## 11.12 Contacts

### Headquarters

#### Germany

Hilscher Gesellschaft für  
Systemautomation mbH  
Rheinstrasse 15  
65795 Hattersheim  
Phone: +49 (0) 6190 9907-0  
Fax: +49 (0) 6190 9907-50  
E-Mail: [info@hilscher.com](mailto:info@hilscher.com)

#### Support

Phone: +49 (0) 6190 9907-99  
E-Mail: [de.support@hilscher.com](mailto:de.support@hilscher.com)

### Subsidiaries

#### China

Hilscher Systemautomation (Shanghai) Co. Ltd.  
200010 Shanghai  
Phone: +86 (0) 21-6355-5161  
E-Mail: [info@hilscher.cn](mailto:info@hilscher.cn)

#### Support

Phone: +86 (0) 21-6355-5161  
E-Mail: [cn.support@hilscher.com](mailto:cn.support@hilscher.com)

#### France

Hilscher France S.a.r.l.  
69500 Bron  
Phone: +33 (0) 4 72 37 98 40  
E-Mail: [info@hilscher.fr](mailto:info@hilscher.fr)

#### Support

Phone: +33 (0) 4 72 37 98 40  
E-Mail: [fr.support@hilscher.com](mailto:fr.support@hilscher.com)

#### India

Hilscher India Pvt. Ltd.  
Pune, Delhi, Mumbai  
Phone: +91 8888 750 777  
E-Mail: [info@hilscher.in](mailto:info@hilscher.in)

#### Italy

Hilscher Italia S.r.l.  
20090 Vimodrone (MI)  
Phone: +39 02 25007068  
E-Mail: [info@hilscher.it](mailto:info@hilscher.it)

#### Support

Phone: +39 02 25007068  
E-Mail: [it.support@hilscher.com](mailto:it.support@hilscher.com)

#### Japan

Hilscher Japan KK  
Tokyo, 160-0022  
Phone: +81 (0) 3-5362-0521  
E-Mail: [info@hilscher.jp](mailto:info@hilscher.jp)

#### Support

Phone: +81 (0) 3-5362-0521  
E-Mail: [jp.support@hilscher.com](mailto:jp.support@hilscher.com)

#### Korea

Hilscher Korea Inc.  
Seongnam, Gyeonggi, 463-400  
Phone: +82 (0) 31-789-3715  
E-Mail: [info@hilscher.kr](mailto:info@hilscher.kr)

#### Switzerland

Hilscher Swiss GmbH  
4500 Solothurn  
Phone: +41 (0) 32 623 6633  
E-Mail: [info@hilscher.ch](mailto:info@hilscher.ch)

#### Support

Phone: +49 (0) 6190 9907-99  
E-Mail: [ch.support@hilscher.com](mailto:ch.support@hilscher.com)

#### USA

Hilscher North America, Inc.  
Lisle, IL 60532  
Phone: +1 630-505-5301  
E-Mail: [info@hilscher.us](mailto:info@hilscher.us)

#### Support

Phone: +1 630-505-5301  
E-Mail: [us.support@hilscher.com](mailto:us.support@hilscher.com)